

## PanelView Plus 6 Terminals

Catalog Numbers 2711P-K4M5A8, 2711P-K4M5D8, 2711P-K4M20A8, 2711P-K4M20D8, 2711P-K4C5A8, 2711P-B4C5A8, 2711P-K4C5D8, 2711P-B4C5D8, 2711P-K4C20A8, 2711P-B4C20A8, 2711P-K4C20D8, 2711P-B4C20D8, 2711P-K6M5A8, 2711P-T6M5A8, 2711P-B6M5A8, 2711P-K6M5D8, 2711P-T6M5D8, 2711P-B6M5D8, 2711P-K6M20A8, 2711P-T6M20A8, 2711P-B6M20A8, 2711P-K6M20D8, 2711P-T6M20D8, 2711P-B6M20D8, 2711P-K6C5A8, 2711P-T6C5A8, 2711P-B6C5A8, 2711P-K6C5D8, 2711P-T6C5D8, 2711P-B6C5D8, 2711P-K6C20A8, 2711P-T6C20A8, 2711P-B6C20A8, 2711P-K6C20D8, 2711P-T6C20D8, 2711P-B6C20D8, 2711P-K6C5A9, 2711P-T6C5A9, 2711P-B6C5A9, 2711P-K6C5D9, 2711P-T6C5D9, 2711P-B6C5D9, 2711P-K6C20A9, 2711P-T6C20A9, 2711P-B6C20A9, 2711P-K6C20D9, 2711P-T6C20D9, 2711P-B6C20D9, 2711P-K7C4D8, 2711P-T7C4D8, 2711P-B7C4D8, 2711P-K7C4D8K, 2711P-T7C4D8K, 2711P-B7C4D8K, 2711P-K7C4A8, 2711P-T7C4A8, 2711P-B7C4A8, 2711P-K10C4D8, 2711P-T10C4D8, 2711P-B10C4D8, 2711P-K10C4A8, 2711P-T10C4A8, 2711P-B10C4A8, 2711P-K12C4D8, 2711P-T12C4D8, 2711P-B12C4D8, 2711P-K12C4D8K, 2711P-T12C4D8K, 2711P-B12C4D8K, 2711P-K12C4A8, 2711P-T12C4A8, 2711P-B12C4A8, 2711P-K15C4D8, 2711P-T15C4D8, 2711P-B15C4D8, 2711P-K15C4A8, 2711P-T15C4A8, 2711P-B15C4A8, 2711P-K7C4D9, 2711P-T7C4D9, 2711P-B7C4D9, 2711P-K7C4A9, 2711P-T7C4A9, 2711P-B7C4A9, 2711P-K10C4D9, 2711P-T10C4D9, 2711P-B10C4D9, 2711P-K10C4A9, 2711P-T10C4A9, 2711P-B10C4A9, 2711P-K12C4D9, 2711P-T12C4D9, 2711P-B12C4D9, 2711P-K12C4A9, 2711P-T12C4A9, 2711P-B12C4A9, 2711P-K15C4D9, 2711P-T15C4D9, 2711P-B15C4D9, 2711P-K15C4A9, 2711P-T15C4A9, 2711P-B15C4A9



## Important User Information

Read this document and the documents listed in the additional resources section about installation, configuration, and operation of this equipment before you install, configure, operate, or maintain this product. Users are required to familiarize themselves with installation and wiring instructions in addition to requirements of all applicable codes, laws, and standards.

Activities including installation, adjustments, putting into service, use, assembly, disassembly, and maintenance are required to be carried out by suitably trained personnel in accordance with applicable code of practice.

If this equipment is used in a manner not specified by the manufacturer, the protection provided by the equipment may be impaired.

In no event will Rockwell Automation, Inc. be responsible or liable for indirect or consequential damages resulting from the use or application of this equipment.

The examples and diagrams in this manual are included solely for illustrative purposes. Because of the many variables and requirements associated with any particular installation, Rockwell Automation, Inc. cannot assume responsibility or liability for actual use based on the examples and diagrams.

No patent liability is assumed by Rockwell Automation, Inc. with respect to use of information, circuits, equipment, or software described in this manual.

Reproduction of the contents of this manual, in whole or in part, without written permission of Rockwell Automation, Inc., is prohibited.

Throughout this manual, when necessary, we use notes to make you aware of safety considerations.



**WARNING:** Identifies information about practices or circumstances that can cause an explosion in a hazardous environment, which may lead to personal injury or death, property damage, or economic loss.



**ATTENTION:** Identifies information about practices or circumstances that can lead to personal injury or death, property damage, or economic loss. Attentions help you identify a hazard, avoid a hazard, and recognize the consequence.

---

### IMPORTANT

Identifies information that is critical for successful application and understanding of the product.

---

Labels may also be on or inside the equipment to provide specific precautions.



**SHOCK HAZARD:** Labels may be on or inside the equipment, for example, a drive or motor, to alert people that dangerous voltage may be present.



**BURN HAZARD:** Labels may be on or inside the equipment, for example, a drive or motor, to alert people that surfaces may reach dangerous temperatures.



**ARC FLASH HAZARD:** Labels may be on or inside the equipment, for example, a motor control center, to alert people to potential Arc Flash. Arc Flash will cause severe injury or death. Wear proper Personal Protective Equipment (PPE). Follow ALL Regulatory requirements for safe work practices and for Personal Protective Equipment (PPE).

---

	<b>Preface</b>	
	Summary of Changes .....	7
	Package Contents .....	7
	Firmware Upgrades .....	7
	Additional Resources .....	7
	<b>Chapter 1</b>	
<b>Overview</b>	About the Terminals .....	9
	Windows CE Operating System .....	10
	Open versus Closed System .....	10
	Start-up Options .....	11
	Desktop Access .....	11
	Software Support .....	11
	400 and 600 Terminal Features .....	12
	700 to 1500 Terminal Features .....	15
	400/600 Terminal Selections .....	18
	700 to 1500 Terminal Selections .....	19
	Accessories .....	20
	<b>Chapter 2</b>	
<b>Install Terminal</b>	Mounting Clearances .....	28
	Panel Guidelines .....	28
	Panel Cutout Dimensions .....	28
	Product Dimensions .....	29
	Mount the 400/600 Terminal in a Panel .....	31
	Mount the 700 to 1500 Terminal in a Panel .....	33
	Remove and Install the Power Terminal Block .....	35
	DC Power Connections .....	36
	AC Power Connections .....	39
	Initial Startup .....	41
	Reset the Terminal .....	41
	<b>Chapter 3</b>	
<b>Configuration Mode</b>	Access Configuration Mode .....	43
	Terminal Settings .....	46
	Load and Run Application .....	48
	Start-up Options .....	49
	Desktop Access .....	52
	Communication Setup .....	56
	Ethernet Network Connections .....	58
	File Management .....	62
	Display Settings .....	65
	Input Device Settings .....	67
	Configure Print Options .....	70

Check Integrity of Application Files .....	72
Configure Diagnostics .....	73
View and Clear the System Event Log .....	74
System Information .....	74
Enable or Disable the Alarm Display .....	76
Time and Date Settings .....	77
Regional Settings .....	79
Font Linking .....	82

#### **Chapter 4**

### **Windows CE Operating System**

Windows CE 6.0 Standard Features .....	83
Windows CE 6.0 with Extended Features .....	85
Windows Explorer .....	86
Taskbar .....	86
Input Panels .....	86
Windows Control Panel .....	87
Backup and Restore .....	88
Hardware Monitor .....	91
Keypad Properties .....	93
Touch Properties .....	93
Display Properties .....	94
Logo Manager .....	96
System Information .....	97
User Accounts .....	100
Services .....	101
Network Server Configuration .....	102
Printer Support .....	111
PDF Reader .....	114
Image Viewer .....	115

#### **Chapter 5**

### **Install and Replace Components**

Required Tools .....	117
Install or Replace the Logic Module .....	118
Install or Replace a Communication Module .....	119
Replace the Display Module .....	121
Replace the Bezel .....	122
Replace the Backlight .....	124
Replace the Battery .....	128
Install the AC Power Supply Module .....	130
Remove the Product ID Label .....	132
Replace the Keypad Legend Inserts .....	132
Load an SD Card .....	134
Clean the Display .....	134



	<b>Chapter 6</b>	
<b>Terminal Connections</b>	USB Ports .....	138
	Ethernet Connections .....	140
	Serial Connections .....	142
	DH-485/DH+ Communication Module .....	145
	ControlNet Communication Module .....	148
	Controller Connections .....	151
	<b>Chapter 7</b>	
<b>Firmware Upgrades</b>	Terminal Firmware .....	153
	Download Firmware Files .....	154
	Firmware Upgrade Wizard .....	154
	Upgrade Terminal Firmware from a Storage Device .....	155
	Upgrade Terminal Firmware over the Network .....	158
	<b>Chapter 8</b>	
<b>Troubleshooting</b>	Status Indicators .....	161
	Terminal Does Not Start Properly .....	162
	Start-up Messages and Codes .....	164
	Check Terminal Components .....	166
	Ethernet Connection .....	167
	Program Launcher ActiveX Control .....	168
	Application Does Not Run .....	168
	Configuration Mode Access .....	168
	File System Errors .....	169
	Advanced Diagnostics .....	169
	Access Maintenance Operations .....	170
	Restore Factory Defaults .....	172
	<b>Appendix A</b>	
<b>Fonts Resident on Terminal</b>	True Type Fonts .....	175
	<b>Appendix B</b>	
<b>Outdoor Installations for High-bright Displays</b>	Important Considerations .....	177
	Using an Antiglare Overlay .....	177
	Using a Solar Visor .....	177
	Selecting an Enclosure .....	178
	Backlight Considerations .....	178
	Orientation of the Terminal .....	178
	<b>Index</b>	

**Notes:**

This manual describes how to install, configure, operate, and troubleshoot PanelView™ Plus 6 terminals. It does not provide procedures on how to create applications that run on the terminal.

You need to do the following:

- Use FactoryTalk® View Studio for Machine Edition software to create an HMI application to run in the terminal.
- Create ladder logic to interact with the HMI application.

## Summary of Changes

This publication contains new and updated information as indicated in the following table.

Topic	Pages
Updated the power supply catalog number.	16, 23, 37
Added catalog numbers for the new SDHC cards.	16, 16

## Package Contents

This product is shipped with the following items:

- Terminal with FactoryTalk View Machine Edition runtime software installed and activated
- Product information
- Mounting levers for installing 400 and 600 terminals
- Mounting clips for installing 700 to 1500 terminals
- Panel cutout template

## Firmware Upgrades

For the latest firmware upgrades and other downloads for PanelView Plus 6 terminals, go to <http://www.rockwellautomation.com/support> and click Firmware Updates.

## Additional Resources

These documents contain additional information concerning related products from Rockwell Automation.

Resource	Description
PanelView Plus Specifications Technical Data, publication <a href="#">2711P-TD005</a>	Provides technical specifications, environmental specifications, and certifications for the PanelView Plus 6 platform.
Industrial Automation Wiring and Grounding Guidelines, publication <a href="#">1770-4.1</a>	Provides general guidelines for installing a Rockwell Automation® industrial system.
Product Certifications website, <a href="http://rok.auto/certifications">rok.auto/certifications</a>	Provides declarations of conformity, certificates, and other certification details.

You can view or download publications at <http://www.rockwellautomation.com/global/literature-library/overview.page>.

**Notes:**

## Overview

<b>Topic</b>	<b>Page</b>
Windows CE Operating System	10
Open versus Closed System	10
Desktop Access	11
Software Support	11
400 and 600 Terminal Features	12
700 to 1500 Terminal Features	15
400/600 Terminal Selections	18
700 to 1500 Terminal Selections	19
Accessories	20

## About the Terminals

PanelView™ Plus 6 terminals are operator interface devices that run HMI machine-level applications in an industrial environment. The displays range in size from 4 to 15 inches. These devices are used to monitor, control, or display information graphically, letting operators quickly understand the status of their application.









This platform is programmed by using common development software that provides multilingual support, and integrates into systems with Rockwell Automation controllers including preferred Logix controllers.

## Windows CE Operating System

PanelView Plus 6 terminals run the Windows CE operating system (OS), providing the foundational OS elements for the majority of user needs.

For users with more complex application requirements, some of the terminals offer optional, extended features and file viewers.

**Table 1 - Operating System Features**

Features	400 Terminals	600 Terminals		700 to 1500 Terminals	
Cat. No.	2711P-xxxx8	2711P-xxxx8	2711P-xxxx9	2711P-xxxx8 2711P-RP8x	2711P-xxxx9 2711P-RP9x
<b>Standard Features</b>					
FTP server	X	X	X	X	X
VNC client/server	X	X	X	X	X
ActiveX controls <sup>(1)</sup>	X	X	X	X	X
Third-party device support	X	X	X	X	X
PDF reader 	X	X	X	X	X
<b>Optional Extended Features</b>					
Web browser - Internet Explorer 	—	—	X	—	X
Remote desktop connection 	—	—	X <sup>(2)</sup>	—	X
Media player 	—	—	X	—	X
Microsoft Office file viewers					
• PowerPoint 	—	—	X	—	X
• Excel 	—	—	X	—	X
• Word 	—	—	X	—	X
WordPad text editor 	—	—	X	—	X

(1) Refer to [Display FactoryTalk View ME Station Information on page 76](#) for a list of ActiveX controls loaded on a terminal.

(2) The remote desktop connection is not currently supported on PanelView Plus 6 - 600 terminals with extended features.

## Open versus Closed System

The terminals can be configured to run an open or closed desktop environment:

- An open system launches the Windows Explorer desktop on startup. The system is configurable via the control panel and supports Windows operations.
- A closed system launches a FactoryTalk® View Machine Edition application on startup and restricts access to the Windows Explorer desktop.

All terminals are shipped as closed systems restricting access to the desktop. The first time you start the system, the terminal launches FactoryTalk View ME Station Configuration mode. At this point, you can change the start-up option and allow desktop access.

## Start-up Options

You can configure the terminal to perform one of three actions at startup:

- Launch a FactoryTalk View Machine Edition HMI application.
- Launch the FactoryTalk View Machine Edition Configuration mode of the terminal where you load and run applications, configure start-up options and terminal settings, and enable or disable desktop access.
- Launch the Windows Explorer desktop.

The factory default state and start-up option following a firmware upgrade is to launch the terminal in Configuration mode. Refer to [Start-up Options on page 49](#) for details on how to change the start-up option.

## Desktop Access

Any of the terminals can be configured to allow or restrict desktop access. From the desktop, you can perform system and control panel operations, or run third-party applications. Terminals with optional, extended features (catalog numbers ending in 9) can additionally run viewers, media players, and launch the web browser. You can even allow access temporarily to perform specific tasks, then disable desktop access to prevent unauthorized changes.

**TIP** All terminals are initially shipped with desktop access disabled.

Refer to [Desktop Access on page 52](#) for details on how to modify desktop access.

---

**IMPORTANT** Desktop access does not change the feature set of your terminal. If you have a terminal with a catalog number ending in 8, opening the desktop does not give you access to extended features and file viewers.

---

## Software Support

The table lists software supported on the terminals.

**Table 2 - PanelView Plus 6 Software Support**

Software	Description	Version
FactoryTalk View Machine Edition Station	Runtime environment for FactoryTalk View Machine Edition .mer applications. Machine Edition Station is preloaded on each terminal and does not require FactoryTalk View activation.	<ul style="list-style-type: none"> <li>• 6.10 or later (400 and 600 terminals)</li> <li>• 6.0 or later (700 to 1500 terminals)</li> </ul>
FactoryTalk View Studio for Machine Edition	Configuration software for developing HMI applications that run on PanelView Plus 6 terminals. RSLinx <sup>®</sup> Enterprise software is included with FactoryTalk View Studio software and loaded during installation.	
FactoryTalk ViewPoint (700 to 1500 terminals only)	Add-on capability provided with FactoryTalk View Studio software: <ul style="list-style-type: none"> <li>• This web-based, thin-client solution lets manufacturers or casual users monitor or download changes to a running Machine Edition application from remote locations via an Internet browser.</li> <li>• A single license is embedded with each terminal supporting a single client connection to terminal. No additional software is required.</li> </ul>	1.2 or later
Windows CE 6.0 OS	Operating system that runs on all terminals.	6.0



## 400 and 600 Terminal Features

Both the 400 and 600 terminals provide these communication options:

- RS-232 serial port only or
- Ethernet port and RS-232 serial port

**Figure 1 - 400 Keypad or Keypad/Touch Terminals**

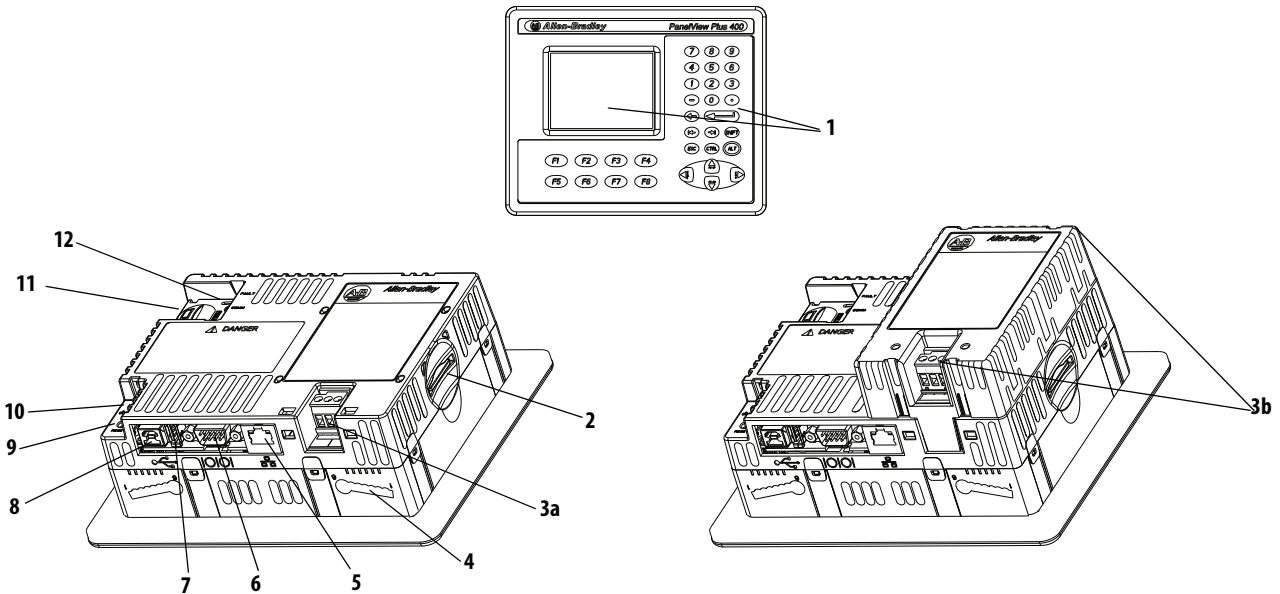

**Table 3 - PanelView Plus 6 - 400 Terminal Components**

Item	Component
1	3.5-in. grayscale or color display with one of these operator input options: <ul style="list-style-type: none"> <li>• Keypad</li> <li>• Combination keypad and touch screen</li> </ul>
2	Secure Digital (SD) card slot supporting cat. no. 1784-SDx cards
3a	DC power input, nonisolated <sup>(1)</sup> 24V DC nom (18...30V DC)
3b	AC power supply module with AC power input <sup>(1)</sup> 100...240V AC (50...60 Hz)
4	Mounting slots (four)
5	Ethernet port for controller communication, 10/100Base-T, Auto MDI/MDI-X <sup>(2)</sup>
6	RS-232 serial port for controller communication, printing, or file transfers
7	One USB 2.0 high-speed (type A) host port for attaching USB peripherals including mouse, keyboard, printer, and USB drives that are hot-swappable in nonhazardous locations
8	One USB 2.0 high-speed (type B) device port for connecting a host computer
9	Reset switch to reset the terminal without having to power off and on
10	Default switch to access maintenance operations such as restoring factory defaults
11	Battery compartment
12	Indicators provide communication and fault status

(1) Presence of a DC power input or AC power supply module is catalog number dependent. Removing the AC power supply module voids the terminal warranty.

(2) Presence of Ethernet port is catalog number dependent.

Figure 2 - 600 Touch Terminals

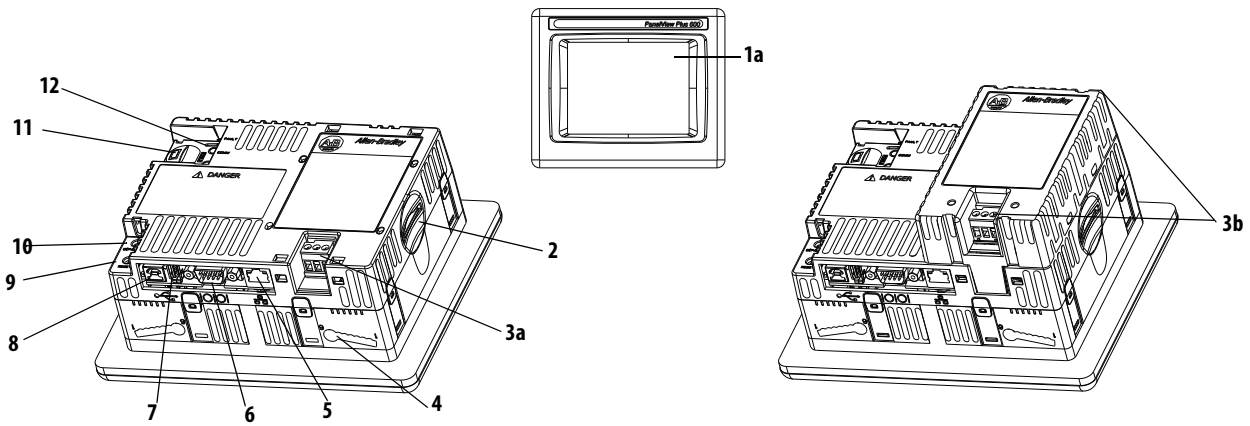

Figure 3 - 600 Keypad or Keypad/Touch Terminals

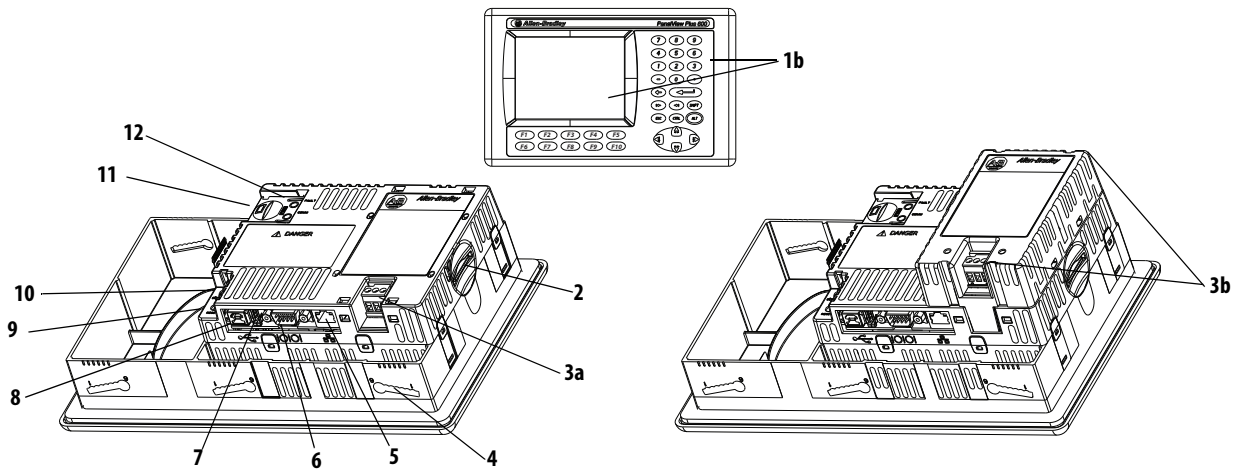

Table 4 - PanelView Plus 6 - 600 Terminal Components

Item	Component	Item	Component
1a	5.7-in. color or grayscale display with a touch screen	6	RS-232 serial port for controller communication, printing, or file transfers
1b	5.7-in. color or grayscale display with either a: <ul style="list-style-type: none"> <li>• Keypad</li> <li>• Combination keypad and touch screen</li> </ul>	7	One USB 2.0 high-speed (type A) host port for attaching USB peripherals including mouse, keyboard, printer, and USB drives that are hot-swappable in nonhazardous locations
2	Secure Digital (SD) card slot supporting cat. no. 1784-SDx cards	8	One USB 2.0 high-speed (type B) device port for connecting a host computer
3a	DC power input, nonisolated <sup>(1)</sup> 24V DC nom (18...30V DC)	9	Reset switch to reset the terminal without having to power off and on
3b	AC power supply module with AC power input <sup>(1)</sup> 100...240V AC (50...60 Hz)	10	Default switch to access maintenance operations such as restoring factory defaults
4	Mounting slots (four on touch terminals; six on keypad terminals)	11	Battery compartment
5	Ethernet port for controller communication, 10/100Base-T, Auto MDI/MDI-X <sup>(2)</sup>	12	Indicators provide communication and fault status

(1) Presence of a DC power input or the AC power supply module is catalog number dependent. Removing the AC power supply module voids the terminal warranty.

(2) Presence of Ethernet port is catalog number dependent.

The terminals feature grayscale or color LCD displays with these input options.

**Table 5 - Operator Input Options**

Terminal	Display Type	Keypad	Touch	Key and Touch
400	Grayscale	•		
	Color	•		•
600	Grayscale	•	•	•
	Color	•	•	•

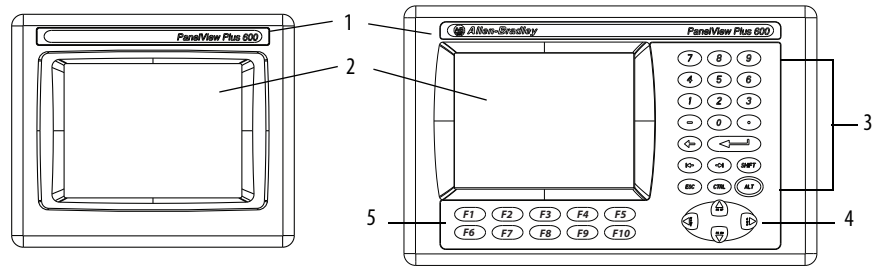

**Table 6 - Display and Operator Input Features**

Item	Feature	Description
1	Product label	Product identification label can be replaced with custom label.
2	Display/touch screen	Color or grayscale display with or without a resistive, 4-wire, touch screen (catalog number dependent)
3	Numeric keypad	0 . . 9, Backspace, Enter, Left and Right Tab, Esc, Shift, Ctrl, Alt keys
4	Navigation keys	Use arrow keys for navigation. Use Alt+arrow to initiate these functions: <ul style="list-style-type: none"> <li>• Alt+left arrow (Home), Alt+right arrow (End)</li> <li>• Alt+up arrow (Page Up), Alt+down arrow (Page Down)</li> </ul>
5	Function keys	Keys that can be configured in the application to perform operations. For example, F1 can be configured to navigate to another screen. <ul style="list-style-type: none"> <li>• F1 . . . F8</li> <li>• F1 . . . F10</li> </ul>



**ATTENTION:** Use a finger or gloved finger to operate the keypad. To operate the touch screen, use a finger, gloved-finger or plastic stylus with a minimum tip radius of 1.3 mm (0.051 in.). Using any other object or tool can damage the keypad or touch screen.



**ATTENTION:** Do not carry out multiple operations simultaneously. Doing so can result in unintended operation:

- Touch only one operating element on the screen with one finger at one time.
- Press only one key on the terminal at one time.

## 700 to 1500 Terminal Features

The larger 700 to 1500 terminals consist of modular components ordered separately or as configured terminals. The modular components consist of the following:

- Display module
- Logic module
- Optional communication module

These components provide for flexible configuration, installation, and upgrades. You can order a factory-assembled unit with a single catalog number or separate components for field installation.

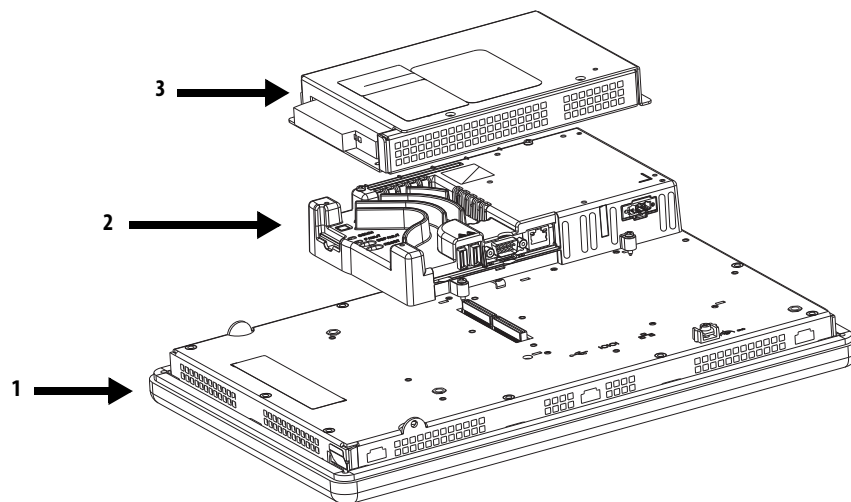

**Table 7 - Modular Components**

Item	Terminal Component	Description	Options for Environmental Conditions
1	Display module	Flat panel, color graphic display in four sizes with keypad, touch-screen, or combination keypad/touch-screen input: <ul style="list-style-type: none"> <li>• 700 (6.5-in.)</li> <li>• 1000 (10.4-in.)</li> <li>• 1250 (12.1-in.)</li> <li>• 1500 (15-in.)</li> </ul>	Display modules are also available with these characteristics: <ul style="list-style-type: none"> <li>• Marine-certified</li> <li>• Conformal-coated</li> <li>• High-bright display for outdoor use</li> <li>• Built-in antiglare overlay</li> </ul>
2	Logic module	The logic module has these hardware features: <ul style="list-style-type: none"> <li>• Power input, AC or DC</li> <li>• RS-232 serial port</li> <li>• Ethernet port</li> <li>• 2 USB 2.0 host ports</li> <li>• Network interface for optional communication module</li> <li>• 512 MB RAM memory and 512 MB nonvolatile memory (approx. 79 MB free user memory)</li> <li>• Secure Digital (SD) card slot</li> <li>• Battery-backed real-time clock</li> <li>• Status indicators</li> <li>• Reset switches</li> <li>• Single PCI slot</li> </ul>	Logic modules are also available with these characteristics: <ul style="list-style-type: none"> <li>• Marine-certified</li> <li>• Conformal-coated</li> </ul>
3	Communication module	Optional module for communication with these networks: <ul style="list-style-type: none"> <li>• DH+™/DH-485</li> <li>• ControlNet scheduled and unscheduled</li> <li>• Ethernet</li> </ul>	Communication modules are also available with these characteristics: <ul style="list-style-type: none"> <li>• Marine-certified</li> <li>• Conformal-coated</li> </ul>

## Configured Terminals

A configured terminal, ordered as a single-catalog number, has a display module and logic module.

An optional DH+/DH-485, ControlNet, or Ethernet communication module can be added later for additional network capabilities.

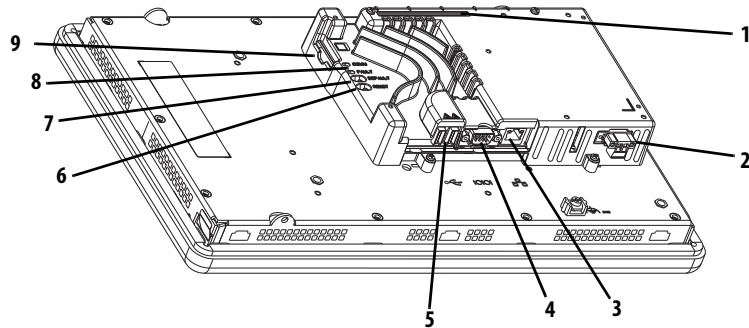

**Table 8 - Logic Module Features**

Item	Feature
1	Network interface connector for optional communication module
2	AC or DC power input <sup>(1)</sup> <ul style="list-style-type: none"> <li>• Isolated 18...32V DC</li> <li>• 100...240V AC</li> </ul>
3	Ethernet port for controller communication, 10/100 BaseT, Auto MDI/MDI-X
4	RS-232 serial port for file transfers, printing, and controller communication
5	Two USB 2.0 high-speed (type A) host ports for attaching USB devices including mouse, keyboard, printer, and USB drives that are hot-swappable in nonhazardous locations
6	Reset switch to reset the terminal without having to power on and off
7	Default switch to access maintenance operations such as restoring factory defaults
8	Indicators provide communication and fault status
9	Secure Digital (SD) card slot supporting cat. no. 1784-SDx and 1784-SDHCx cards

(1) For DC applications using AC power, an external, remote AC-to-DC power supply, cat. no. 1606-XLE120E, is available for DIN-rail mounting.

## Operator Input

All 700 to 1500 display modules have TFT color, graphic displays with either keypad, touch screen, or combination keypad/touch-screen input. Common features and firmware provide for easy migration to a larger display:

- Eight-wire resistive touch screens are extremely accurate for operator interfaces. When a point on the touch screen is pressed, the layers connect and change the electrical current, which is then registered and processed.
- All keypad or combination keypad/touch-screen displays are similar except for the number of functions keys.

To meet the requirements of specific environmental conditions, high-bright displays, marine-certified displays, and conformal-coated displays are also available. Plus, you can order field replaceable bezels.

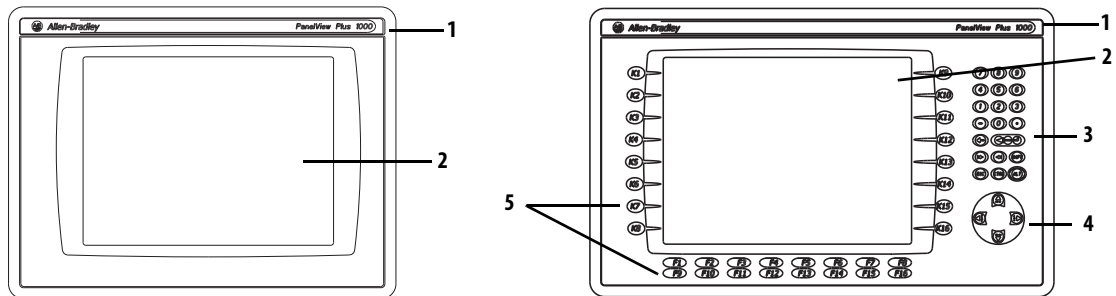

**ATTENTION:** Keypad Operation - Use only a finger or gloved finger to operate. Touch screen Operation - Use only a finger, gloved finger, or plastic stylus with a minimum tip radius of 1.3mm (0.051 in.) to operate. Using any other object or tool not described above may cause damage to the device and is not warranted by Rockwell Automation.



**ATTENTION:** Do not carry out multiple operations simultaneously. Doing so can result in unintended operation:

- Touch only one operating element on the screen with one finger at one time.
- Press only one key on the terminal at one time.

**Table 9 - Display Features**

Item	Feature	Description
1	Replaceable ID Label	Product identification label can be replaced with custom label.
2	Display	Analog resistive touch screen applies to touch-screen or combination keypad/touch-screen terminals.
3	Numeric keypad	0 . . 9, -, Backspace, Enter, Left and Right tab, Shift, Esc, Ctrl, Alt keys.
4	Navigation keys	Use arrow keys for navigation. Use Alt+arrow to initiate these functions: <ul style="list-style-type: none"> <li>• Alt+left arrow (Home), Alt+right arrow (End)</li> <li>• Alt+up arrow (Page Up), Alt+down arrow (Page Down)</li> </ul>
5	Function keys 700 F1 ...F10, K1...K12 1000 F1 ...F16, K1...K16 1250 F1 ...F20, K1...K20 1500 F1 ...F20, K1...K20	Keys that can be configured in the application to perform operations. For example, F1 can be configured to navigate to another screen. Replaceable legends are available to customize the function key labels.

## 400/600 Terminal Selections

The table shows the catalog number breakdown for the 400 and 600 terminals.

Bulletin	Input Type	Display Size	Display Type	Communication	Power	Operating System
2711P-	K = Keypad B = Keypad and Touch T = Touch	4 = 3.5 in. 6 = 5.7 in.	C = Color M = Grayscale	5 = RS-232, USB 20 = Ethernet, RS-232, USB	A = AC D = DC	8 = Windows CE 6.0 9 = Windows CE 6.0 with extended features

**Table 10 - PanelView Plus 6 - 400 Terminals without Extended Features**

Cat. Nos.		Display		Communication Ports		USB Ports		Input Power	Memory (MB) <sup>(1)</sup>	
Keypad	Keypad and Touch	Size	Type	RS-232	Ethernet	Host	Device		RAM	Nonvolatile
2711P-K4M5A8	—	3.5-in.	Grayscale	•		•	•	AC	256	512 (approx. 73 MB free user memory)
2711P-K4M5D8	—			•		•	•	DC		
2711P-K4M20A8	—			•	•	•	•	AC		
2711P-K4M20D8	—			•	•	•	•	DC		
2711P-K4C5A8	2711P-B4C5A8	3.5-in.	Color	•		•	•	AC		
2711P-K4C5D8	2711P-B4C5D8			•		•	•	DC		
2711P-K4C20A8	2711P-B4C20A8			•	•	•	•	AC		
2711P-K4C20D8	2711P-B4C20D8			•	•	•	•	DC		

(1) The terminals support FactoryTalk View Machine Edition software, version 6.10 or later, and the Windows CE 6.0 operating system.

**Table 11 - PanelView Plus 6 - 600 Terminals without Extended Features**

Cat. Nos.			Display		Communication Ports		USB Ports		Input Power	Memory (MB) <sup>(1)</sup>	
Keypad	Touch	Keypad and Touch	Size	Type	RS-232	Ethernet	Host	Device		RAM	Nonvolatile
2711P-K6M5A8	2711P-T6M5A8	2711P-B6M5A8	5.7-in.	Grayscale	•		•	•	AC	256	512 (approx. 73 MB free user memory)
2711P-K6M5D8	2711P-T6M5D8	2711P-B6M5D8			•		•	•	DC		
2711P-K6M20A8	2711P-T6M20A8	2711P-B6M20A8			•	•	•	•	AC		
2711P-K6M20D8	2711P-T6M20D8	2711P-B6M20D8			•	•	•	•	DC		
2711P-K6C5A8	2711P-T6C5A8	2711P-B6C5A8	5.7-in.	Color	•		•	•	AC		
2711P-K6C5D8	2711P-T6C5D8	2711P-B6C5D8			•		•	•	DC		
2711P-K6C20A8	2711P-T6C20A8	2711P-B6C20A8			•	•	•	•	AC		
2711P-K6C20D8	2711P-T6C20D8	2711P-B6C20D8			•	•	•	•	DC		

(1) The terminals support FactoryTalk View Machine Edition software, version 6.10 or later, and the Windows CE 6.0 operating system.

**Table 12 - PanelView Plus 6 - 600 Terminals with Extended Features**

Cat. Nos.			Display		Communication		USB Ports		Input Power	Memory (MB) <sup>(1)</sup>	
Keypad	Touch	Keypad and Touch	Size	Type	RS-232	Ethernet	Host	Device		RAM	Nonvolatile
2711P-K6C5A9	2711P-T6C5A9	2711P-B6C5A9	5.7-in.	Color	•		•	•	AC	256	512 (approx. 73 MB free user memory)
2711P-K6C5D9	2711P-T6C5D9	2711P-B6C5D9			•		•	•	DC		
2711P-K6C20A9	2711P-T6C20A9	2711P-B6C20A9			•	•	•	•	AC		
2711P-K6C20D9	2711P-T6C20D9	2711P-B6C20D9			•	•	•	•	DC		

(1) The terminals support FactoryTalk View Machine Edition software, version 6.10 or later, and the Windows CE 6.0 operating system with extended features and file viewers.



## 700 to 1500 Terminal Selections

The table shows the catalog number breakdown for the 700 to 1500 terminals.

Bulletin	Input Type	Display Size	Display Type	Communication <sup>(1)</sup>	Power	Operating System	Special Option
2711P-	K = Keypad	7 = 6.5 in.	C = Color	4 = Ethernet, RS-232 & (2) USB	A = AC	8 = Windows CE 6.0	K = Conformal-Coated
	T = Touch	10 = 10.4 in.			D = DC	9 = Windows CE 6.0 with extended features	
	B = Keypad/Touch	12 = 12.1 in.					
		15 = 15 in.					

(1) Optional communication modules are available as separate catalog numbers.

**Table 13 - PanelView Plus 6 - 700 to 1500 Terminals without Extended Features**

Cat. No.			Display		Communication		Input Power	Memory (MB) <sup>(1)</sup>	
Keypad	Touch	Keypad/Touch	Size	Type	RS-232	Ethernet		RAM	Nonvolatile
<b>700 Model</b>									
2711P-K7C4D8	2711P-T7C4D8	2711P-B7C4D8	6.5-in.	Color	•	•	DC	512	512 (approx. 79 MB free user memory)
–	2711P-T7C4D8K	–			•	•	DC		
2711P-K7C4A8	2711P-T7C4A8	2711P-B7C4A8			•	•	AC		
<b>1000 Model</b>									
2711P-K10C4D8	2711P-T10C4D8	2711P-B10C4D8	10.4-in.	Color	•	•	DC	512	512 (approx. 79 MB free user memory)
2711P-K10C4A8	2711P-T10C4A8	2711P-B10C4A8			•	•	AC		
<b>1250 Model</b>									
2711P-K12C4D8	2711P-T12C4D8	2711P-B12C4D8	12.1-in.	Color	•	•	DC	512	512 (approx. 79 MB free user memory)
–	2711P-T12C4D8K	–			•	•	DC		
2711P-K12C4A8	2711P-T12C4A8	2711P-B12C4A8			•	•	AC		
<b>1500 Model</b>									
2711P-K15C4D8	2711P-T15C4D8	2711P-B15C4D8	15-in.	Color	•	•	DC	512	512 (approx. 79 MB free user memory)
2711P-K15C4A8	2711P-T15C4A8	2711P-B15C4A8			•	•	AC		

(1) The logic module supports FactoryTalk View Machine Edition software, version 6.0 or later, FactoryTalk ViewPoint software version 1.2 or later, and the Windows CE 6.0 operating system.

**Table 14 - PanelView Plus 6 - 700 to 1500 Terminals with Extended Features**

Cat. No.			Display		Communication		Input Power	Memory (MB) <sup>(1)</sup>	
Keypad	Touch	Keypad/Touch	Size	Type	RS-232	Ethernet		RAM	Nonvolatile
<b>700 Model</b>									
2711P-K7C4D9	2711P-T7C4D9	2711P-B7C4D9	6.5-in.	Color	•	•	DC	512	512 (approx. 79 MB free user memory)
2711P-K7C4A9	2711P-T7C4A9	2711P-B7C4A9			•	•	AC		
<b>1000 Model</b>									
2711P-K10C4D9	2711P-T10C4D9	2711P-B10C4D9	10.4-in	Color	•	•	DC	512	512 (approx. 79 MB free user memory)
2711P-K10C4A9	2711P-T10C4A9	2711P-B10C4A9			•	•	AC		
<b>1250 Model</b>									
2711P-K12C4D9	2711P-T12C4D9	2711P-B12C4D9	12.1-in	Color	•	•	DC	512	512 (approx. 79 MB free user memory)
2711P-K12C4A9	2711P-T12C4A9	2711P-B12C4A9			•	•	AC		
<b>1500 Model</b>									
2711P-K15C4D9	2711P-T15C4D9	2711P-B15C4D9	15-in.	Color	•	•	DC	512	512 (approx. 79 MB free user memory)
2711P-K15C4A9	2711P-T15C4A9	2711P-B15C4A9			•	•	AC		

(1) The logic module supports FactoryTalk View Machine Edition software, version 6.0 or later, FactoryTalk ViewPoint software version 1.2 or later, and the Windows CE 6.0 operating system with extended features and file viewers.

## Accessories

Tables 15...28 list accessories for the PanelView Plus 6 terminals.

**Table 15 - Display Modules - 700 to 1500 Terminals**

Cat. No.	Input Type	Display	Marine Certified	Conformal Coated	Built-in Antiglare Overlay
<b>700 Model</b>					
2711P-RDK7C	Keypad	7-in. color			
2711P-RDK7CK	Keypad		•		
2711P-RDT7C	Touch				
2711P-RDT7CK	Touch		•		
2711P-RDT7CM	Touch		•		
2711P-RDB7C	Keypad/Touch				
2711P-RDB7CK	Keypad/Touch		•		
2711P-RDB7CM	Keypad/Touch		•		
<b>1000 Model</b>					
2711P-RDK10C	Keypad	10-4 in. color			
2711P-RDT10C	Touch				
2711P-RDT10CM	Touch		•		
2711P-RDB10C	Keypad/Touch				
2711P-RDB10CM	Keypad/Touch		•		

Table 15 - Display Modules - 700 to 1500 Terminals

Cat. No.	Input Type	Display	Marine Certified	Conformal Coated	Built-in Antiglare Overlay
<b>1250 Model</b>					
2711P-RDK12C	Keypad	12.1-in. color			
2711P-RDK12CK	Keypad			•	
2711P-RDT12C	Touch				
2711P-RDT12CK	Touch			•	
2711P-RDT12H <sup>(1)</sup>	Keypad/Touch				
2711P-RDT12AG	Touch				•
2711P-RDB12C	Keypad/Touch				
2711P-RDB12CK	Keypad/Touch			•	
<b>1500 Model</b>					
2711P-RDK15C	Keypad	15-in. color			
2711P-RDT15C	Touch				
2711P-RDT15AG	Touch				•
2711P-RDB15C	Keypad/Touch				

(1) H at end of cat. no. refers to 1250 High-bright display module.

Table 16 - Logic Modules - 700 to 1500 Terminals

Cat. No.	Power Input	Memory RAM/Nonvolatile	Communication	Marine Certified	Conformal Coated	Included Software
<b>Without Standard Features</b>						
2711P-RP8A	AC	512 MB/512 MB (approximately 79 MB free user memory)	<ul style="list-style-type: none"> <li>Ethernet</li> <li>RS-232</li> <li>Network interface for communication module</li> </ul>	•		<ul style="list-style-type: none"> <li>Windows CE 6.0 operating system</li> <li>FactoryTalk View Machine Edition runtime, version 6.0 or later</li> <li>FactoryTalk ViewPoint software, version 1.2 or later</li> </ul>
2711P-RP8D	DC			•		
2711P-RP8DK	DC			•	•	
<b>With Extended Features</b>						
2711P-RP9A	AC	512 MB/512 MB (approximately 79 MB free user memory)	<ul style="list-style-type: none"> <li>Ethernet</li> <li>RS-232</li> <li>Network interface communication module</li> </ul>	•		<ul style="list-style-type: none"> <li>Windows CE 6.0 operating system with extended features and file viewers</li> <li>FactoryTalk View Machine Edition runtime, version 6.0 or later</li> <li>FactoryTalk ViewPoint software, version 1.2 or later</li> </ul>
2711P-RP9D	DC			•		
2711P-RP9DK	DC			•	•	

Table 17 - Communication Modules - 700 to 1500 Terminals

Cat. No.	Communication				Conformal Coated	Marine Certified
	Ethernet	DH+	DH-485	ControlNet <sup>(2)</sup>		
2711P-RN6		•	•			
2711P-RN6K		•	•		•	
2711P-RN15S				•		•
2711P-RN15SK				•	•	
2711P-RN20 <sup>(1)</sup>	•					

(1) All terminals have an Ethernet port. The cat. no. 2711P-RN20 module provides an additional Ethernet port.

(2) Scheduled and unscheduled communication.

**Table 18 - Secure Digital (SD) Cards<sup>(1)</sup>**

Cat. No.	Terminal Model	Description
1784-SD1	All terminals	1 GB Secure Digital (SD) card
1784-SD2		2 GB Secure Digital (SD) card
1784-SDHC8		8 GB High Capacity Secure Digital (SD) card
1784-SDHC32		32 GB High Capacity Secure Digital (SD) card
2711C-RCSD		USB to SD adapter for secure digital (SD) card

(1) To help reduce the chance of corruption when you use SD Cards or USB drives with the terminal, Rockwell Automation recommends that you use only the above SD card catalog numbers.

**Table 19 - CCFL Backlight Replacements<sup>(1)</sup>**

Cat. No.	Terminal Model	Series	Number of CCFL Backlights
2711P-RL7C	700	A and B	1
2711P-RL7C2		C and D	1
2711P-RL10C	1000	A	1
2711P-RL10C2		B and C	1
2711P-RL12C	1250	A and B	2
2711P-RL12C2		C	1
2711P-RL15C	1500	B	2

(1) These CCFL-backlight replacement catalog numbers do not apply to LED displays.

**Table 20 - Antiglare Overlays**

Cat. No. <sup>(1)</sup>	Terminal Model	Operator Input		
		Keypad	Touch	Key/Touch
2711P-RGB4	400 grayscale or color	•		•
2711P-RGK6	600 grayscale or color	•		•
2711P-RGT6			•	
2711P-RGK7	700 color	•		•
2711P-RGT7			•	
2711P-RGK10	1000 color	•		•
2711P-RGT10			•	
2711P-RGK12	1250 color	•		•
2711P-RGT12			•	
2711P-RGK15	1500 color	•		•
2711P-RGT15			•	

(1) Three overlays are shipped with each catalog number.

**Table 21 - Solar Visor**

Cat. No.	Terminal Model	Description
2711P-RVT12	1250	Solar visor for 1250 high-bright display module, cat. no. 2711P-RDT12H

**Table 22 - Function Key Legend Kits**

Cat. No.	Terminal Model <sup>(1)</sup>	Description
2711P-RFK6	600 keypad	Blank legend inserts and software
2711P-RFK7	700 keypad	
2711P-RFK10	1000 keypad	
2711P-RFK12	1250 keypad	
2711P-RFK15	1500 keypad	

(1) Applies to keypad and keypad/touch-screen terminals.

**Table 23 - Mounting Hardware**

Cat. No.	Terminal Model	Description	Quantity
2711P-RTFC	400 or 600	Replacement mounting levers	8
2711P-RTMC	700 to 1500	Replacement Mounting clips	8

**Table 24 - Replacement Battery**

Cat. No.	Terminal Model	Description
2711P-RY2032	All terminals	Replacement CR2032 coin-cell equivalent battery

**Table 25 - Cables**

Cat. No.	Terminal Model	Description	Length
2711C-CBL-UU02 <sup>(1)</sup>	700 to 1500	Programming cable that connects the USB device port of the terminal to a USB host port of a computer	2 m (6.5 ft)
6189V-USBCBL2	400 and 600	Programming cable that connects the USB device port of the terminal to a USB host port of a computer	1.8 m (6 ft)

(1) Only for Series A terminals with a mini-USB port, type B.

**Table 26 - Power Supply and Power Terminal Blocks**

Cat. No.	Terminal Model	Description	Quantity
1606-XLE120E	All terminals	DIN-rail power supply, AC-to-DC, 100...240V AC, 50...60 Hz	1
2711P-RVAC	400 and 600	AC power terminal block	10
2711P-6RSA		AC module converts a DC-powered terminal to AC power	1
2711P-TBDC		DC power terminal block	10
2711P-RTBAC3	700 to 1500	AC power terminal block	10
2711P-RTBDC2		DC power terminal block	10

**Table 27 - Bezel Replacements**

Cat. No.	Terminal Model	Operator Input		
		Keypad	Touch	Key/Touch
2711P-RBK7	700	•		
2711P-RBT7			•	
2711P-RBB7				•
2711P-RBK10	1000	•		
2711P-RBT10			•	
2711P-RBB10				•
2711P-RBK12	1250	•		
2711P-RBT12			•	
2711P-RBT12H <sup>(1)</sup>			•	
2711P-RBB12				•
2711P-RBK15	1500	•		
2711P-RBT15			•	
2711P-RBB15				•

(1) Applies to the cat. no. 2711P-RDT12H 1250 high-bright display module.

**Table 28 - Adapter Plates**

Cat. No.	Adapts This PanelView Plus 6 Terminal	To This Terminal Cutout
2711P-RAK4	400 keypad or keypad/touch 600 touch	PanelView Standard 550 keypad
2711P-RAK6	600 keypad or keypad/touch	PanelView Standard 600 keypad
2711P-RAK7	700 keypad or keypad/touch	PanelView Standard 900 keypad
2711P-RAT7	700 touch	PanelView Standard 900 touch
2711P-RAK10	1000 keypad or keypad/touch	PanelView 1000/1000e keypad
2711P-RAT10	1000 touch	PanelView 1000/1000e touch
2711P-RAK15	1500 keypad or keypad/touch	PanelView 1200e/1400e keypad
2711P-RAT15	1500 touch	PanelView 1200e/1400e touch
2711P-RAK12E	1250 keypad <sup>(1)</sup>	PanelView 1200/1400e keypad
2711P-RAT12E2	1250 touch <sup>(2)</sup>	PanelView 1200 touch
2711P-RAT12E	1250 touch <sup>(2)</sup>	PanelView 1200e/1400e touch
2711P-RAK12S	1250 keypad <sup>(1)</sup> or keypad/touch	PanelView Standard 1400 keypad
2711P-RAT12S	1250 touch <sup>(2)</sup>	PanelView Standard 1400 touch

(1) Applies also to PanelView 1000/1000e keypad or keypad/touch terminals.

(2) Applies also to PanelView 1000/1000e touch terminals.

## Install Terminal

Topic	Page
Required Circuit Parameters for USB Peripheral Devices	27
Mounting Clearances	28
Panel Guidelines	28
Panel Cutout Dimensions	28
Remove and Install the Power Terminal Block	35
Mount the 400/600 Terminal in a Panel	31
Mount the 700 to 1500 Terminal in a Panel	33
Remove and Install the Power Terminal Block	35
DC Power Connections	36
AC Power Connections	39
Initial Startup	41
Reset the Terminal	41



### ATTENTION: Environment and Enclosure

This equipment is intended for use in a Pollution Degree 2 industrial environment, in overvoltage Category II applications (as defined in IEC 60664-1), at altitudes up to 2000 m (6561 ft) without derating.

The terminals are intended for use with programmable logic controllers. Terminals that are AC powered must be connected to the secondary of an isolating transformer.

This equipment is considered Group 1, Class A industrial equipment according to IEC CISPR 11. Without appropriate precautions, there may be difficulties with electromagnetic compatibility in residential and other environments due to conducted or radiated disturbances.

Korean Radio Wave Suitability Registration - When so marked this equipment is registered for Electromagnetic Conformity Registration as business equipment (A), not home equipment. Sellers or users are required to take caution in this regard.



This equipment is supplied as open-type equipment. It must be mounted within an enclosure that is suitably designed for those specific environmental conditions that will be present and appropriately designed to prevent personal injury resulting from accessibility to live parts. The interior of the enclosure must be accessible only by the use of a tool. The terminals meet specified NEMA, UL type, and IEC ratings only when mounted in a panel or enclosure with the equivalent rating. Subsequent sections of this publication may contain additional information regarding specific enclosure type ratings that are required to comply with certain product safety certifications.

In addition to this publication, see the following:

- Industrial Automation Wiring and Grounding Guidelines, publication [1770-4.1](#), for additional installation requirements
- NEMA Standards 250 and IEC 60529, as applicable, for explanations of the degrees of protection provided by different types of enclosure



**North American Hazardous Location Approval**

The following information applies when operating this equipment in hazardous locations.	Informations sur l'utilisation de cet équipement en environnements dangereux.
<p>When marked, these products are suitable for use in "Class I, Division 2, Groups A, B, C, D"; Class I, Zone 2, Group IIC, Class II, Division II, Groups F, G; Class III hazardous locations and nonhazardous locations only. Each product is supplied with markings on the rating nameplate indicating the hazardous location temperature code. When combining products within a system, the most adverse temperature code (lowest "T" number) may be used to help determine the overall temperature code of the system. Combinations of equipment in your system are subject to investigation by the local Authority Having Jurisdiction at the time of installation.</p>	<p>Lorsqu'ils sont marqués, ces produits ne conviennent qu'à une utilisation en environnements Classe I, Division 2, Groupes A, B, C et D ; Classe I, Zone 2, Groupe IIC, Classe II, Division II, Groupes F et G ; Classe III, dangereux ou non dangereux. Chaque produit est livré avec des marquages sur sa plaque d'identification qui indiquent le code de température pour les environnements dangereux. Lorsque plusieurs produits sont combinés dans un système, le code de température le plus défavorable (code " T " le plus faible) peut être utilisé pour déterminer le code de température global du système. Les combinaisons d'équipements dans le système sont sujettes à inspection par les autorités locales qualifiées au moment de l'installation.</p>
<div style="display: flex; align-items: center;">  <div> <p><b>WARNING: EXPLOSION HAZARD</b></p> <ul style="list-style-type: none"> <li>Do not disconnect equipment unless power has been removed or the area is known to be nonhazardous.</li> <li>Do not disconnect connections to this equipment unless power has been removed or the area is known to be nonhazardous.</li> <li>Substitution of components may impair suitability for Class I, Division 2.</li> <li>Peripheral equipment must be suitable for the location in which it is used.</li> <li>The battery or real-time clock module in this product must only be changed in an area known to be nonhazardous.</li> <li>All wiring must be in accordance with Class I, Division 2, Class II, Division 2, or Class III, Division 2 wiring methods of Articles 501, 502 or 503, as appropriate, of the National Electrical Code and/or in accordance with Section 18-1J2 of the Canadian Electrical Code, and in accordance with the authority having jurisdiction.</li> </ul> </div> </div>	<div style="display: flex; align-items: center;">  <div> <p><b>AVERTISSEMENT : RISQUE D'EXPLOSION</b></p> <ul style="list-style-type: none"> <li>Couper le courant ou s'assurer que l'environnement est classé non dangereux avant de débrancher l'équipement.</li> <li>Couper le courant ou s'assurer que l'environnement est classé non dangereux avant de débrancher les connecteurs.</li> <li>La substitution de composants peut rendre cet équipement inadapté à une utilisation en environnement de Classe I, Division 2</li> <li>Les équipements périphériques doivent s'adapter à l'environnement dans lequel ils sont utilisés.</li> <li>La batterie ou le module de l'horloge en temps réel de ce produit doit être changé(e) uniquement dans un environnement classé sans risque.</li> <li>Tous les systèmes de câblage doivent être de Classe I, Division 2, Classe II, Division 2, ou Classe III, Division 2, conformément aux méthodes de câblage indiquées dans les Articles 501, 502 ou 503 du National Electrical Code (Code Electrique National) et/ou conformément à la Section 18-1J2 du Canadian Electrical Code (Code Electrique Canadien), et en fonction de l'autorité de juridiction.</li> </ul> </div> </div>

**Table 29 - Temperature Codes - PanelView Plus 6 Terminals**

Terminal Model	Input Power	Temperature Code	Description
400 and 600 terminals	DC	T4	Do not install terminals rated T4 in environments where atmospheric gases have ignition temperatures less than 135 °C (275 °F).
	AC	T4	
700 to 1500 terminals	DC	T4	Do not install terminals rated T3 in environments where atmospheric gases have ignition temperatures less than 200 °C (392 °F).
	AC	T3	

## Required Circuit Parameters for USB Peripheral Devices

The terminals contain one or two USB host ports that comply with hazardous location environments. Field-wiring compliance requirements are provided in compliance with the National Electrical Code, Article 500.

**Figure 4 - PanelView Plus 6 Terminals Control Drawing**

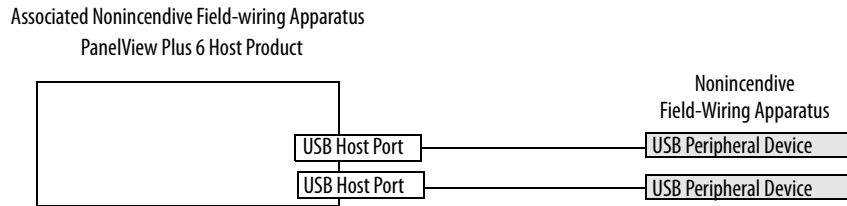

PanelView™ Plus 6 terminals provide one or two separately-powered USB host ports. [Table 30](#) defines the circuit parameters of the USB host ports.

**Table 30 - Circuit Parameters for USB Host Ports**

Parameter	Value	Parameter Definition	
$V_{oc(USB)}$	5.25V DC	Open circuit voltage of the host USB port. The maximum applied voltage rating, $V_{max(Peripheral)}$ , of the USB peripheral device must be greater than or equal to $V_{oc(USB)}$ .	$V_{max(Peripheral)} \geq V_{oc(USB)}$ , as appropriate
$I_{sc(USB)}$	1.68 A	Maximum output current of the host USB port. The maximum current, $I_{max(Peripheral)}$ , to which each USB peripheral device can be subjected must be greater than or equal to $I_{sc(USB)}$ .	$I_{max(Peripheral)} \geq I_{sc(USB)}$
$C_{a(USB)}$	10 $\mu$ F	This value is the maximum total capacitance that can be connected to the USB host port. The total capacitance of the USB peripheral device and its associated cable must not exceed the indicated value. The maximum total capacitance, $C_{i(Peripheral)}$ , and cable capacitance of the separate USB peripheral device must be less than or equal to $C_{a(USB)}$ .	$C_{i(Peripheral)} + C_{cable(USB)} \leq C_{a(USB)}$
$L_{a(USB)}$	15 $\mu$ H	This value is the maximum total inductance that can be connected to the USB host port. The total inductance of the USB peripheral device and its associated cable must not exceed the indicated value. The maximum total inductance, $L_{i(Peripheral)}$ , and cable inductance of the separate USB peripheral device must be less than or equal to $L_{a(USB)}$ .	$L_{i(Peripheral)} + L_{cable} \leq L_{a(USB)}$

### Application Information

Per the National Electrical Code, the circuit parameters of associated field-wiring apparatus for use in hazardous locations must be coordinated with the host product such that their combination remains nonincendive. PanelView Plus 6 terminals and the USB peripheral devices must be treated in this manner.

The USB peripheral devices and their associated cabling must have circuit parameters with the limits given in [Table 30](#) for them to remain nonincendive when used with the PanelView Plus 6 USB host port.

If cable capacitance and inductance are not known, use the following values from ANSI/ISA-RP 12.06.01-2003:

$$C_{cable} = 197 \text{ pF/m (60 pF/ft)}$$

$$L_{cable} = 0.7 \text{ } \mu\text{H/m (0.20 } \mu\text{H/ft)}$$

Nonincendive field-wiring must be wired and separated in accordance with 501.10(B)(3) of the National Electrical Code (NEC) ANSI/NFPA 70 or other local codes as applicable. This associated nonincendive field-wiring apparatus has not been evaluated for use in combination with another associated nonincendive field-wiring apparatus.

## Mounting Clearances

Plan for adequate space around the terminal, inside the enclosure, for ventilation and connections. Consider heat produced by other devices in the enclosure. The ambient temperature around the terminal must be 0...55 °C (32...131 °F).

**Table 31 - Minimum Required Clearances**

Product Area	Minimum Clearance
Top	51 mm (2 in.)
Bottom	102 mm (4 in.)
Side	25 mm (1 in.)
Back	0 mm (0 in.)

A clearance of 102 mm (4 in.) is sufficient on the side of the terminal to insert and remove an SD card, and on the bottom of terminal for connections.

## Panel Guidelines

The terminals are panel-mounted devices intended to mount in the door or wall of a NEMA rated, UL Type rated, or IP rated enclosure:

- Supporting panels must have a mounting thickness of 1.5...4.8 mm (0.060...0.188 in.).
- The material strength and stiffness of the panel must be sufficient to hold the terminal and maintain an appropriate seal against water and dust.
- The panel surface must be flat and free of imperfections to maintain an adequate seal and NEMA and UL Type ratings.

## Panel Cutout Dimensions

Use the full size template shipped with your terminal to mark the panel cutout dimensions.

**Table 32 - Panel Cutout Dimensions**

Terminal	Input Type	Height, mm (in.)	Width, mm (in.)
400	Keypad or keypad/touch	123 (4.86)	156 (6.15)
600	Keypad or keypad/touch	142 (5.61)	241 (9.50)
	Touch	123 (4.86)	156 (6.15)
700	Keypad or keypad/touch	167 (6.57)	264 (10.39)
	Touch	154 (6.08)	220 (8.67)
1000	Keypad or keypad/touch	224 (8.8)	375 (14.75)
	Touch	224 (8.8)	305 (12.00)
1250	Keypad or keypad/touch	257 (10.11)	390 (15.35)
	Touch <sup>(1)</sup>	257 (10.11)	338 (13.29)
1500	Keypad or keypad/touch	305 (12.00)	419 (16.50)
	Touch	305 (12.00)	391 (15.40)

(1) Also applies to high-bright display module, cat. no. 2711P-RDT12H.

## Product Dimensions

Table 33 and Table 34 provide product dimensions for all PanelView Plus 6 terminals.

Figure 5 - PanelView Plus 6 - 400 Keypad or Keypad/Touch

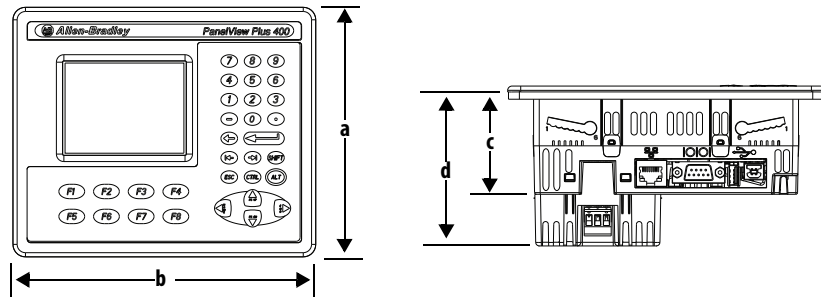

Figure 6 - PanelView Plus 6 - 600 Touch

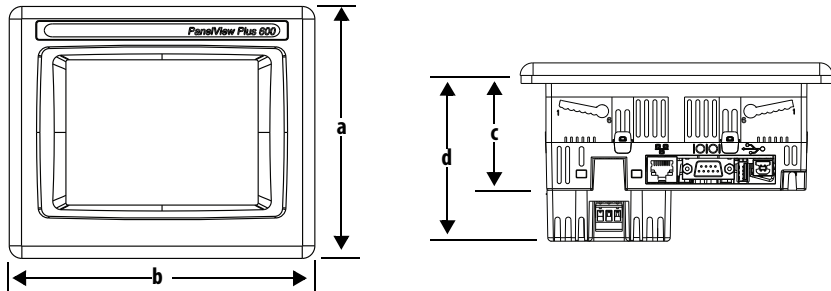

Figure 7 - PanelView Plus 6 - 600 Keypad or Keypad/Touch

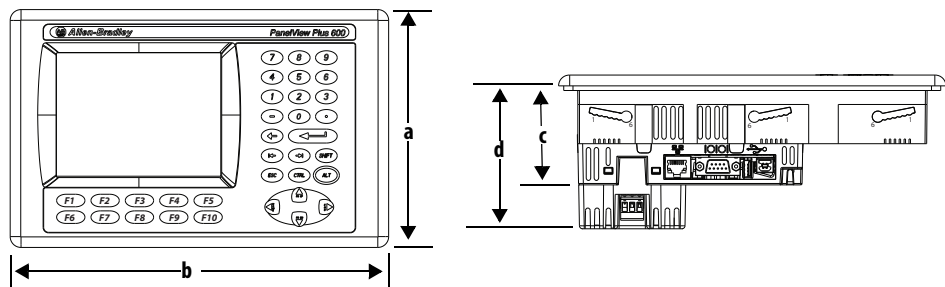

Table 33 - PanelView Plus 6 - 400 and 600 Product Dimensions

Terminal	Input Type	Height (a) mm (in.)	Width (b) mm (in.)	Depth (c) mm (in.)	Depth (d) with AC module mm (in.)
400	Keypad or keypad/touch	152 (6.0)	185 (7.28)	60 (2.35)	90 (3.54)
600	Keypad or keypad/touch	167 (6.58)	266 (10.47)	68 (2.68)	98 (3.86)
	Touch	152 (6.0)	185 (7.28)	68 (2.68)	98 (3.86)

The 700 to 1500 terminals look similar. The 1000 keypad and keypad/touch terminals are shown for illustrative purposes.

Figure 8 - PanelView Plus 6 - 1000 Keypad, Keypad/Touch, Touch

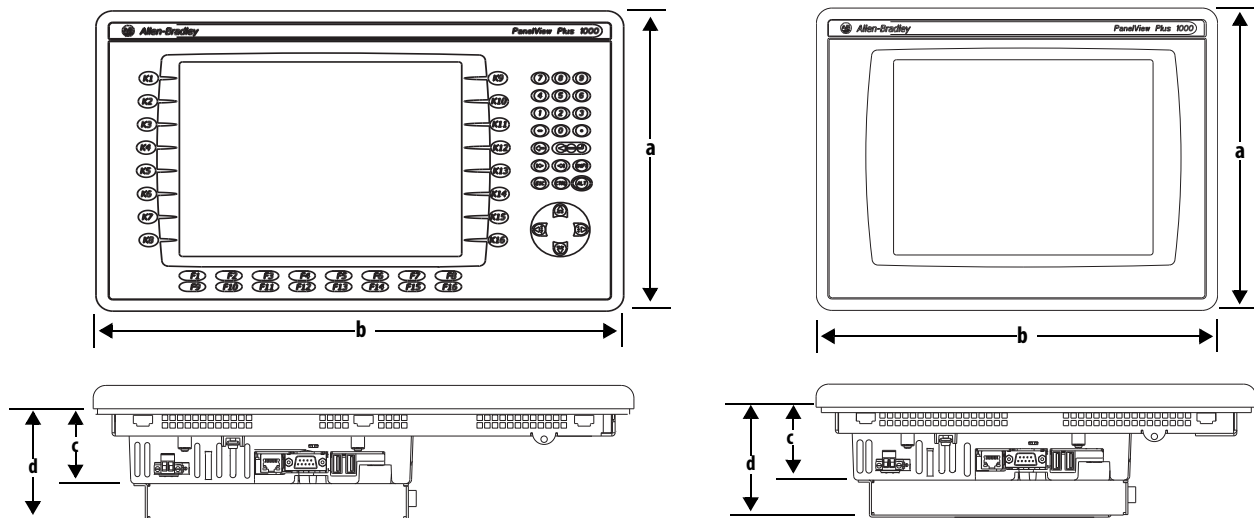

Table 34 - PanelView Plus 6 - 700 to 1500 Terminal Dimensions

Terminal	Input Type	Height (a) mm (in.)	Width (b) mm (in.)	Depth (c) Display to Logic Module mm (in.)	Depth (d) Display to Comm Module mm (in.)
700	Keypad or keypad/touch	193 (7.58)	290 (11.40)	55 (2.18)	83 (3.27)
	Touch	179 (7.04)	246 (9.68)	55 (2.18)	83 (3.27)
1000	Keypad or keypad/touch	248 (9.77)	399 (15.72)	55 (2.18)	83 (3.27)
	Touch	248 (9.77)	329 (12.97)	55 (2.18)	83 (3.27)
1250	Keypad or keypad/touch	282 (11.12)	416 (16.36)	55 (2.18)	83 (3.27)
	Touch	282 (11.12)	363 (14.30)	55 (2.18)	83 (3.27)
	Touch (high-bright module)	282 (11.12)	363 (14.30)	74 (2.9)	101 (3.99)
1500	Keypad or keypad/touch	330 (12.97)	469 (18.46)	65 (2.55)	93 (3.65)
	Touch	330 (12.97)	416 (16.37)	65 (2.55)	93 (3.65)

## Mount the 400/600 Terminal in a Panel

The terminals were designed for single-person installation. No tools are required except for those needed to make the panel cutout

Mounting levers secure the terminal to the panel. Four or six levers are required depending on the terminal model. The levers insert into the mounting slots on the top and bottom of the terminal.

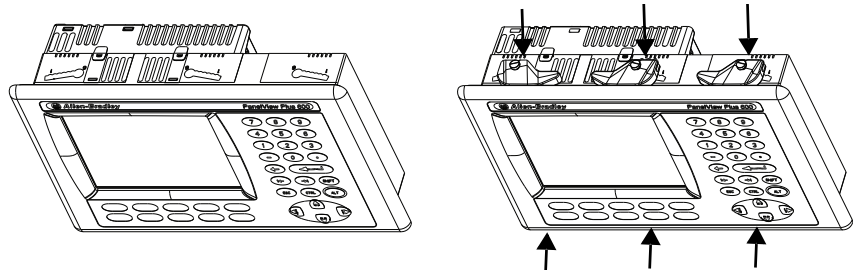

Each mounting slot has six notches with alignment marks that are locking positions for a lever. The thickness of the panel in which you mount the terminal determines the locking position required to maintain the NEMA/UL Type seal.

**Table 35 - Lever Locking Positions**

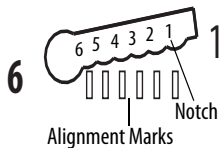
Mounting Slot	Lever Lock Position	Panel Thickness Range	Typical Gauge
Orientation of Slot Varies  	1	1.50...2.01 mm (0.060...0.079 in.)	16
	2	2.03...2.64 mm (0.080...0.104 in.)	14
	3	2.67...3.15 mm (0.105...0.124 in.)	12
	4	3.17...3.66 mm (0.125...0.144 in.)	10
	5	3.68...4.16 mm (0.145...0.164 in.)	8/9
	6	4.19...4.80 mm (0.165...0.188 in.)	7

Follows these steps to mount the terminal in a panel.



**ATTENTION:**

Disconnect all electrical power from the panel before making the panel cutout. Make sure the area around the panel cutout is clear and that the panel is clean of any debris, oil, or other chemicals. Make sure metal cuttings do not enter any components already installed in the panel and that the edges of the cutout have no burrs or sharp edges. Failure to follow these warnings can result in personal injury or damage to panel components.

1. Cut an opening in the panel by using the cutout template shipped with the terminal or the cutout dimensions on [page 28](#).
2. Verify the sealing gasket is present on the terminal.

This gasket forms a compression type seal. Do not use sealing compounds.

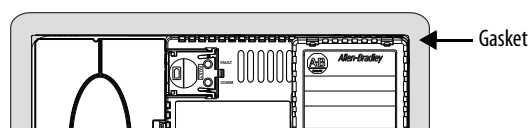

- Place the terminal in the panel cutout.

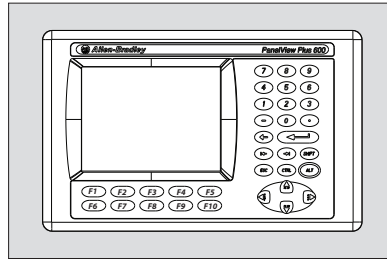

- Insert all mounting levers into the mounting slots on the terminal.  
Slide each lever until the flat side of the lever touches the panel surface.

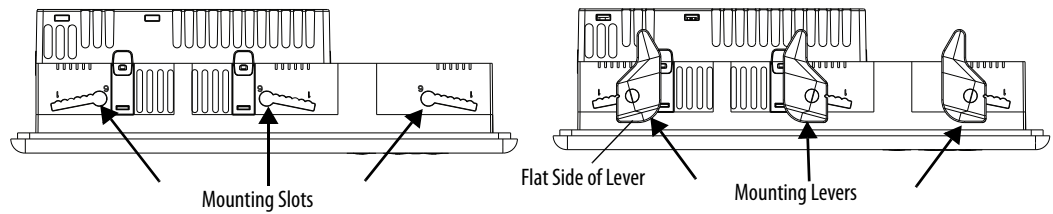

- When all levers are in place, slide each lever an additional notch or two until you hear a click.  
Refer to [Table 35 on page 31](#) as a guide to determine the locking positions for your panel thickness.
- Rotate each lever in direction indicated until it is in the final position.

**TIP** Levers rotate in same direction on top and bottom of terminal.

Follow the appropriate locking sequence for the optimal terminal fit.

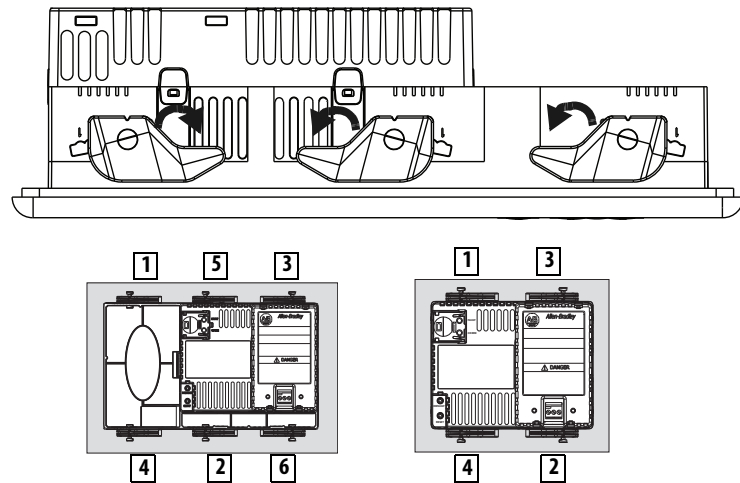
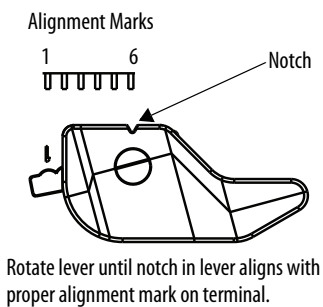

- Inspect all levers to verify they are in the correct and same locked position.



**ATTENTION:** All levers must be locked to provide an adequate gasket seal between the terminal and the panel. Rockwell Automation assumes no responsibility for water or chemical damage to the terminal or other equipment within the enclosure because of improper installation.



## Mount the 700 to 1500 Terminal in a Panel

Mounting clips secure the 700 to 1500 terminals in a panel. The number of clips varies by terminal size. Tools required for installation include panel cutout tools, a small, slotted screwdriver, and a torque wrench for tightening the mounting clips.



### ATTENTION:

Disconnect all electrical power from the panel before making the panel cutout. Make sure the area around the panel cutout is clear and that the panel is clean of any debris, oil, or other chemicals.

Make sure metal cuttings do not enter any components already installed in the panel and that the edges of the cutout have no burrs or sharp edges.

Failure to follow these warnings can result in personal injury or damage to panel components.

---

**IMPORTANT** For outdoor installations using a high-bright display module, catalog number 2711P-RDT12H, refer to Appendix B on [page 177](#) for important installation considerations.

---

Follow these steps to mount the terminal in a panel.

1. Cut an opening in the panel by using the panel cutout template shipped with the terminal or the cutout dimensions on [page 28](#).
2. Verify the terminal sealing gasket is properly positioned on the terminal.  
This gasket forms a compression type seal. Do not use sealing compounds.

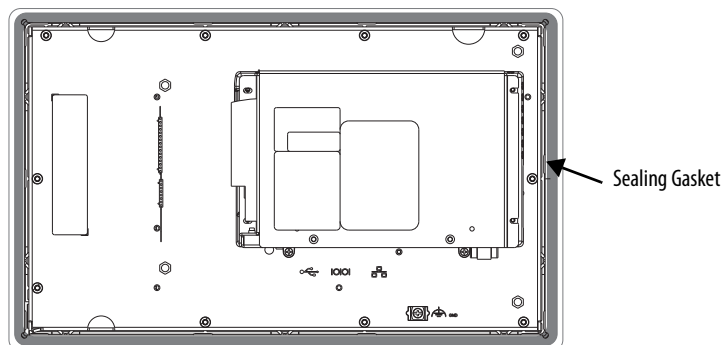

Be careful not to pinch the legend strip during installation.

- Place the terminal in the panel cutout.

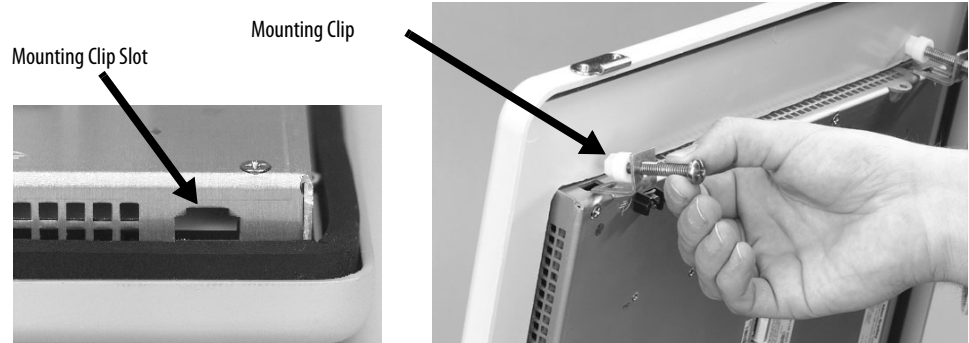

- Slide the ends of the mounting clips into the slots on the terminal.
- Tighten the mounting clip screws by hand until the gasket seal contacts the mounting surface uniformly.



- Tighten the mounting clips screws to a torque of 0.90...1.1 N•m (8...10 lb•in) by using the specified sequence, making sure not to overtighten.

1	4
Torque Sequence 4 Clips	
3	2

1	5	3
Torque Sequence 6 Clips		
4	2	6

1	6
Torque Sequence 8 Clips	
3	8
7	4
5	2



**ATTENTION:** Tighten the mounting clips to the specified torque to provide a proper seal and to prevent damage to the product. Allen-Bradley assumes no responsibility for water or chemical damage to the product or other equipment within the enclosure because of improper installation. Any contamination of the product caused by improper installation is not warranted.

## Remove and Install the Power Terminal Block

The terminals are shipped with a power terminal block installed. You can remove the terminal block for ease of installation, wiring, and maintenance.



### WARNING: Explosion Hazard

If you connect or disconnect wiring while the power is on, an electrical arc can occur. This could cause an explosion in hazardous location installations. Be sure that power is removed and the area is nonhazardous before proceeding.

Failure to remove power can result in electrical shock or damage to the terminal.

The terminal blocks have different colors and markings for AC and DC power connections. Always match the terminal block color to its mating connector. The power terminal blocks are not intended for daisy chaining power.

Use a 0.6 x 3.5 mm flat blade screwdriver for terminal block wiring.

**Table 36 - Wire Specifications for Power Input Terminal Block**

Terminal	Wire Type	Dual-wire Size <sup>(1)</sup>	Single-wire Size	Strip Length	Screw Torque
400, 600	Stranded or solid Cu 90 °C (194 °F)	0.3...1.3 mm <sup>2</sup> 22...16 AWG	0.3...2.1 mm <sup>2</sup> (22...14 AWG)	7 mm (0.28 in.)	0.45...0.56 N•m (4...5 lb•in)
700 to 1500					0.56...0.90 N•m (5...8 lb•in)

(1) Two-wire max per terminal.

### 400 and 600 Terminals

Follow these steps to remove the terminal block from a 400 or 600 terminal.

1. Insert the tip of a small, flat-blade screwdriver into the terminal block access slot.
2. Gently pry the terminal block to rotate it away from the terminal; this releases the locking mechanism.

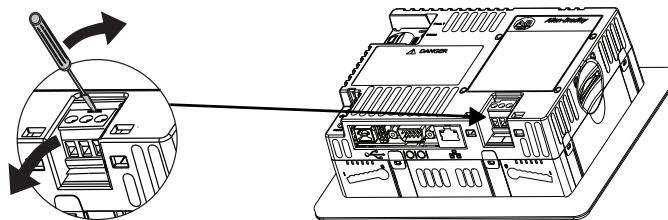

Follow these steps to replace the terminal block.

1. Press terminal block base in first with block leaning outward.

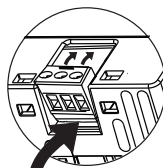

2. Gently push the top of the terminal block to rotate it into place; it snaps when seated.

## 700 to 1500 Terminals

Follow these steps to remove the terminal block from a 700 to 1500 terminal.

1. Loosen the two screws that secure the terminal block.
2. Gently pull the terminal block away from the connector.

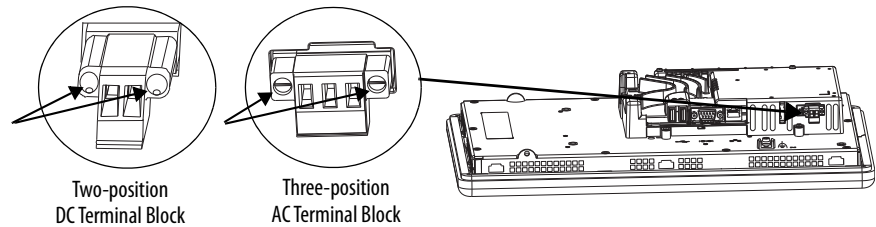

Follow these steps to install the terminal block.

1. Reattach the terminal block to the connector until seated.
2. Tighten the two screws that secure the terminal block to a torque of 0.40...0.51 N•m (3.5...4.5 lb•in).

## DC Power Connections

Terminals with an integrated 24V DC power supply have these power ratings.

**Table 37 - DC Power Ratings**

Terminal	Power Supply	Input Voltage	Power Consumption
400, 600	Nonisolated	24V DC nom (18...30V DC)	15 W max (0.6 A at 24V DC)
700 to 1500	Isolated	24V DC nom (18...32V DC)	70 W max (2.9 A at 24V DC)

The power supply is internally protected against reverse polarity. Connecting DC+ or DC- to the earth/ground terminal can damage the device.



**ATTENTION:** Applying an AC power source to a terminal with a DC power input can damage the device.



**ATTENTION:** Proper Input Voltage must be applied at all times. Voltage Spikes or power quality issues that cause the voltage to go outside of the proper input range may cause damage to the device; this condition is not warranted by Rockwell Automation.

## External Power Supply

The 400 and 600 terminals require a dedicated 24V DC Class 2 power supply or a safety extra-low voltage (SELV) or protective extra-low voltage (PELV) power supply to power each PanelView Plus 6 400 and 600 device.

For the 700 - 1500 terminals, it is recommended that a dedicated 24V DC safety extra-low voltage (SELV) or protective extra-low voltage (PELV) power supply is used to power each PanelView Plus 6 700 - 1500 device.



**ATTENTION:** Use a SELV or PELV power supply as required by local wiring codes for your installation. These power supplies provide protection so that under normal and single fault conditions, the voltage between conductors and earth ground does not exceed a safe value.

**TIP** Terminals with an isolated DC power supply can be powered by the same power source as other equipment, such as a DC power bus.

PanelView Plus 6 devices were tested to operate with the catalog number 1606-XLE120E power supply. To use another power supply, review the criteria in the table.

**Table 38 - Power Supply Criteria**

If the PanelView Plus 6 Device	Use a	Description
Connects to equipment with isolated communication ports	SELV or PELV power supply	Other equipment can share this power supply with the PanelView Plus 6 device provided that no ground loops are created. A PELV source internally connects the negative power terminal to chassis ground.
Does not connect to other equipment		
Connects to equipment with non-isolated communication ports	Dedicated, isolated, and ungrounded SELV source to power each terminal	This prevents ground loops from damaging the device.

**IMPORTANT** All of the communication ports on the terminals and supported communication modules are isolated, with the exception of the USB ports.

## Earth/Ground Connection



PanelView Plus 6 devices with a DC power input have an earth/ground terminal that you must connect to a low-impedance earth/ground.

- On 400 and 600 terminals, the earth/ground connection is on the power terminal block.
- On 700 to 1500 terminals, the earth/ground connection is on the rear of the display module.

**IMPORTANT** The earth/ground connection to ground is mandatory. This connection is required for the following:

- Noise immunity, reliability, and Electromagnetic Compliance (EMC) with the European Union (EU) EMC directive for CE-mark conformance
- Safety by Underwriters Laboratory

**Table 39 - Earth Wire Specifications for DC Power**

Terminal	Symbol	Wire Type	Wire Gauge	Terminal Screw Torque
400, 600	 GND	Stranded or solid Cu 90 °C (194 °F)	2.1...3.3 mm <sup>2</sup> (14...12 AWG)	0.45...0.56 N·m (4...5 lb·in)
700 to 1500	 GND	Stranded or solid Cu 90 °C (194 °F)	2.1...5.3 mm <sup>2</sup> (14...10 AWG)	1.13...1.36 N·m (10...12 lb·in)



**ATTENTION:** Damage or malfunction can occur when a voltage potential exists between two separate ground points. Make sure the terminal does not serve as a conductive path between ground points at different potentials.

### Connect DC Power



**WARNING:** Explosion Hazard  
Do not disconnect equipment unless power has been switched off and area is known to be nonhazardous.  
Disconnect all power before installing or replacing components. Failure to disconnect power can result in electrical shock or damage to the terminal.

Follow these steps to connect the terminal to DC power.

1. Verify that the terminal is not connected to a power source.
2. Strip 7 mm (0.28 in.) of insulation from the ends of the wires.

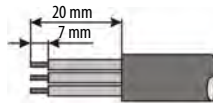

3. Secure the DC power wires to the marked terminals (+ and -) on the power terminal block.
4. Secure the earth/ground wire.
  - On 400 and 600 terminals, secure the earth/ground wire to the functional earth/ground terminal on the power terminal block.
  - On 700 to 1500 terminals, secure the earth/ground wire to the functional earth screw on the back of the display.

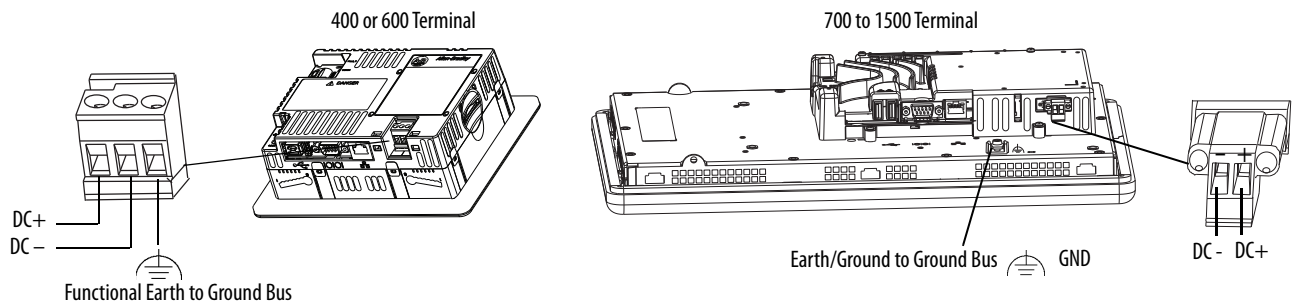

5. Apply power to the terminal.

## AC Power Connections

Terminals with an integrated AC power supply have these power ratings.

**Table 40 - AC Power Ratings**

Terminal	Input Voltage	Power Consumption
400, 600	100...240V AC (50...60 Hz)	35VA max
700, 1000, 1250, 1500	100...240V AC (50...60 Hz)	160VA max

## Protective Earth and Functional Earth Connections

PanelView Plus 6 devices with an AC power input have a protective earth terminal you must connect to a low-impedance earth ground. The protective earth terminal is on the power input terminal block.

**IMPORTANT** In addition to the protective earth connection, the 700 and 1500 terminals also have a functional earth terminal that you must connect to a low-impedance earth ground. The functional earth connection is on the back of the display.



**ATTENTION:** The protective earth and functional earth connections to ground are mandatory.

- The functional earth is required for Electromagnetic compliance (EMC) with the European Union (EU) EMC directive for CE-mark conformance.
- The protective earth is required for both safety and regulatory compliance.

**Table 41 - Protective Earth/Functional Earth Wire Specifications for AC Power**

Earth Connections		Wire Type		Wire Gauge	Terminal Screw Torque
Protective earth 400, 600		Stranded or solid	Cu 90 °C (194 °F)	2.1...3.3 mm <sup>2</sup> (14...12 AWG)	0.45...0.56 N·m (4...5 lb·in)
Protective earth 700 to 1500		Stranded or solid	Cu 90 °C (194 °F)	2.1...3.3 mm <sup>2</sup> (14...12 AWG)	0.56...0.90 N·m (5...8 lb·in)
Functional earth 700 to 1500 only	GND	Stranded or solid	Cu 90 °C (194 °F)	2.1...5.3 mm <sup>2</sup> (14...10 AWG)	1.13...1.36 N·m (10...12 lb·in)

## Connect AC Power



**WARNING:** Explosion Hazard

Do not disconnect equipment unless power has been switched off and area is known to be nonhazardous.

Disconnect all power before installing or replacing components. Failure to disconnect power can result in electrical shock or damage to the terminal.



**ATTENTION:** Improper wiring of the power terminals can result in voltage at the communication connector shells.

Do not apply power to the terminal until all wiring is connected. Failure to do so can result in electrical shock.

Follow these steps to connect the terminal to AC power.

1. Verify that the terminal is not connected to a power source.
2. Strip 7 mm (0.28 in.) of insulation from the ends of the wires.

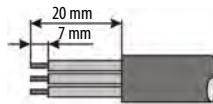

3. Secure the AC power wires to the marked terminals (L1 and L2N) on the power terminal block.
4. Secure the protective earth/ground wire to the marked position on the power terminal block.
5. On 700 to 1500 terminals, also secure the functional earth/ground wire to the functional earth screw on the back of display to ground bus.

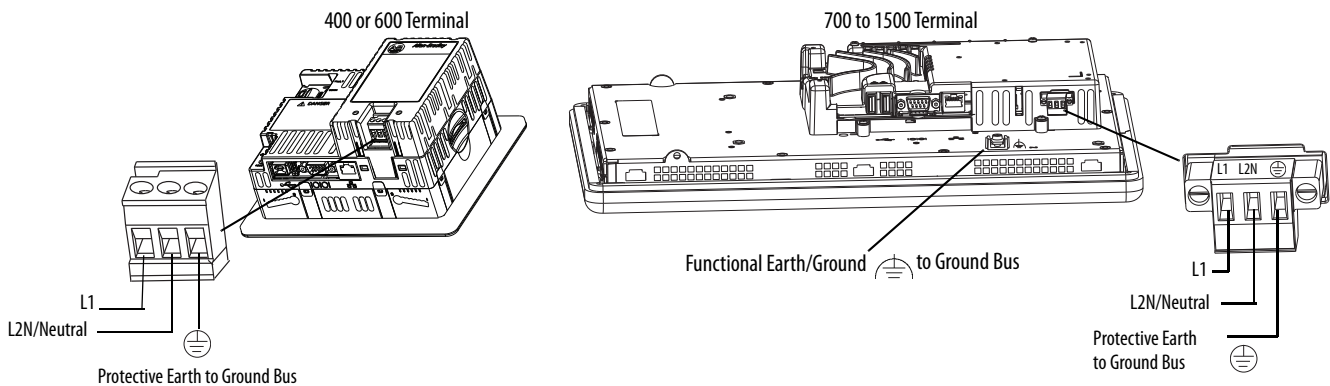

6. Apply power to the terminal.



## Initial Startup

The first time you start the system, the terminal goes through its power-up sequence and launches FactoryTalk® View ME Station Configuration mode.

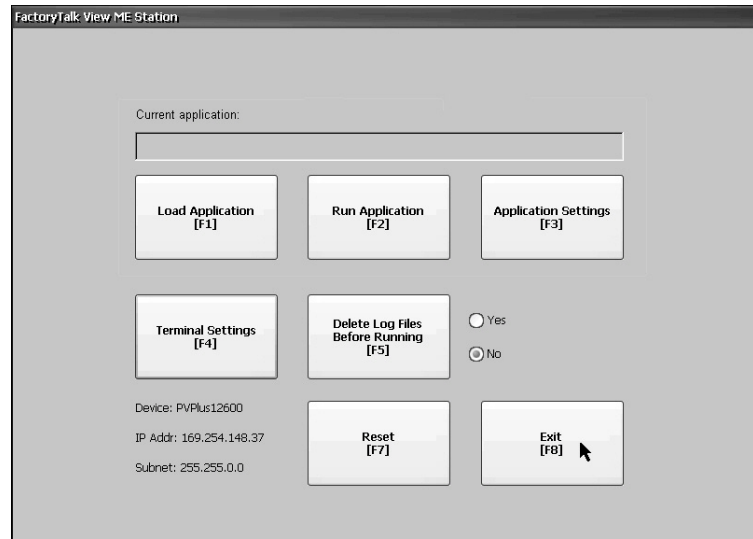

You can change the action the terminal takes on startup by pressing Terminal Settings then choosing Startup Options. You can configure one of these options:

- Launch a FactoryTalk Machine Edition HMI application that is configured to run at startup.
- Launch FactoryTalk View Machine Station Configuration mode and run the configuration options for the terminal (default).
- Launch the Windows Explorer desktop.

You can also configure a terminal to allow desktop access. Terminals are initially shipped with desktop access disabled. To allow or restrict desktop access, press Terminal Settings then choose Desktop Access.

For more information on changing the start-up option and restricting or allowing desktop access, refer to [Chapter 3 - Configuration Mode](#).

## Reset the Terminal

You have several options for restarting the terminal without having to disconnect and reapply power:

- Use the Reset switch on the back of the terminal.
- From the terminal desktop Start menu, choose Restart System.
- On the FactoryTalk View ME Station configuration dialog box, press Reset.

After a restart, the terminal performs a series of start-up tests then takes one of these actions:

- Launches an HMI application that is configured to run at startup.
- Launches FactoryTalk Machine Edition Configuration mode.
- Launches the Windows Explorer desktop.

The action that occurs depends on the start-up options configured for your terminal. Refer to [Start-up Options on page 49](#) for details.

Refer to [Start-up Messages and Codes on page 164](#) for a list of start-up information and error messages.

Follow these steps to restart the system by using the Reset switch.

1. Insert a thin, nonconductive probe into the Reset area.
2. Press the switch.



**ATTENTION:** Use a nonconductive object to press the reset switch. Don't use a conducting object such as a paper clip or the tip of a pencil. Either of these can damage the terminal.

**Figure 9 - Reset Switch**

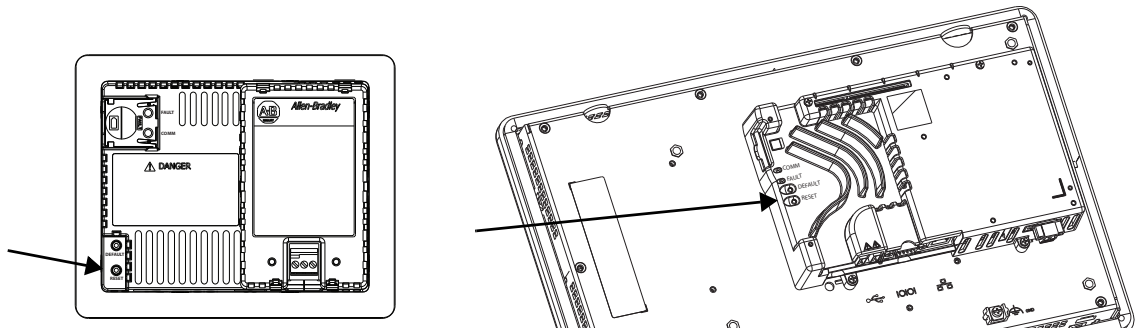

Follow these steps to restart the system from the Windows desktop.

1. From the Start menu, choose Programs>Restart System.  
You are asked to confirm the restart.
2. Click Yes to restart the terminal or No to cancel.

Follow these steps to restart the system from FactoryTalk View ME Station software.

1. Access Configuration Mode.  
Refer to [Access Configuration Mode on page 43](#) for ways to launch FactoryTalk View ME Station Configuration mode.
2. Press Reset [F7].

## Configuration Mode

Topic	Page	Topic	Page
Access Configuration Mode	43	Configure Print Options	70
Terminal Settings	46	Check Integrity of Application Files	72
Load and Run Application	48	Configure Diagnostics	73
Start-up Options	49	View and Clear the System Event Log	74
Desktop Access	52	System Information	74
Communication Setup	56	Enable or Disable the Alarm Display	76
Ethernet Network Connections	58	Time and Date Settings	77
File Management	62	Regional Settings	79
Display Settings	65	Font Linking	82
Input Device Settings	67		

### Access Configuration Mode

The terminal uses built-in software, FactoryTalk® View ME Station, to configure start-up options, load and run applications, access the Windows desktop, and perform other terminal operations. When you reset the terminal, one of these actions occurs, depending on the configured start-up option:

- FactoryTalk View ME Station Configuration mode is launched (closed system). This is the initial default.
- FactoryTalk View Machine Edition HMI .mer application is set to run (closed system).
- Windows Explorer desktop is launched (open system).



You can access the Configuration mode of the terminal from the Windows Explorer desktop by double-clicking the FactoryTalk View ME Station icon.

#### IMPORTANT

- To access Configuration mode from a running application, press Goto Configuration Mode. This button is added to application screens in FactoryTalk View Studio software during application development. The application stops running but is still loaded.
- Refer to [Configuration Mode Access on page 168](#) for details on how to access Configuration mode if the application does not contain a Goto Configuration Mode button.

Figure 10 - FactoryTalk View ME Station Configuration Mode Dialog Box

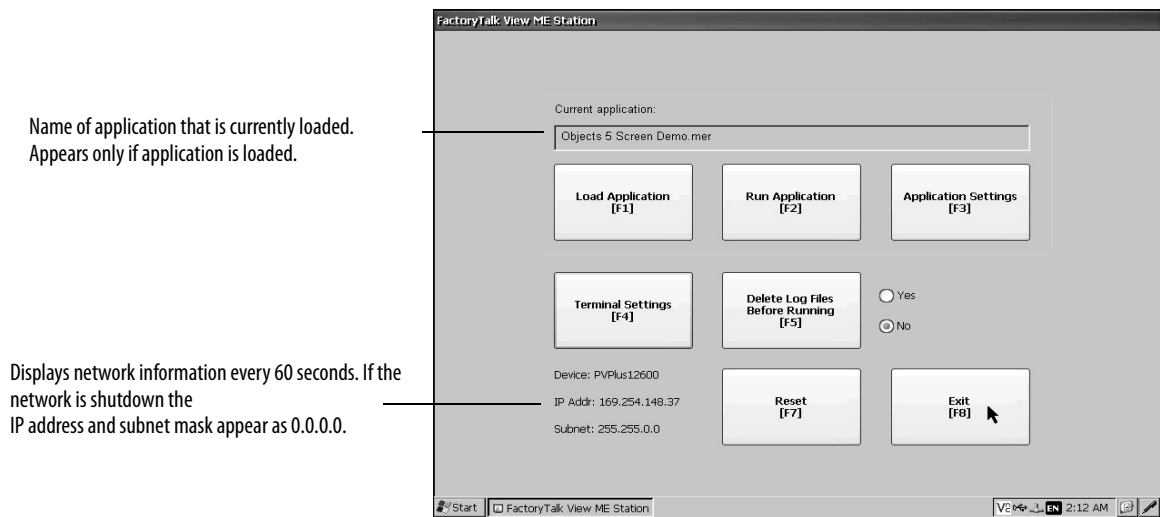

Name of application that is currently loaded. Appears only if application is loaded.

Displays network information every 60 seconds. If the network is shutdown the IP address and subnet mask appear as 0.0.0.0.

Table 42 - Configuration Mode Operations







Terminal Operation	Description
Load Application (F1)	Opens a dialog box where you select an application to load. The loaded application name appears under Current application.
Run Application (F2)	Runs the loaded .mer application displayed under Current application. You must load an application before running it.
Application Settings (F3)	Opens a menu of application-specific configuration settings, such as device shortcuts defined for the loaded .mer application. Device shortcuts are read-only and cannot be edited. For example, your .MER application can have CLX defined as a device shortcut name for a ControlLogix® controller.
Terminal Settings (F4)	Opens a menu of options to configure non-application, terminal settings for the PanelView™ Plus 6 device.
Delete Log Files Before Running (F5)	Toggles between Yes and No. If you select Yes, all data log files, alarm history and alarm status file are deleted before the application is run. If you select No, log files are not deleted first. Deleting log files is a way to reclaim memory in the terminal.
Reset (F7)	Resets the terminal, then launches the HMI application, configuration mode, or the desktop depending on the configured start-up option.
Exit (F8)	Exits Configuration mode. If desktop access is allowed, you can access the desktop.

### Navigation Buttons

Many FactoryTalk View ME Station dialog boxes have data entry and navigation buttons:

- On touch-screen terminals, press the button with your finger or stylus.
- On keypad terminals, press the function key listed on the button.
- If a mouse is attached, click a button.

Table 43 - Navigation Buttons

Button	Description	Button	Description
	Returns to the previous dialog box. Pressing this button from the Configuration mode dialog box accesses the desktop, if allowed.	 	Moves highlight up or down a list.
 	Accepts changes and returns to previous dialog box or cancels the operation without saving changes.		Selects a highlighted function or item from a list.

## Input Panel

When you activate a data entry field, the input panel opens. If the field is restricted to a numeric value or IP address, then only the 0...9 and decimal point keys are enabled.

**Figure 11 - Input Panel**

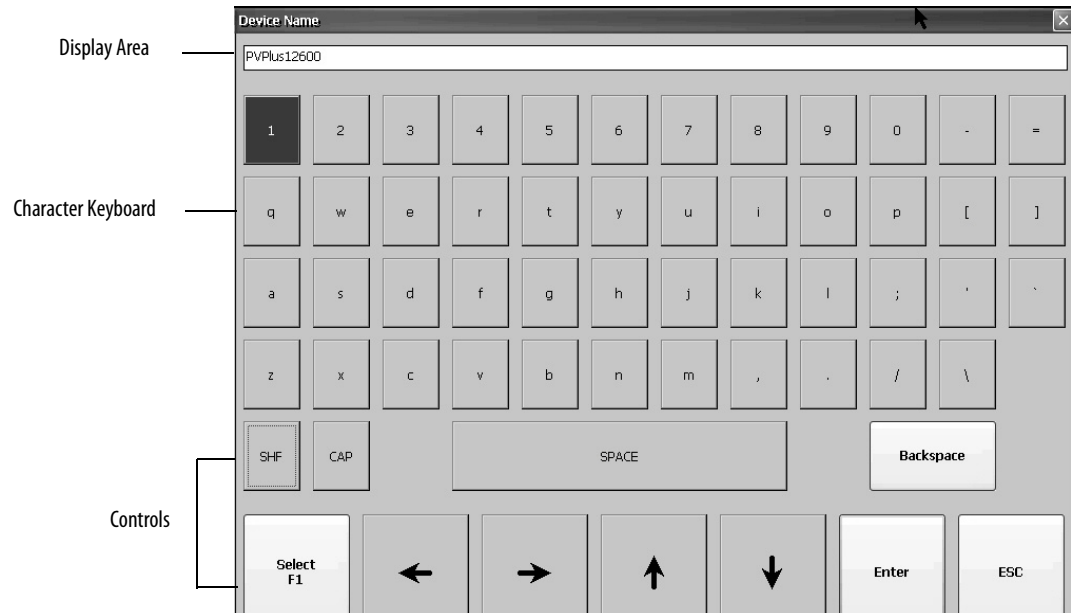

**Table 44 - Input Panel Controls**

Input Panel Controls	Function
SHF	Switches keys between their shifted and unshifted state. The initial default is unshifted.
CAP	Switches keys between lowercase and uppercase characters. The initial default is lowercase.
SPACE	Enters a space between characters in the Display Area.
Backspace	Deletes the previous character (to the left of the cursor) in the Display Area.
Select	Selects a character and enters it in the Display Area.
Left, Right, Up, Down Arrow Keys	Selects the character to the left, right, above, or below the currently selected character.
Enter	Accepts the entered characters and returns to the previous dialog box.
ESC	Cancels the current operation and returns to the previous dialog box.

Follow these steps to enter characters in the display area.

1. Select a character on the character keyboard:
  - On a touch-screen terminal, press a key.
  - On a keypad terminal, press the arrow keys on the keypad to navigate to a key.
  - If a mouse is attached, click a key.
2. Press Select to copy the character to the display area.
3. Press Enter when done to exit the input panel.

## Terminal Settings

You can modify settings on the terminal that are not specific to the application.

1. Press Terminal Settings from the FactoryTalk View ME Station Configuration mode dialog box.

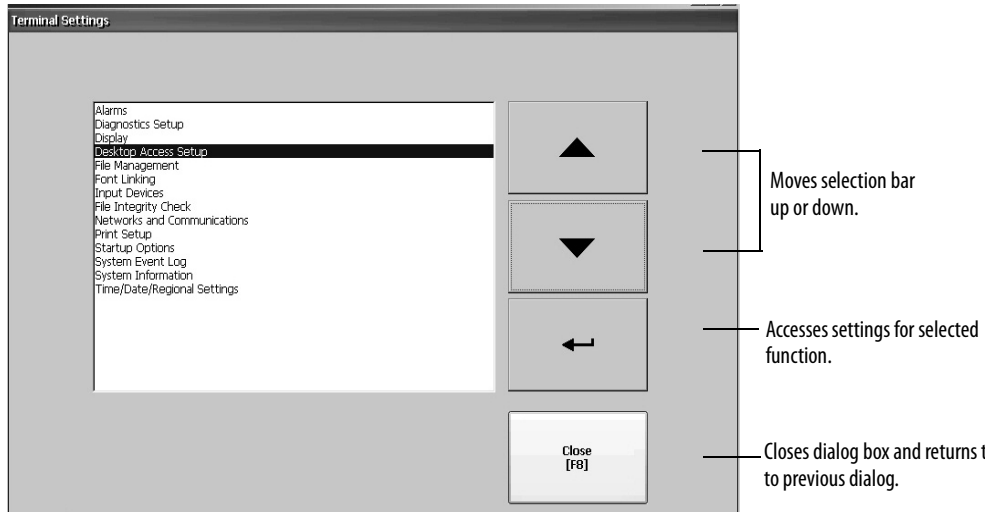

2. Select a function by using the up and down cursor buttons:
  - On touch-screen terminals, press the button.
  - On keypad terminals, press the key on the keypad or the corresponding terminal function key.
3. Press the Enter key to access selected function.

**Table 45 - Terminal Settings**

Terminal Settings	Description
Alarms	Specifies whether to close the alarm display on the terminal when the newest alarm is acknowledged by an operator. By default, the alarm display is closed.
Diagnostics Setup	Forwards diagnostic messages from a remote log destination to a computer running diagnostics.
Display	Sets the intensity of the backlight, shows the temperature of the 700 to 1500 displays, configures the screen saver, and enables the touch-screen cursor.
Desktop Access Setup	Specifies whether the desktop can be accessed with or without a password, and lets you set/reset the password.
File Management	Copies application files and font files to the terminal, an SD card or a USB flash drive. You can also delete application files from the terminal, an SD card or USB drive. Log files generated by the application can be deleted from the terminal.
Font Linking	Links a font file to a base font loaded on the terminal.
Input Devices	Configures settings for the keypad, touch screen, or attached keyboard and mouse, including touch-screen calibration. Also lets you choose between a pop-up character input or pop-up keyboard for string input.
File Integrity Check	Checks the integrity of the .mer application file and runtime files by logging details to a file integrity check log. You can view and clear this log at any time.
Networks and Communications	Configures Ethernet or other communication settings for applications.
Print Setup	Configures settings for printing displays, alarm messages, and diagnostics messages generated by the application.
Startup Options	Specifies whether the terminal launches the desktop, Configuration mode, or runs an application on startup.
System Event Log	Displays system events logged by the terminal and lets you clear events from the log.
System Information	Displays power, temperature, battery and memory details for the terminal. Also shows the firmware number for FactoryTalk View ME software and technical support information.
Time/Date/Regional Settings	Sets the date, time, language, and numeric format used by the terminal and applications.

**Figure 12 - Terminal Settings Menu Structure**

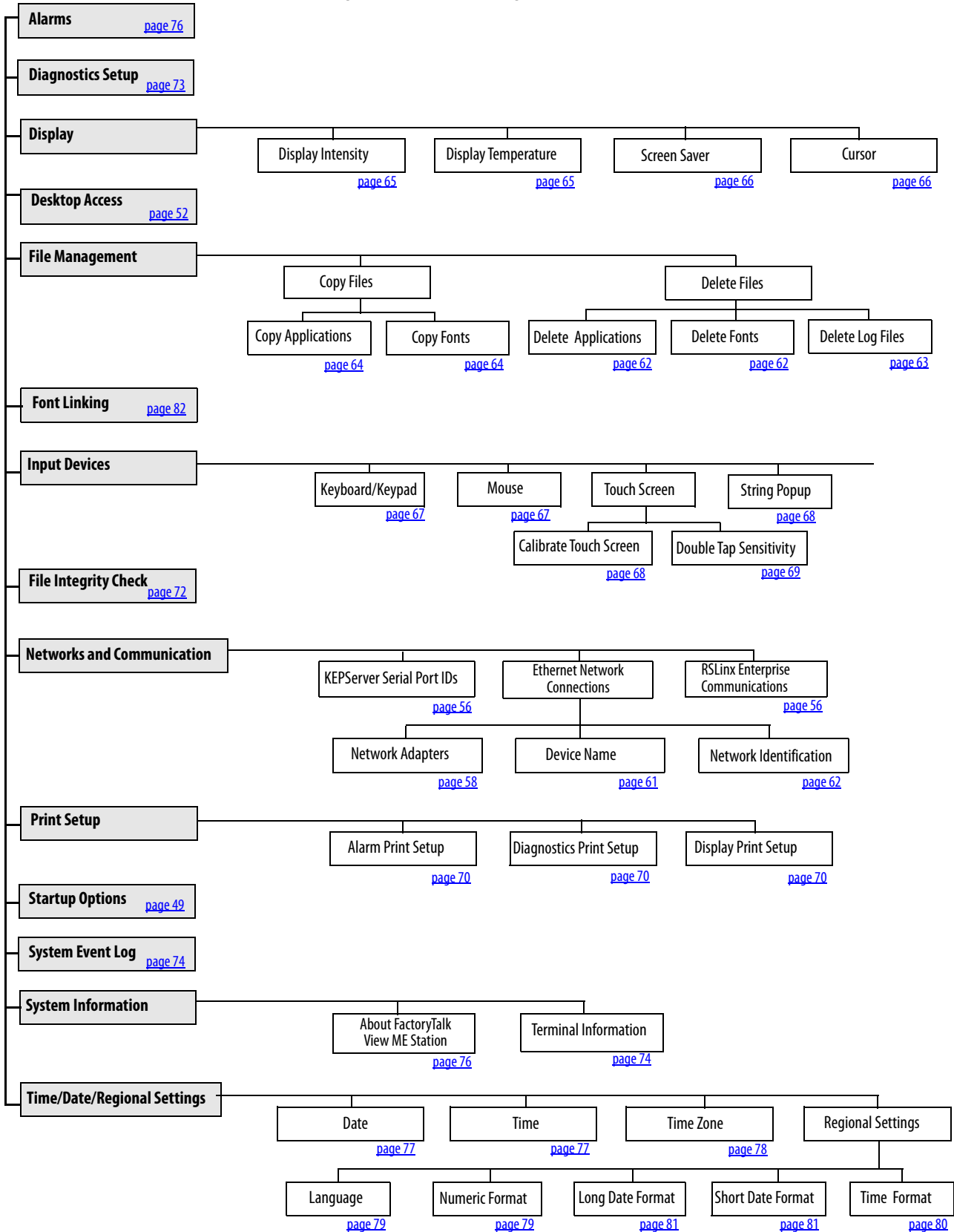

## Load and Run Application

Before running a FactoryTalk View Machine Edition .mer application, you must first load the application. You can load an .mer application from internal storage or nonvolatile memory in the terminal, an SD card, or a USB flash drive.

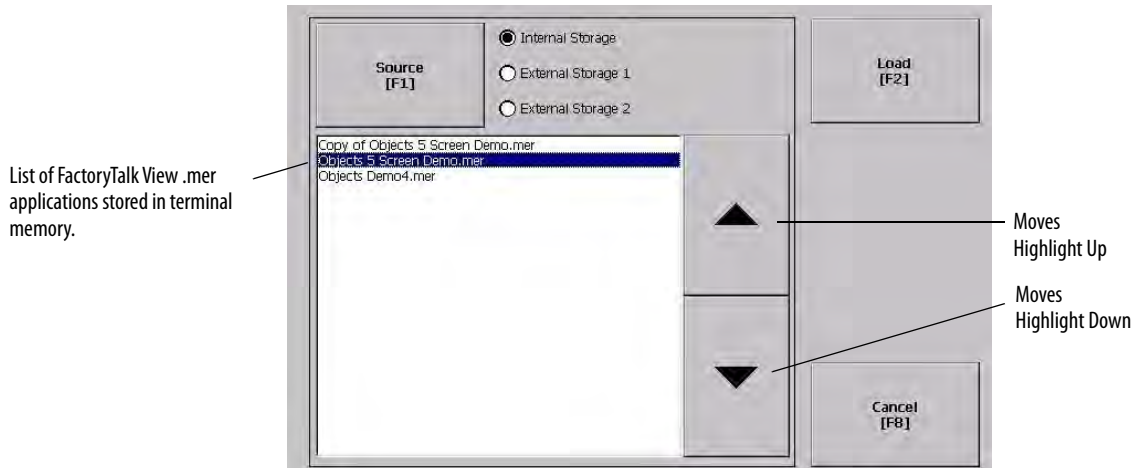

Follow these steps to load and run an application.

1. Press Load Application from the Configuration mode dialog box.
2. Press Source to select the location of the file you want to load:
  - Internal Storage - nonvolatile memory of the terminal.
  - External Storage 1 - SD card loaded in the card slot of the terminal.
  - External Storage 2 - USB flash drive connected to a USB host port.

**TIP** The recognized path for Machine Edition files on the terminal, USB flash drive, or SD card is \Application Data\Rockwell Software\RSViewME\Runtime\. On the terminal, the path is in My Device on the desktop.

3. Select an .mer file from the list by using the up and down cursor keys.
4. Press Load to load the selected application.

You are asked if you want to replace the terminal's communication configuration with the configuration in the application.

5. Select Yes or No.

If you select Yes, any changes to the device addresses or driver properties in the RSLinx® Communications dialog box are lost.

The name of the currently loaded application appears at the top of the main Configuration mode dialog box.

6. Press Run on the Configuration mode dialog box to run the loaded application.

**TIP** Applications generate log files. To delete log files before running an application, select Delete Log Files Before Running on the Configuration Mode dialog box. Deleting log files reclaims terminal memory.

**TIP** [Refer to Start-up Options on page 49](#) to set the application to automatically run on startup or a terminal reset.



## Start-up Options

You can specify what action the terminal takes on startup or a reset.

This Start-up Option	Performs This Action	Typical System
Do not start FactoryTalk View ME Station	Launches the Windows Explorer desktop on startup.	Open
Go to Configuration Mode	Launches FactoryTalk View ME Station Configuration mode on startup. This is the initial, factory default setting.	Closed
Run Current Application	Runs the FactoryTalk View ME application loaded in the terminal on startup.	Closed

**IMPORTANT** When desktop access is restricted, the start-up option must be set to Run Current Application or Go to Configuration Mode (default). Refer to [page 52](#) for details on how to enable or disable desktop access.

### Disable FactoryTalk View ME Station Software on Startup

Terminals with extended features and file viewers are typically configured to launch the Windows desktop on startup. This means you must disable FactoryTalk View ME Station from launching on startup.

**TIP** The desktop can also be launched from FactoryTalk View ME Station Configuration mode by pressing Exit.

Follow these steps to disable FactoryTalk View ME Station on startup so that the desktop can launch.

1. Press Terminal Settings>Startup Options.

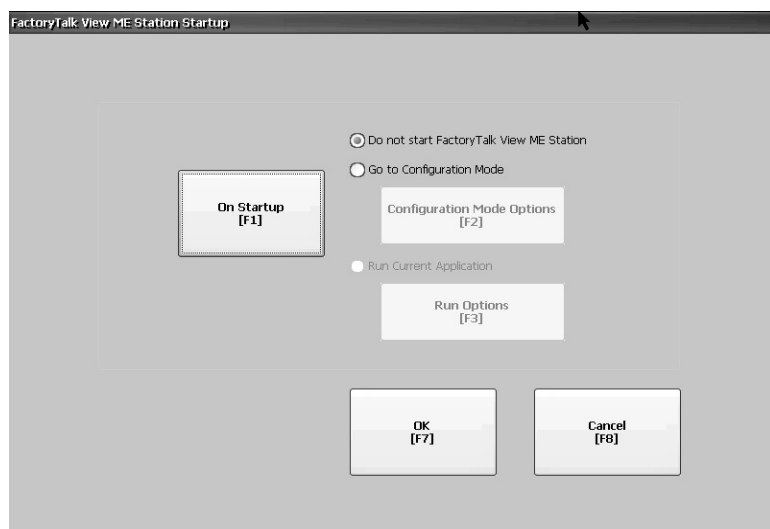

2. Press On Startup until 'Do not start FactoryTalk View ME Station' is selected.

**TIP** When disabling FactoryTalk View ME Station, desktop access must be set to allow or you get a warning. Refer to [Enable Desktop Access on page 52](#).

3. Press OK.

## Enter Configuration Mode on Startup

Follow these steps to automatically launch the FactoryTalk View ME Station Configuration mode dialog box on startup.

1. Press Terminal Settings>Startup Options.
2. Press On Startup to select Go to Configuration Mode.

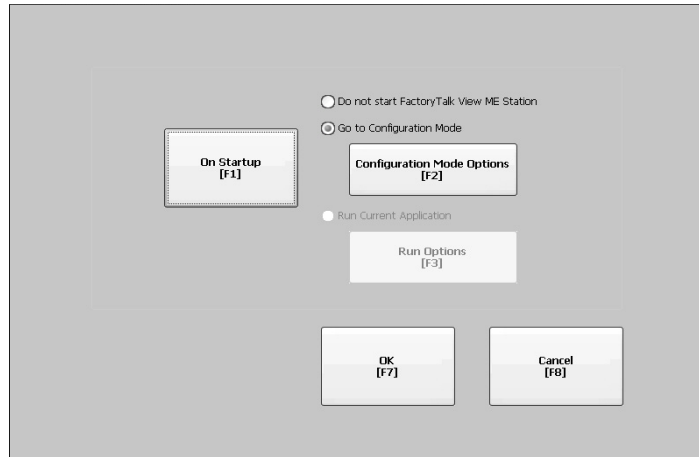

3. Press Configuration Mode Options.

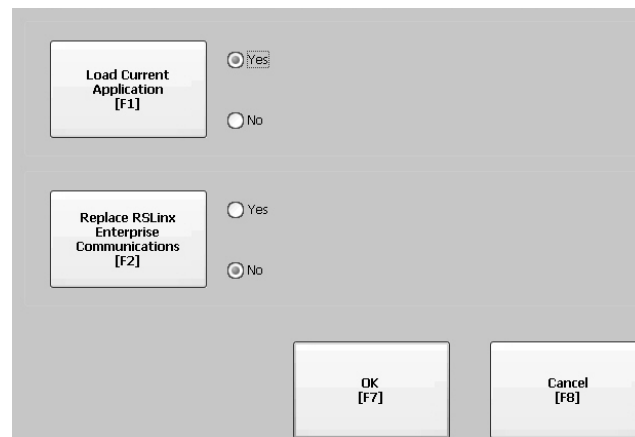

4. Press Load Current Application to specify whether you want to load the current application on startup.
5. Press Replace RSLinx Enterprise Communications to specify whether to use the communication configuration of the current application or that of the terminal on startup:
  - Select No to use the RSLinx configuration of the terminal.
  - Select Yes to use the configuration of the application. The terminal configuration is replaced with the application settings. Any changes to device addresses or driver properties in RSLinx communication are lost.
6. Press OK to return to the previous dialog box.
7. Press OK to return to Terminal Settings.

## Run the Loaded Application on Startup

Follow these steps to run the FactoryTalk View .mer application currently loaded in the terminal on startup. This is typical when running a closed system.

1. Press Terminal Settings>Startup Options.

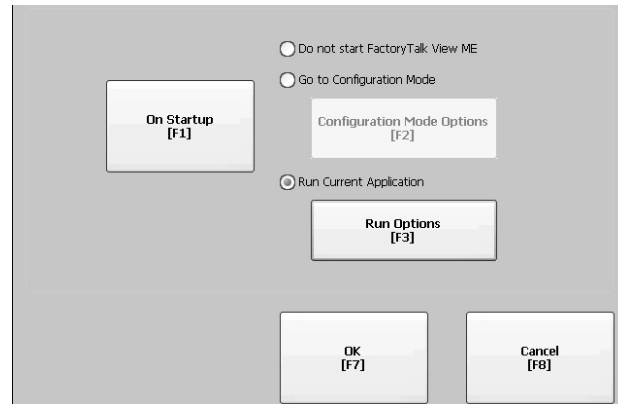

2. Press On Startup to select Run Current Application.

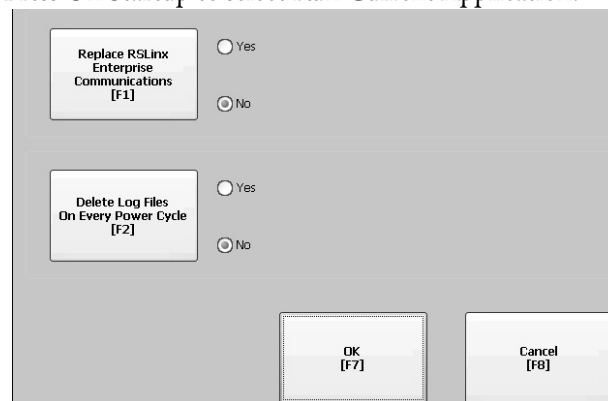

If an application is not loaded, the options are disabled.

3. Press Replace RSLinx Enterprise Communications to specify what configuration settings to use when running the application:
  - Select No to use the RSLinx configuration of the terminal.
  - Select Yes to use the configuration of the application. The terminal configuration is replaced with the application settings. Any changes to device addresses or driver properties in RSLinx communication are lost.
4. Press Delete Log Files On Every Power Cycle to specify what action to take with the log files on startup:
  - Select Yes to delete all log files (data, alarm history, alarm status) generated by the terminal before running application. The files are deleted from the system default location.
  - Select No to retain all log files.
5. Press OK twice to return to Terminal Settings.

## Desktop Access

You can allow or restrict access to the Windows desktop on all terminals. From the desktop, you can perform system and control panel operations, or run third-party applications. Terminals with extended features can additionally run viewers, media players, and launch the web browser. You can allow access temporarily to perform specific tasks, then disable desktop access to prevent unauthorized changes.

Typically, a terminal does not allow desktop access unless it has extended features.

**TIP** All terminals are shipped from factory with desktop access disabled.

With restricted access, the only way to access the desktop is to first enter a password. The terminals are shipped from the factory with a default password and challenge question that we recommend you change:

- Default password = password (case sensitive)
- Default challenge question = What is the opposite of lock?
- Default challenge answer = unlock (case sensitive)

When desktop access is set to allow, you can access the desktop by pressing Exit from FactoryTalk View ME Station Configuration mode.

### Enable Desktop Access

Follow these steps to enable desktop access.

1. Press Terminal Settings>Desktop Access Setup.
2. Press Desktop Access to select Allow.

The Enter Password dialog box appears.

**TIP** Each time you change access from disallow to allow, you are required to enter a password. The initial default password is 'password'.

3. Press Password to enter the password and press Enter.
4. Press Enter again to return to Desktop Access Management.

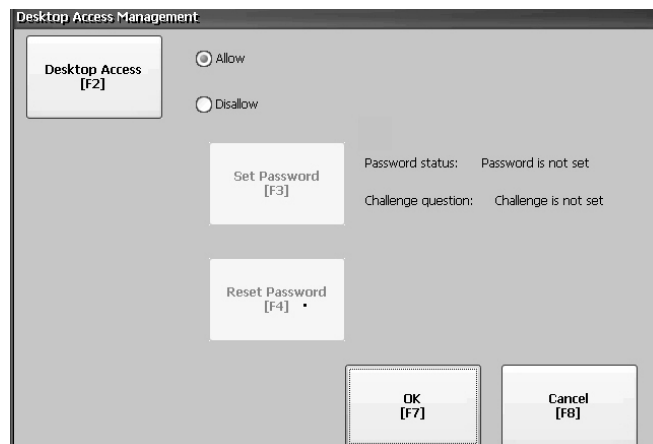

Notice that the password has been cleared.

5. Press OK to exit Desktop Access Management, then Close to exit Terminal Settings.
6. Press Exit from FactoryTalk View ME Station Configuration mode to access the desktop.

With desktop access set to allow, you are not required to enter a password.

## Disable Desktop Access

To restrict desktop access, the FactoryTalk View ME Station start-up option must be set to one of these options:

- Go to Configuration Mode (this is the default)
- Run Current Application

See [page 49](#) for details on how to change the start-up option.

You also are required to enter a password and challenge question:

- The password is required to access the desktop from FactoryTalk View ME Station Configuration mode when pressing Exit.
- The challenge question and response are required to change the password with the Reset Password function.

Follow these steps to disable desktop access.

1. Press Terminal Settings>Desktop Access Setup.
2. Press Desktop Access to select Disallow.

The Set Password button is enabled.

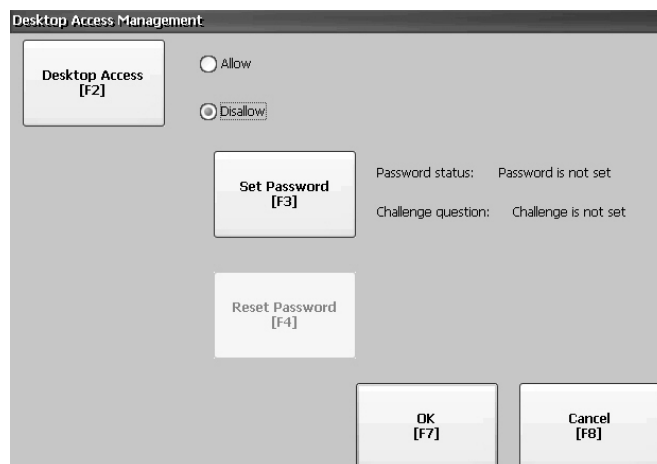

**TIP** If the start-up option was not set to Run Current Application or Go to Configuration mode, you get an error.

3. Refer to [Set a Desktop Password on page 54](#) to set a password and challenge question.

You must set a password and challenge question when disabling desktop access or you get an error message.

## Set a Desktop Password

---

**IMPORTANT** If you disallow or restrict access to the desktop, you are required to set a password along with a challenge question.

---

Follow these steps to set a new password.

1. Press Set Password from Desktop Access Management.

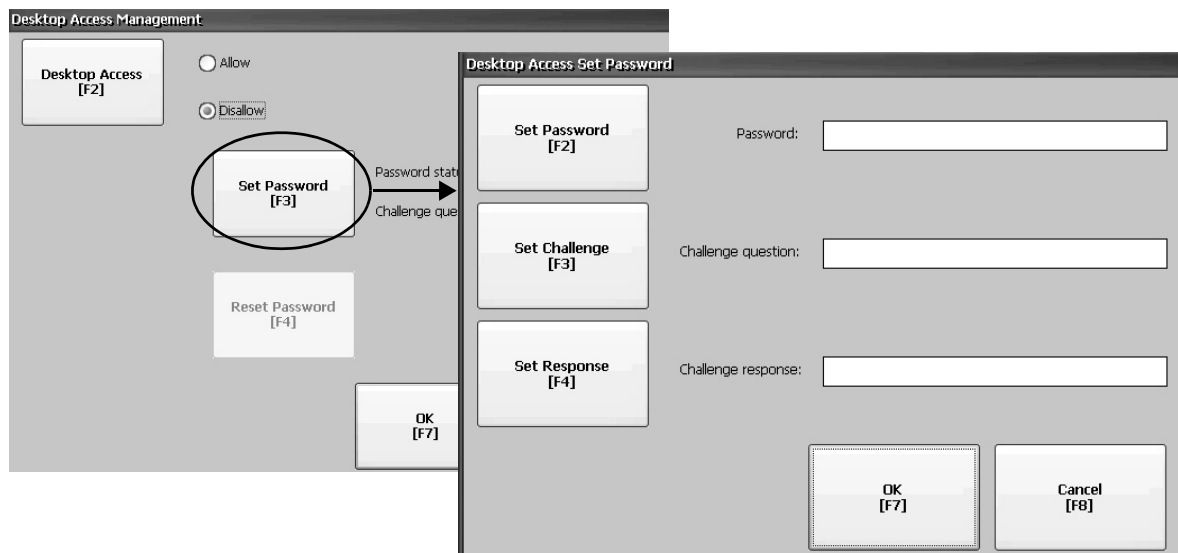

2. Press Set Password and enter an 8...20 character password, then press Enter.

**TIP** You must correctly enter this password before accessing the desktop.

3. Press Set Challenge and enter a question that you must correctly respond to before changing the password with the Reset Password button.
4. Press Set Response to enter the response to the challenge question, then press Enter.
5. Press OK.

The Desktop Access Management dialog box shows that a password and challenge question are set.

6. Press OK to return to Terminal Settings.

---

**IMPORTANT** Secure your password and challenge question for future use. To clear and reset the password, you must correctly respond to the challenge question. If you forget the response, the only way to clear the password is to restore the factory default settings on the terminal. Refer to [Access Maintenance Operations on page 170](#) for details on how to restore factory defaults.

---

## Reset the Desktop Password

To clear the current password and reset a new password, you must first correctly respond to the current challenge question. If you cannot remember the response, you have to restore the terminal to its factory default settings. Refer to [Access Maintenance Operations on page 170](#).

---

**IMPORTANT** You can clear and reset the password and challenge question if access to the desktop is restricted or set to disallow.

---

Follow these steps to reset a desktop access password.

1. Press Reset Password from Desktop Access Management.

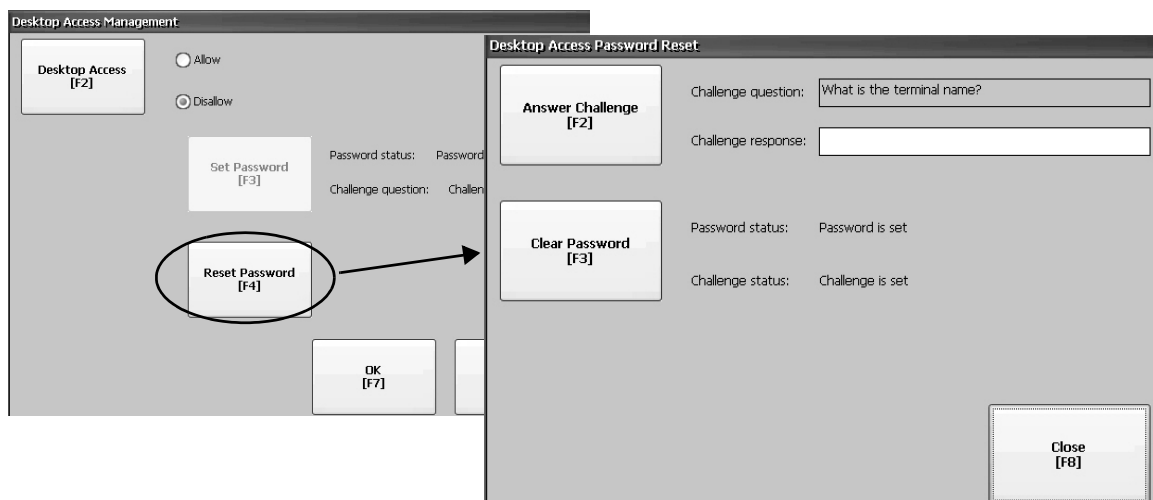

2. Press Answer Challenge and enter the correct response to the current challenge question.
3. Press Clear Password to clear the current password and challenge question.

The status of the password and challenge information is updated.

Password status: Password is not set  
 Challenge status: Challenge is not set

4. Press Close.
5. Follow the [Set a Desktop Password](#) procedure on [page 54](#) to set a new password and challenge question.

After the password is cleared, you must set a new desktop password or change the desktop access to allow.

## Communication Setup

You configure communication for your application and controller by using RSLinx Enterprise software:

- Access KEPServer Serial Port IDs.
- Edit the driver settings for the protocol used by your .mer application.
- Edit the device address of the controller on the network.

### Configure KEPServer Serial Port IDs

To access KEPServer serial communication, you must have KEPServer Enterprise installed on your terminal. If you plan on using KEPServer Enterprise and serial communication, you must specify the COM port to use.

To access the KEPServer Serial Port ID dialog box, press Terminal Settings>Networks then Communications>KEPServer Serial Port IDs. If KEPServer Enterprise is not installed, you get an error message.

### Configure RSLinx Communication Properties

Follow these steps to configure driver settings for the communication protocol used by your application.

1. Press Terminal Settings>Networks then Communications>RSLinx Enterprise Communications.

You see a tree view of installed cards and network configurations.

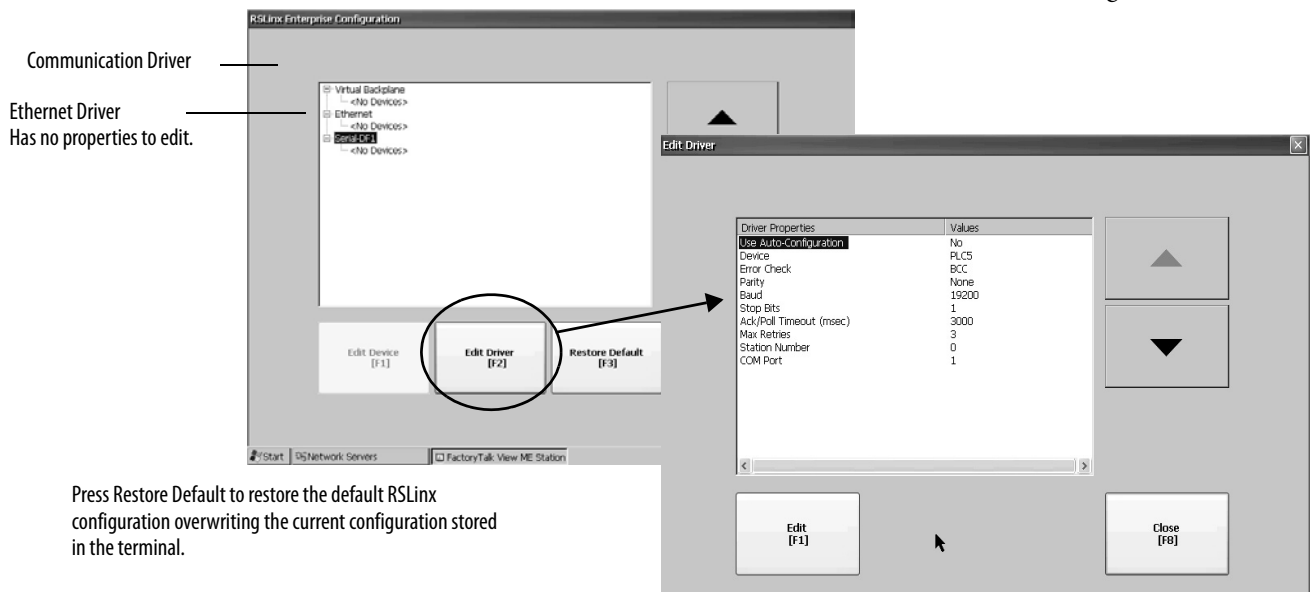

2. Select a communication card installed on your terminal.
3. Press Edit Driver to view the current driver properties.
4. Select a property to modify, then press Edit.
5. Modify the setting, then press Enter.

You return to the previous dialog box with the newly entered data.



**Table 46 - Communication Driver Properties**

Field	Description	Valid Values
<b>Serial Properties</b>		
Use Auto Config	Automatically or manually configures the baud rate, parity, and error checking parameters.	Yes (auto configure) No (manual configure)
Device	The serial device terminal is connected to.	PLC-5 <sup>®</sup> , SLCT <sup>™</sup> , MicroLogix <sup>™</sup> , Logix Platform
Error Check	Type of error checking used. Error checking is automatically configured if Use Auto Config is set to Yes.	BCC, CRC
Parity	Type of parity used. Parity is automatically configured if Use Auto Config is set to Yes.	None, Odd, Even
Baud Rate	Data rate at which serial driver communicates. The baud rate is automatically configured if Use Auto Config is set to Yes.	110, 300, 600, 1200, 4800, 9600, 19200, 38400, 57600, 115200
Stop Bits	Number of stop bits used.	1 or 2
Ack/Poll Timeout	Ack/Poll timeout value in ms.	20...60,000 ms
Max Retries	Number of retries before serial driver fails.	0...10
Station Number	Station number based on a specific device.	0...254
COM Port	Communication port used on the terminal.	1...4
<b>DHPlus Properties</b>		
Jumper ID	Identifies the communication card if multiple cards are installed on terminal.	0...3
Station Number	The unique address of terminal on the DHPlus network.	0...77 (octal)
Baud Rate	The communication rate of the DHPlus network.	57,600 (default) 115,200 230,400
<b>DH-485 Properties</b>		
Jumper ID	Identifies the communication card if multiple cards are installed on terminal.	0...3
Station Number	The unique station number of the terminal on the DH-485 network.	0...31 (decimal)
Baud Rate	The communication rate of the DH-485 network.	9600 19200
MaxStationNumber	The maximum station number on the DH-485 network. The value must be greater than or equal to the Station Number.	0...31 (decimal)
<b>ControlNet Properties</b>		
Device ID	Unique address of the PanelView Plus 6 terminal on the ControlNet network.	1...99

## Configure a Device Address

Follow these steps to edit the address of a device such as a logic controller.

1. From the RSLinx Configuration dialog box, select a device node.
2. Press Edit Device to view the device name and current address.

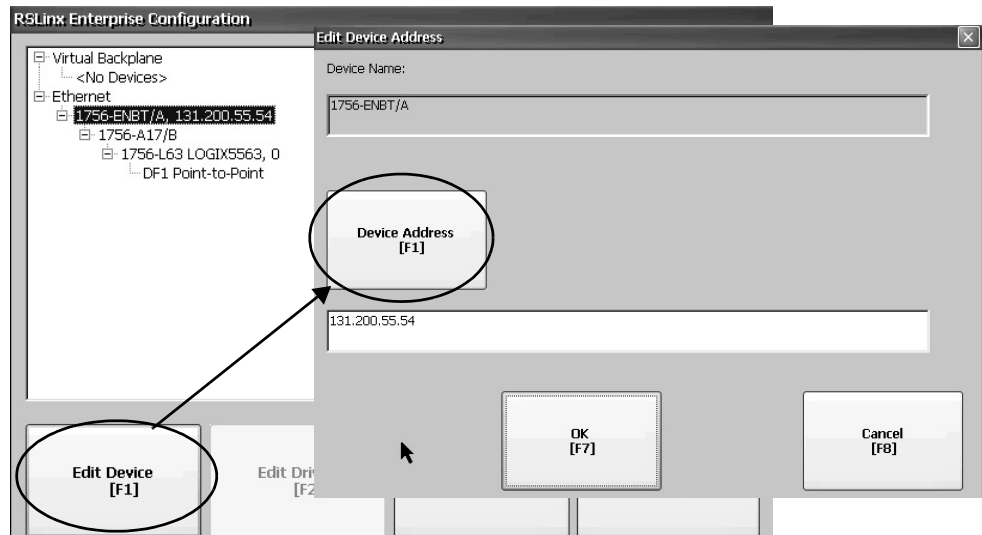

3. Press Device Address to modify the address.  
The input panel opens with the current address.
4. Use the Input Panel to modify the address and then press Enter.  
You return to the previous dialog box with the new address.
5. Press OK.  
Modified settings do not take effect until the terminal is restarted.

## Ethernet Network Connections

The terminal has a built-in Ethernet driver. You can configure this Ethernet information for your terminal:

- IP address of terminal on network including link speed
- Device name to identify terminal on network
- Username and password to access network resources

---

**IMPORTANT** FactoryTalk View ME Station does not recognize an installed 2711P-RN20 Ethernet module. View and manually configure the module's IP address from the control panel by using Network and Dial-up Connections.

---

## Set the Ethernet IP Address for the Terminal

Some networks automatically assign IP addresses to Ethernet devices if DHCP is enabled. If DHCP is not enabled, you can manually enter an IP address.

Follow these steps to view or enter the IP address of your terminal.

1. Press Terminal Settings>Networks then Communications>Network Connections>Network Adapters.

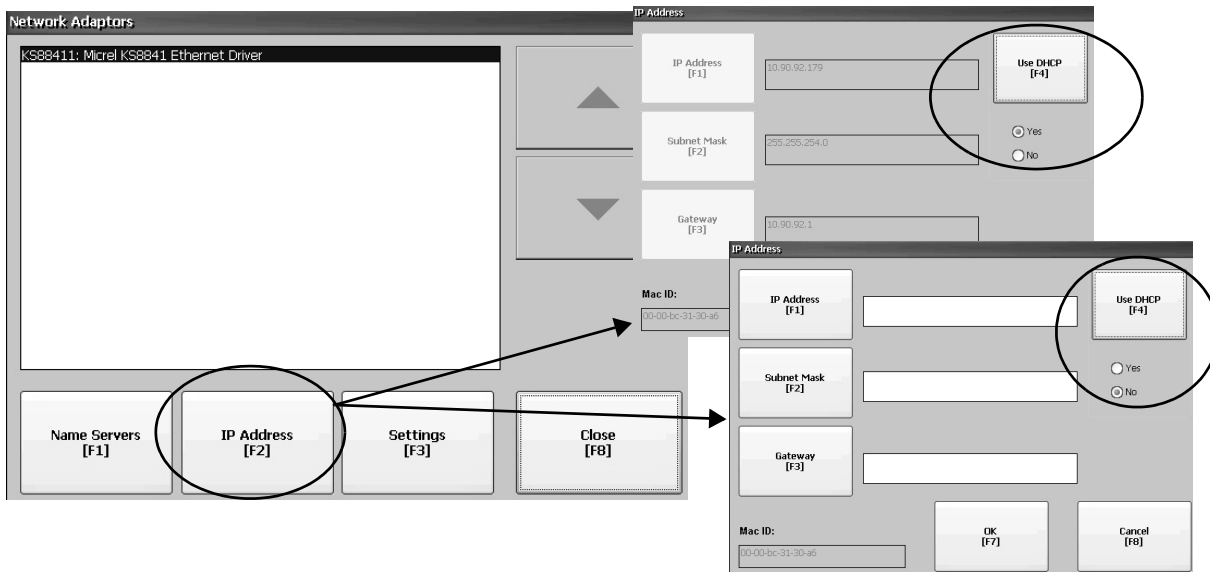

2. Press IP Address to view or modify the IP address.
3. Press Use DHCP to enable or disable DHCP assignment of addresses:
  - If DHCP is enabled or set to Yes, IP address are automatically assigned.
  - If DHCP is disabled, you can manually enter IP address. Press IP address, Subnet Mask, and Gateway to enter IP formatted addresses.
4. Press OK when done.

If prompted, reset the device from the FactoryTalk View ME Station Configuration mode dialog box.

5. Press Close.

Field	Description	Valid Values
Use DHCP	Enables or disables Dynamic Host Configuration Protocol (DHCP) settings. DHCP automatically allocates network devices and configurations to newly attached devices on the network: <ul style="list-style-type: none"> <li>• If DHCP is set to Yes, the terminal is automatically assigned an IP address, Subnet Mask, and Gateway. The fields are disabled.</li> <li>• If DHCP is set to No, you can enter the IP address, Subnet Mask, and Gateway address.</li> </ul>	Yes (default) No
IP Address	A unique address identifying the terminal on the Ethernet network.	xxx.xxx.xxx.xxx 000.000.000.000 (default) <ul style="list-style-type: none"> <li>• Range of values for the first set of decimal numbers is 1...255 unless all fields are set to 000.</li> <li>• The range of values for the last three sets of decimal numbers is 0...255.</li> </ul>
Subnet Mask	Address must be identical to the server subnet mask.	xxx.xxx.xxx.xxx
Gateway	Optional Gateway address.	xxx.xxx.xxx.xxx
Mac ID	Read-only field.	

## Set the Ethernet Link Speed

You can set the speed and duplex setting of the Ethernet link.

**TIP** Link settings for the 2711P-RN20 Ethernet module cannot be set in FactoryTalk View Machine Edition Station. The module is set to automatically sense the settings on the network.

1. Press Terminal Settings>Networks then Communications>Network Connections>Network Adapters.

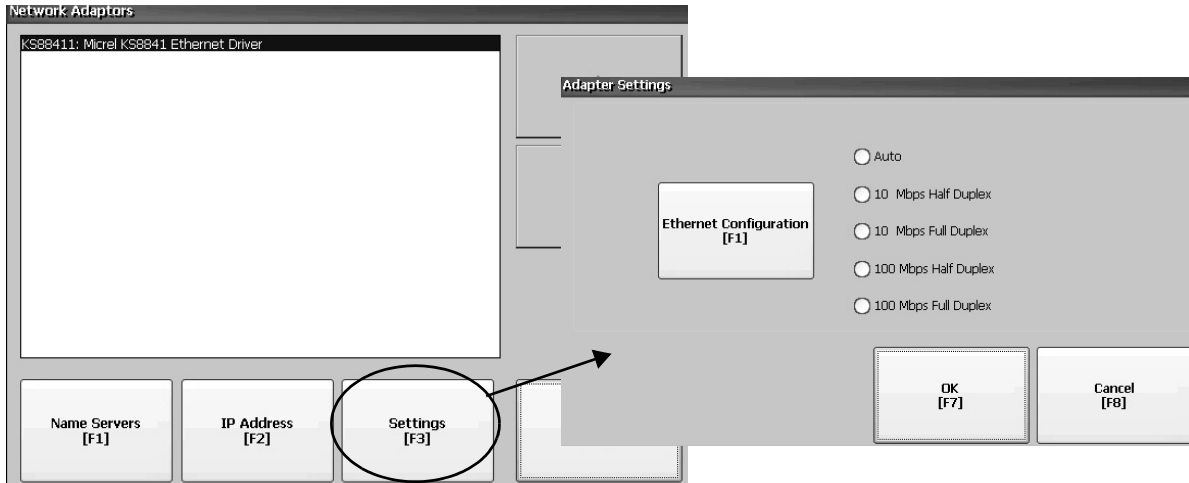

2. Press Settings to view or modify the Ethernet link settings.
3. Press Ethernet Configuration to select an Ethernet link option for your Ethernet connection.

The Auto option automatically senses the link option and speed based on the terminal connection to a network.

## Define Name Server Addresses

You can define name server addresses for the EtherNet/IP network adapter. These addresses are automatically assigned if DHCP is enabled for the adapter.

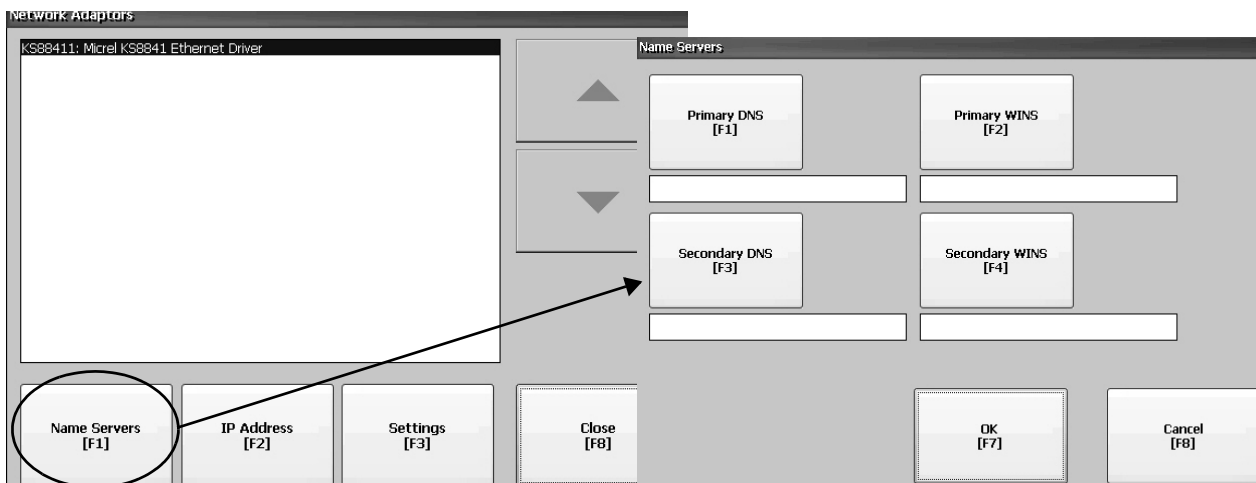

Follow these steps to define a name server address.

1. Press Terminal Settings>Networks then Communications>Network Connections>Network Adapters.
2. Press Name Servers.
3. Press the following fields to enter a name server address.

Field	Description	Valid Values
Primary DNS	The address of the primary DNS resolver.	XXX.XXX.XXX.XXX
Secondary DNS	The address of the secondary DNS resolver.	XXX.XXX.XXX.XXX
Primary WINS	The address of the primary WINS resolver.	XXX.XXX.XXX.XXX
Secondary WINS	The address of the secondary WINS resolver.	XXX.XXX.XXX.XXX

4. Press OK when done.

### View or Change Terminal Device Name

Each terminal has a default device name and description that is used to identify the terminal on the network. You can view or modify this information.

1. Press Terminal Settings>Networks then Communications>Network Connections>Device Name.

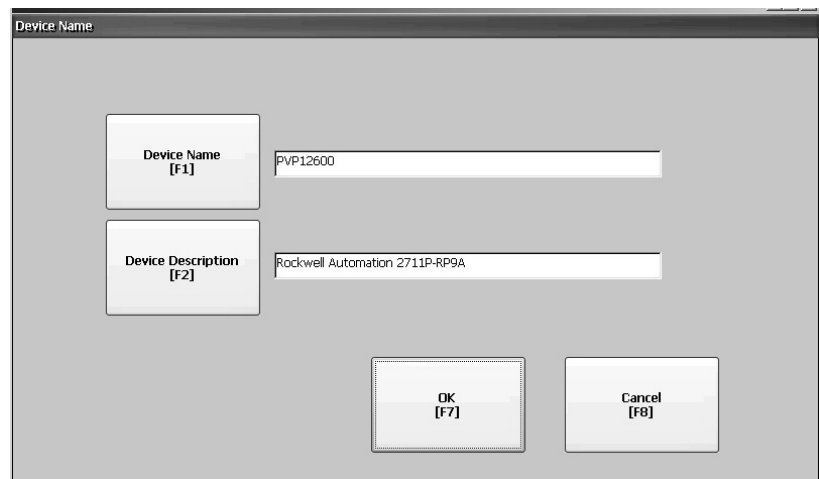

2. Press Device Name to enter or edit the device name.
3. Press Device Description to enter a description for the device.

Field	Description	Valid Values
Device Name <sup>(1)</sup>	Unique name that identifies the terminal to other computers on the network.	1...15 characters <ul style="list-style-type: none"> <li>• A leading character in the range of a through z or A through Z.</li> <li>• Remaining characters in the range of a through z, A through Z, 0...9, or - (hyphen)</li> </ul>
Device Description	Provides a description of the terminal. The default is device catalog number.	50 characters max

(1) Check with your network administrator to determine a valid device name.

4. Press OK.

## Authorize Terminal to Access Network Resources

The terminal can access network resources with proper identification. A user name, password, and domain must be provided by your network administrator.

1. Press Terminal Settings>Network then Communications>Network Connections>Network Identification.

The screenshot shows a terminal screen with three input fields stacked vertically. The first field is labeled 'User Name [F1]', the second is 'Password [F2]', and the third is 'Domain [F3]'. Each field has a white text input area. At the bottom of the screen, there are two buttons: 'OK [F7]' and 'Cancel [F8]'.

2. Press user name, password, and domain to enter the information provided by your network administrator.

Field	Description	Valid Values
User Name	Identifies the user to the network.	70 characters max
Password	Characters that gain access to network along with the user name.	No character limitation
Domain Name	Provided by network administrator.	15 characters max

3. Press OK when done.

## File Management

The terminal supports operations for managing files that are stored on the terminal:

- Deleting application .mer files, font files, or generated log files
- Copying application files or font files between storage locations

### Delete Application File or Font File

You can delete FactoryTalk View ME Station .mer files or font files that reside in nonvolatile memory of the terminal, a loaded USB flash drive, or a loaded SD card. The procedure for deleting an application file or a font file is the same.

1. Press Terminal Settings>File Management>Delete Files>Delete Applications or Delete Fonts.

2. Press Source to select the storage location of the application or font file you want to delete:
  - Internal Storage - nonvolatile memory of the terminal
  - External Storage 1 - SD card loaded in the card slot of the terminal
  - External Storage 2 - USB flash drive connected to a USB host port

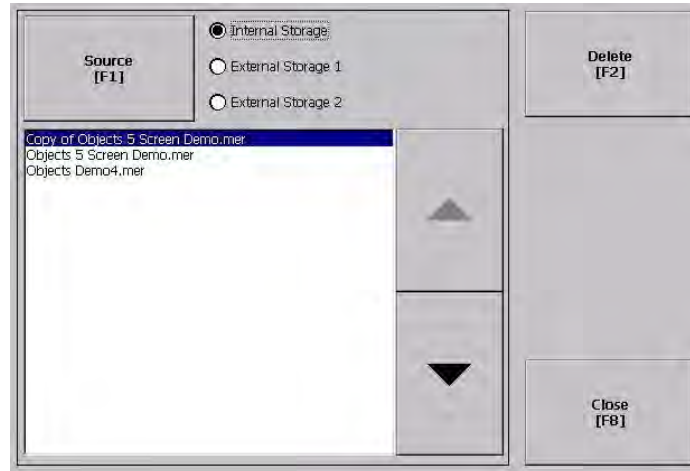

3. Select a file from the list.
4. Press Delete.
5. Select Yes or No when asked if you want to delete the selected application or font file from the storage location.

## Delete Log Files

You can delete generated log files, alarm history files, and alarm status files from the System Default location on the terminal.

1. Press Terminal Settings>File Management>Delete Files>Delete Log Files.  
You are asked to confirm the deletion of the files.

Do you want to delete all of the FactoryTalk View ME Station Log Files?

2. Select Yes or No.

Log files not in the System Default location are not be deleted.

## Copy Application File or Font File

You can copy FactoryTalk View ME Station application .mer files or font files from one storage location to another in the terminal. The procedure for copying an application file or a font file between storage locations is the same.

1. Press Terminal Settings>File Management>Copy Files>Copy Applications or Copy Fonts.

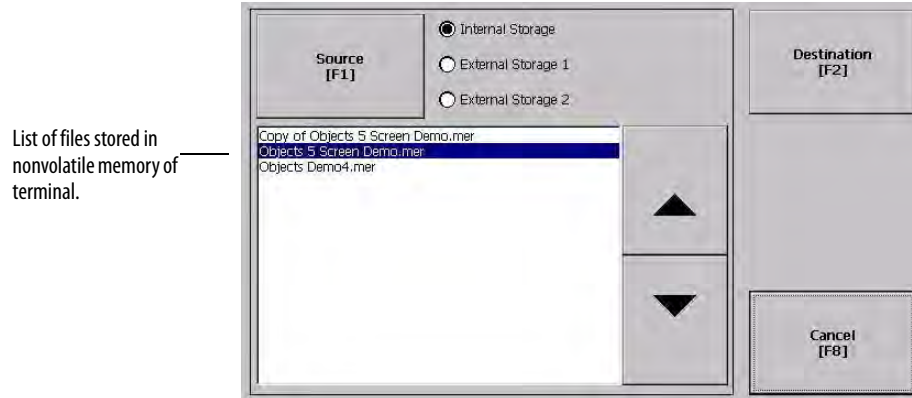

2. Press Source to select the location of the file you want to copy:
  - Internal Storage - nonvolatile memory of the terminal
  - External Storage 1 - SD card loaded in the card slot of the terminal
  - External Storage 2 - USB flash drive connected to a USB host port
3. Select a file from the storage location.
4. Press Destination on the same dialog box.

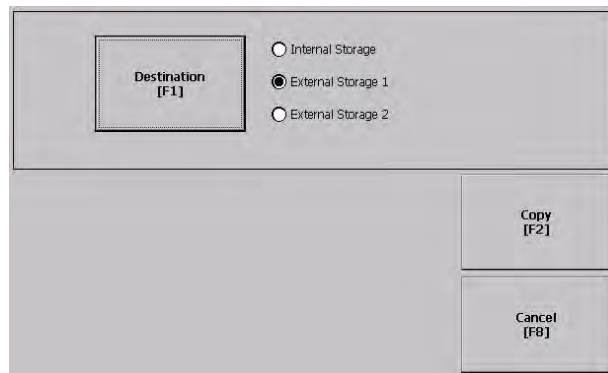

5. Press Destination to select the location to copy the file. The destination must be different than the source location.
6. Press Copy to copy the selected file to the destination. If the file exists, you are asked if you want to overwrite the file.
7. Select Yes or No.

**TIP** FactoryTalk View ME Station software looks for .mer files in the My Device\Application Data\Rockwell Software\RSViewME\Runtime\ folder and font files in the \Rockwell Software\RSViewME\Fonts\ folder.



## Display Settings

For the terminal display, you can adjust its intensity, view its temperature, configure the screen saver, or enable/disable the screen cursor.

### Adjust the Display Intensity

You can modify the intensity of the terminal backlight. You can use the default intensity of 100% or you can change the intensity for runtime operations.

1. Press Terminal Settings>Display>Display Intensity.

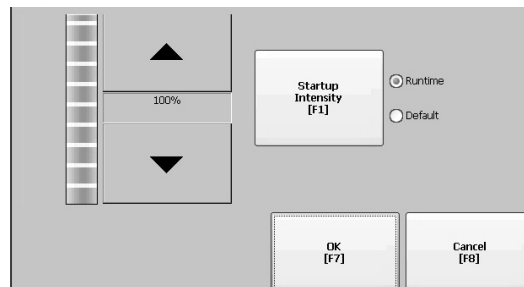

2. Press Startup Intensity to switch between the Default intensity and the Runtime intensity.
  - If you select Runtime, the start-up screens use the runtime intensity.
  - If you select Default, the start-up screens use the default setting, 100%
3. Increase or decrease the intensity for runtime operations, by pressing the up or down arrow keys.
4. Press OK when done to save the intensity changes.

### View the Display Temperature

To view the current temperature of the 700 to 1500 CCFL-displays only, press Terminal Settings>Display>Display Temperature.



700 to 1500 terminals with a cold-cathode fluorescent lamp (CCFL) backlight require temperature control when the internal temperature of the product is below 10 °C (50 °F) or above 60 °C (140 °F). If the internal temperature is:

- Below 10 °C (50 °F), the backlight is set to overdrive or the full-rated current setting for at least five minutes. This increases heat generation from the backlight.
- Above 60 °C (140 °F), the backlight is set to underdrive; 40% or less of full brightness. This reduces heat generation from the backlight.

Temperature monitoring begins when the backlight turns on at startup or when the screen saver is deactivated. The temperature control affects display intensity only; it does not restrict the use or operation of the terminal.

When a low or high temperature condition is detected, an error is sent to the system event log. If the temperature control is not functioning, a noncritical error is sent to the system event log but the terminal continues to operate normally.

**TIP** Temperature control takes precedence over the application backlight settings.

## Configure the Screen Saver

The screen saver on the terminal activates after an idle period at a specific intensity. The default idle timeout is 10 minutes. You can adjust the idle timeout and intensity level for the screen saver, disable the screen saver, and enable or disable the screen saver bitmap.

1. Press Terminal Settings>Display>Screen Saver.

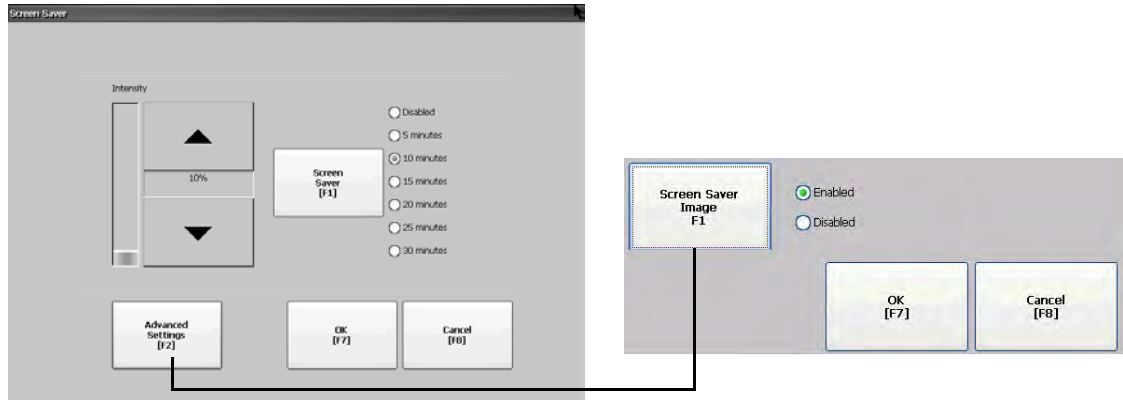

2. Press Screen Saver to select an idle timeout for activating the screen saver. To disable the screen saver, select the Disabled option.
3. Increase or decrease the brightness intensity of the screen saver by pressing the up and down cursor buttons.
4. Press Advanced Settings to access the bitmap option.
  - a. Press Screen Saver Image to enable or disable the screen saver bitmap. Refer to [Screen Saver on page 95](#) for details on how to set the bitmap.
  - b. Press OK to return to the previous.
5. Press OK to exit and return to the terminal settings.

## Enable or Disable the Screen Cursor

The terminal has a screen cursor that you can enable or disable.

1. Press Terminal Settings>Display>Cursor.

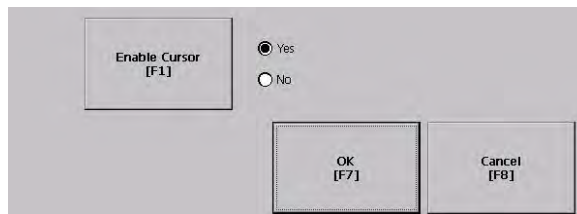

2. Press Enable Cursor to enable or disable the cursor.
3. Press OK to exit and return to Terminal Settings.

## Input Device Settings

You can adjust the settings for input devices used by the terminal including the keypad, attached keyboard, mouse, touch screen, and string entry popup.

### Configure Keyboard or Keypad Settings

You can adjust settings for keys on an attached keyboard or the terminal keypad.

1. Press Terminal Settings>Input Devices>Keyboard/Keypad.

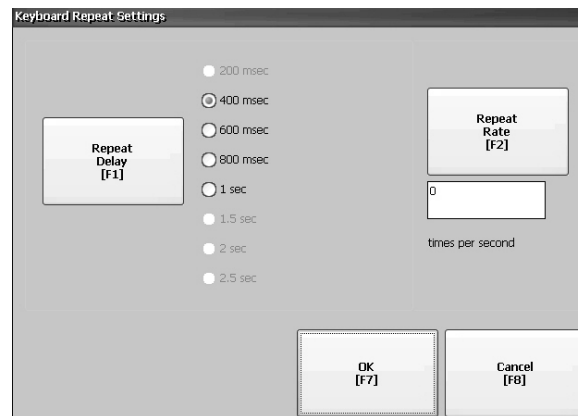

2. Press Repeat Rate to specify the number of times a key is repeated per second when you hold a key down.  
Valid values for the keypad are 0 and 2...30. The keyboard is device dependent but typical values are the same.
3. Press Repeat Delay to select the amount of time that elapses per second before a key is repeated.  
Values are device dependent. Unsupported values are dimmed.
4. Press OK when done.

### Set the Sensitivity of the Mouse

You can set and test the sensitivity for both the speed and physical distance between mouse clicks. The process is identical to setting the double-tap sensitivity for the touch screen. See [page 69](#).

To set the mouse sensitivity, press Terminal Settings>Input Devices>Mouse.

## Change the Popup for String Entry

You can specify whether to use the standard input panel for data entry or a string popup. The popup keyboard is the default.

1. Press Terminal Settings>Input Devices>String Popup.

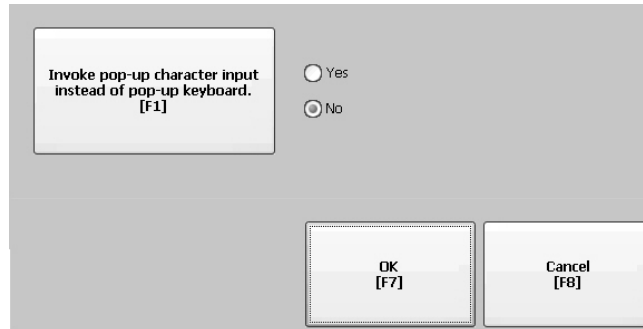

2. Press Invoke pop-up character input instead of popup keyboard to select the preferred input method for string entry.
3. Press OK.

## Calibrate a Touch Screen

Follow these steps to calibrate the touch screen.

---

**IMPORTANT** Use a plastic stylus device with a minimum tip radius of 1.3 mm (0.051 in.) to prevent damage to the touch screen.

---

1. Press Terminal Settings>Input Devices>Touch Screen>Calibration.

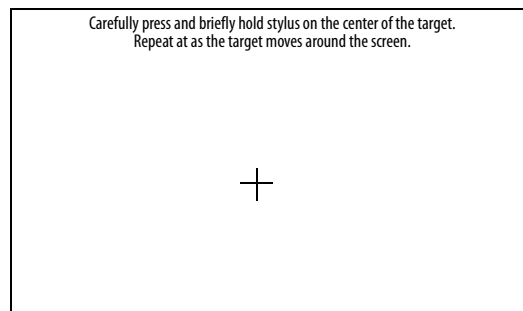

2. Follow the instructions on the screen.

When the calibration is complete, you see a message that indicates new calibration settings have been measured.

On terminals with a touch screen only	<ul style="list-style-type: none"> <li>• Press the screen to register saved data.</li> <li>• Wait for 30 seconds to cancel saved data and keep the current settings.</li> </ul>
On terminals with a keypad and touch screen	<ul style="list-style-type: none"> <li>• Press the Enter key to accept new settings</li> <li>• Press the Esc key to keep old settings.</li> </ul>

## Set Double-tap Sensitivity for a Touch Screen

You can set and test the sensitivity for both the speed and physical distance between touch-screen presses. The process is identical to setting the double-click sensitivity for the mouse.

1. Press Terminal Settings>Input Devices>Touch Screen>Double Tap Sensitivity.

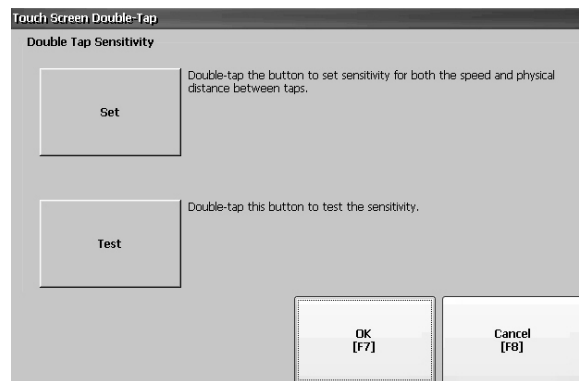

2. Double-tap Set to set the sensitivity of touch-screen presses.
3. Double-tap Test to test the sensitivity of touch-screen presses. The Test button reverses its foreground and background colors.
4. Press OK when done.

## Configure Print Options

You can configure settings for printing displays, alarm messages, or diagnostic messages from FactoryTalk View ME Station applications. The setup for printing displays and messages is the same; advanced settings are different.

PanelView Plus 6 terminals are shipped with support for a large selection of Canon, Epson, Hewlett-Packard, and Brother Printers. Printer installation attempts to use USB Plug-and-Play capabilities to the extent that known printers are mapped automatically to the appropriate driver. The printing solution lets applications and users to select, manage, and share printers without knowing the underlying details of the printer. Printers that do not configure automatically to the appropriate driver can be installed manually.

Follow these steps to access the print setup.

1. Press a Terminal Settings>Print Setup> option:
  - Alarm Print Setup
  - Diagnostic Setup
  - Display Print Setup

Print Setup displays installed printers that are available to the FactoryTalk View Machine Edition application.

The terminals are not shipped with pre-configured printers so initially the dialog box appears empty. The appearance of the dialog box depends on what printers you install.

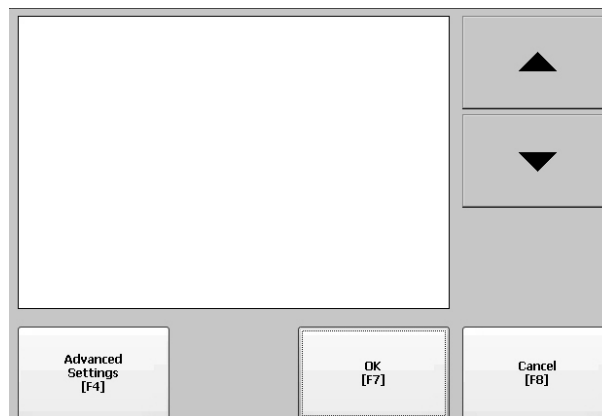

2. Select an installed printer.

**TIP**

The printer you select must be listed in Control Panel Printers applet. For a list of supported printers, go to: <http://www.rockwellautomation.com/knowledgebase> and search the Knowledgebase for ID 111636.

A failed attempt to automatically install a printer is reported in the system event log.

A printer that does not install automatically can be installed manually by using the control panel in Windows Explorer.

3. Press Advanced to access additional settings:
  - Advanced settings for printing displays include these:
    - Print orientation (portrait or landscape)
    - Draft mode (enable or disable)
    - Color (yes or no)
  - Advanced settings for printing diagnostic and alarm messages determines when to print messages sent to the network or USB port.

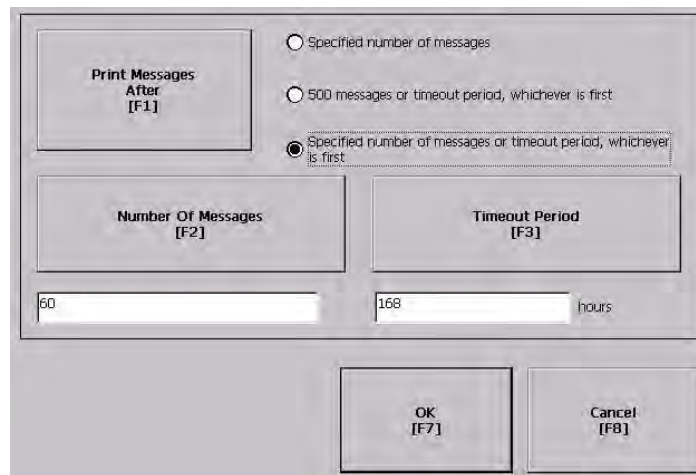

Print Messages After	Default Value	Example
Specified number of messages	60 messages	When the queue has 60 messages, the messages are printed regardless of how long they have been in the queue. You can change the number of messages.
500 messages or timeout period, whichever is first	168 hours (7 days)	If the queue has 350 messages after 168 hours, the 350 messages are printed. You can change the timeout period.
Specified number of messages or timeout period, whichever is first.	60 messages 168 hours (7 days)	If the queue has 60 messages after 24 hours, then the 60 messages are printed. You can change the number of messages and the timeout period.  For example, the number of messages is set to 75 and the timeout period is set to 48 hours. <ul style="list-style-type: none"> <li>• If the queue has 75 messages after 24 hours, then the 75 messages are printed before the set timeout of 48 hours.</li> <li>• If the queue has 15 messages after 48 hours, the 15 messages are printed after the set timeout period.</li> </ul>

4. Press OK when done.
5. Press OK to return to Terminal Settings.

## Check Integrity of Application Files

Periodically check the integrity of the FactoryTalk View ME Station application that is loaded in the terminal and the runtime files. All errors, warnings, and information messages generated by these files are logged to a file. You can periodically view the log and clear all items from the log.

1. Press Terminal Settings>File Integrity Check.

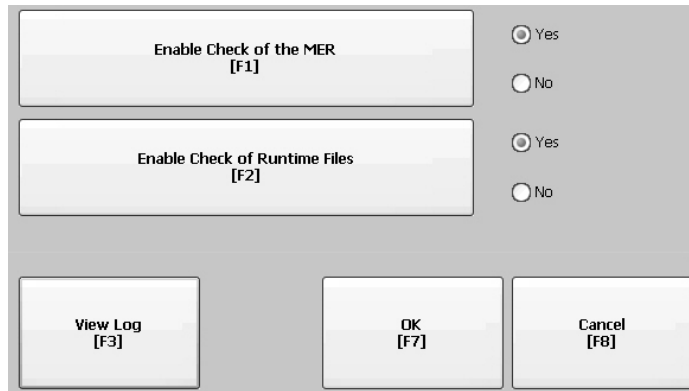

2. Press either of the Enable options to enable or disable file integrity checks:
  - Enable Check of the MER
  - Enable Check of the Runtime Files

By default, integrity checks are automatically performed on the application .mer file and runtime files. If you disable either of these functions, the files are not checked and the log file is not updated.

3. Press OK to save changes.

Follow these steps to view the file integrity check log.

1. Press View Log from the File Integrity Check dialog box.

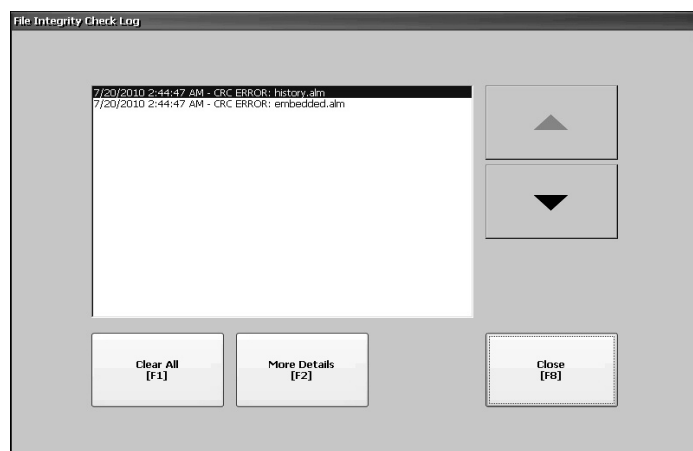

2. Select an event and press More Details to display details for a specific file check event.
3. Press Clear All to clear all details from the log.
4. Press Close to return to previous dialog box.



## Configure Diagnostics

You can configure diagnostics for a target computer. To access diagnostics, press Terminal Settings>Diagnostic Setup from the Configuration Mode dialog box. You see a tree view of diagnostic nodes.

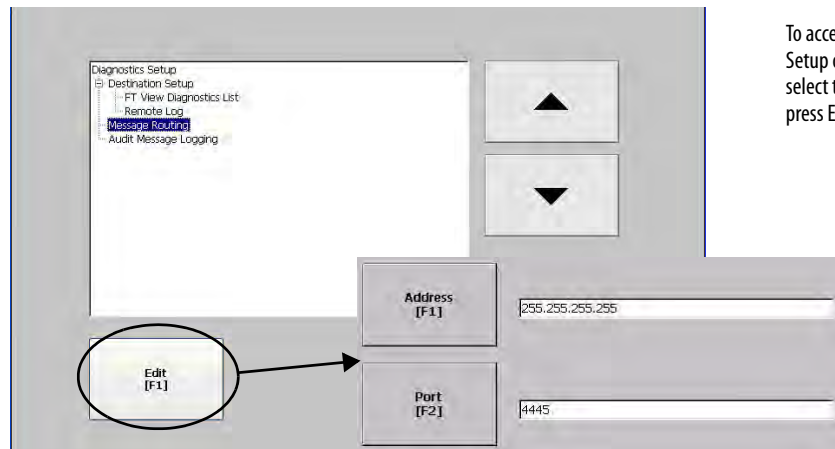

To access the Remote Log Setup or Message Routing, select the node and then press Edit.

The Remote Log Destination forwards received messages to a Windows computer running diagnostics. The location is determined by the IP address and port number.

Field	Description	Valid Values
Address	Address of the remote Windows computer.	xxx.xxx.xxx.xxx
Port	The port used to communicate with the remote Windows computer.	4445 (default)

The Message Routing dialog box lets you access these dialog boxes:

- Remote Log
- FactoryTalk View Diagnostics List

Each dialog box shows a list of messages that can be sent to that destination. The list shows the status of each message type. Press On/Off to turn a message type on or off. A message type is enabled if it has a checked box.



The Audit Message Logging dialog box lets you log messages as Audit or Information when Edit is pressed.

## View and Clear the System Event Log

The System Event Log dialog box displays warnings, errors, and events logged by the terminal. The log provides a time stamp of when each event occurred and text describing the event. If the event log is full when a new event occurs, the oldest entry is removed to accommodate the new event.

1. Press Terminal Settings>System Event Log.

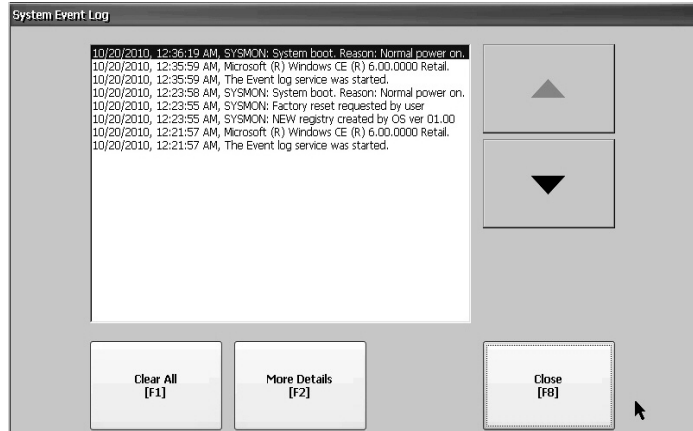

2. Select an event and press More Details to display log details for that event.
3. Press Clear All to clear all system event logs.
4. Press Close.

## System Information

You can view terminal and firmware revision information for software installed on a terminal. This information can be useful during troubleshooting.

### View Terminal Information

This read-only information is provided for the terminal:

- Total power on time in minutes
- Processor temperature (700 to 1500 terminals only)
- Battery voltage and state
- Memory allocated and used on terminal
- RAM memory used during runtime

Follow these steps to display terminal information.

1. Press Terminal Settings>System Information>Terminal Information.

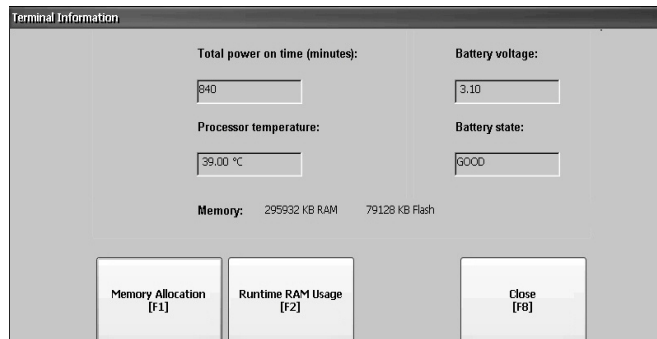

- The CPU temperature must be less than 95 °C (203 °F).
- The battery voltage must be at least 2.75V DC.

Battery State	Description
Good	Good battery condition.
Failing	Low battery. Replace the battery.
Bad	Battery is missing or bad. Replace the battery.

2. Press Memory Allocation to view the following:
  - Amount of allocated storage or program memory
  - Amount of storage or program memory in use
  - Amount of available nonvolatile memory

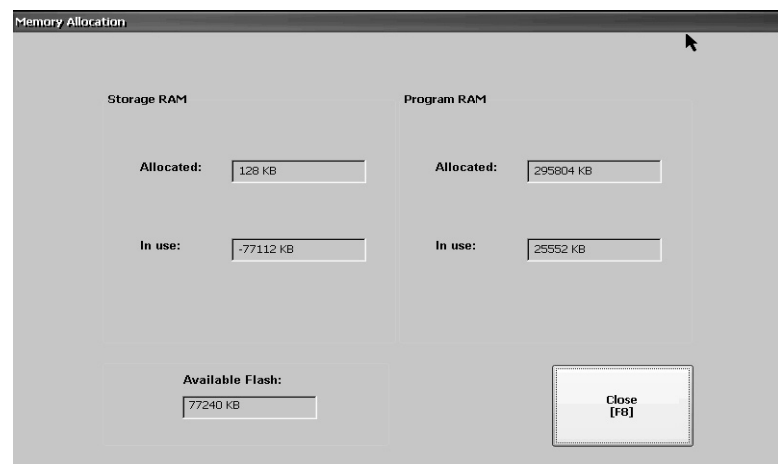

3. Press Close to return to previous dialog box.
4. Press Runtime RAM Usage to troubleshoot runtime anomalies by showing the amount of RAM used by your application at runtime.

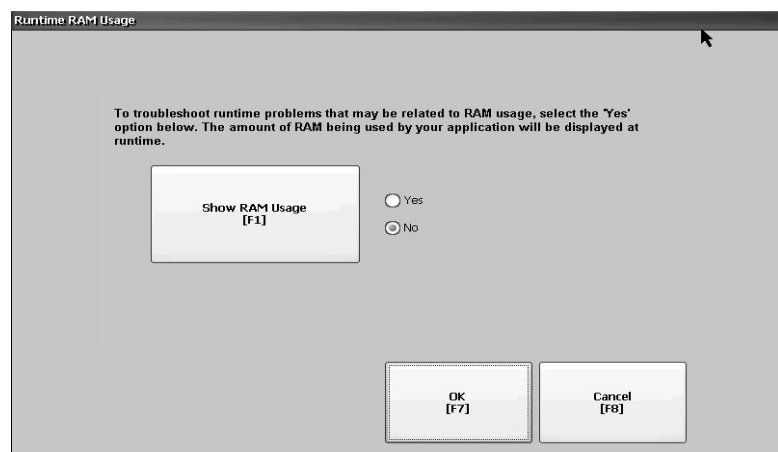

5. Press OK to return to previous dialog box.
6. Press Close until you return to terminal settings.

## Display FactoryTalk View ME Station Information

You can display the firmware and version information for installed system components on your terminal and technical support information.

1. Press Terminal Settings>System Information>About FactoryTalk View ME Station.

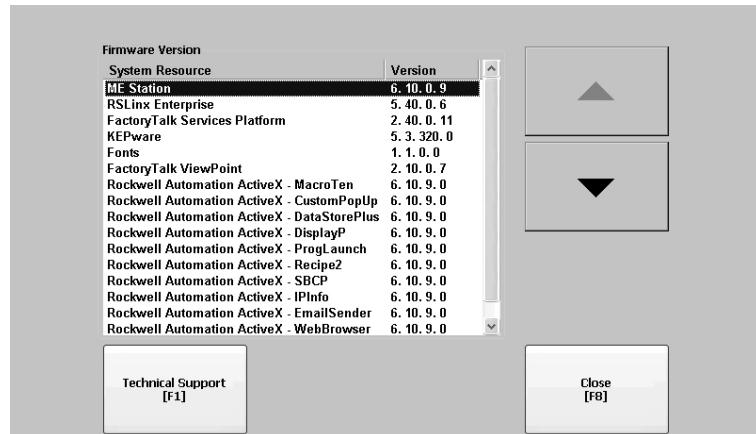

2. Press Technical Support to display the support phone number and website for your terminal.
3. Press Close until you return to terminal settings.

## Enable or Disable the Alarm Display

Each new alarm that occurs on the terminal is displayed in the alarm display or banner. When the newest alarm is acknowledged by the operator, you can choose to close the alarm display or leave it open. By default the alarm display is closed.

1. Press Terminal Settings>Alarms.

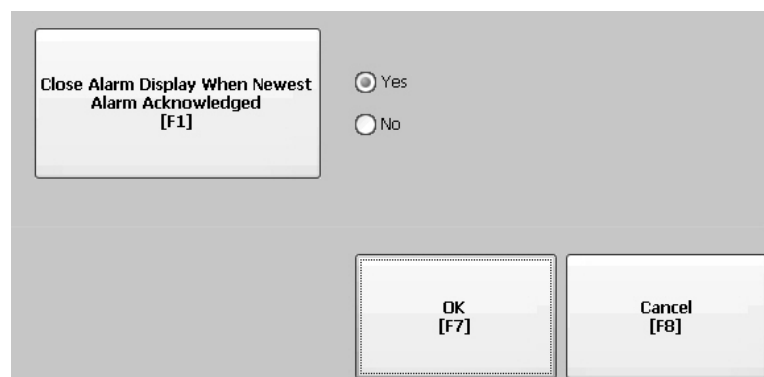

2. Press Yes or No:
  - Yes, the default option, closes the alarm display each time the operator acknowledges the newest alarm.
  - No leaves the alarm display open after the operator acknowledges the newest alarm.
3. Press OK.

## Time and Date Settings

You can change the date, time, time zone, and regional settings for terminal operations.

### Change the Date for Terminal Operations

Follow these steps to adjust the date for terminal operations.

1. Press Terminal Settings>Time/Date/Regional Settings>Date.

The current date appears in the Year, Month, and Day fields.

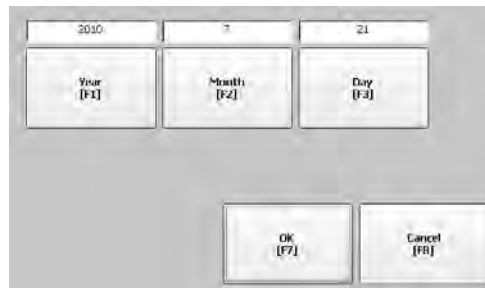

2. Press Year, Month, and Day to change the values.

Field	Description	Valid Values
Year	The current year in a four-digit format.	1980...2099
Month	The current month.	1...12
Day	The current day. The day of the month is validated.	0...31

3. Press OK when done.

### Change the Time for Terminal Operations

Follow these steps to adjust the time for terminal operations.

1. Press Terminal Settings>Time/Date/Regional Settings>Time.

The current time appears in 24-hour format in separate Hour, Minute, and Second fields.

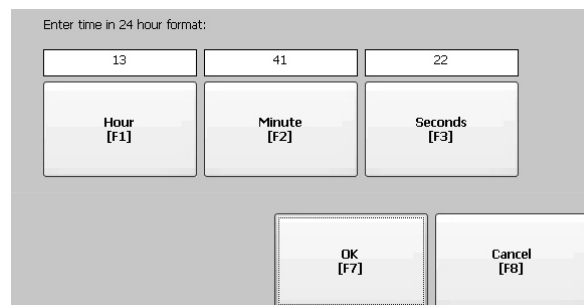

2. Press Hour, Minute, and Seconds to change the values.

Field	Description	Valid Values
Hour	The current hour in 24-hour format.	0...23
Minute	The current minute in 24-hour format.	0...59
Seconds	The current second in 24-hour format.	0...59

3. Press OK when done.

## Change the Time Zone for Terminal Operations

You can view or modify the current time zone that is installed on the terminal. Time zones are installed as a part of the operating system. Changing the time zone adjusts the current time and date to match the new time zone.

1. Press Terminal Settings>Time/Date/Regional Settings>Time Zone.

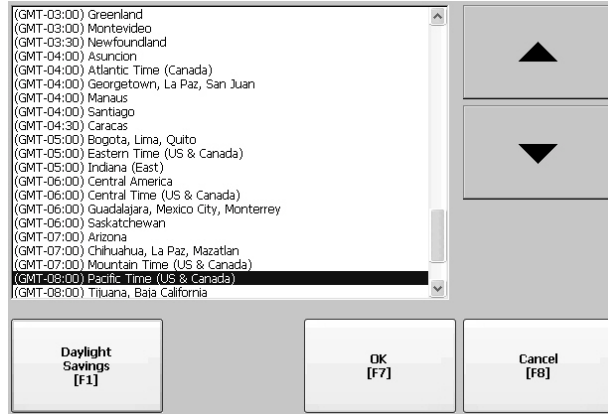

2. Press the up or down cursor to select a time zone.

Language	Default Time Zone
English	(GMT -05:00) Eastern Time (US and Canada)
French	(GMT +01:00) Brussels, Copenhagen, Madrid, Paris
German	(GMT +01:00) Amsterdam, Berlin, Bern, Rome, Stockholm, Vienna
Japanese	(GMT +09:00) Osaka, Sapporo, Tokyo

If the selected time zone supports daylight savings, you can press Daylight Savings.

3. Press Daylight Savings to enable or disable daylight savings for the selected time zone.

Daylight savings is set to Yes for all time zones except for Japanese, which does not support daylight savings. Daylight savings changes are not permanently applied until you close the Time Zone dialog box.

4. Press Use Daylight Savings to select Yes or No.

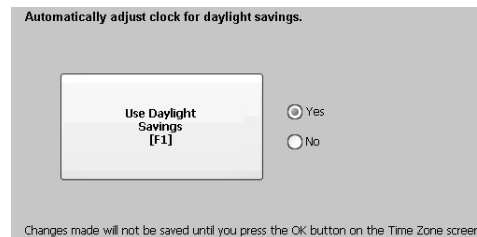

5. Press Close when done.
6. Press OK to return to previous dialog box.

## Regional Settings

You can adjust regional settings for a specific language installed on the terminal, including the date, time and numeric formats. Regional settings are accessed by pressing Terminal Settings>Time/Date/Regional Settings>Regional Settings. The current language is shown at the bottom of the Regional Settings dialo box.

### Select a Language

Before you can modify regional settings for a language, you need to select a language installed on the terminal. Languages are installed as a part of the operating system.

1. Press Terminal Settings>Time/Date/Regional Settings>Regional Settings>Language.

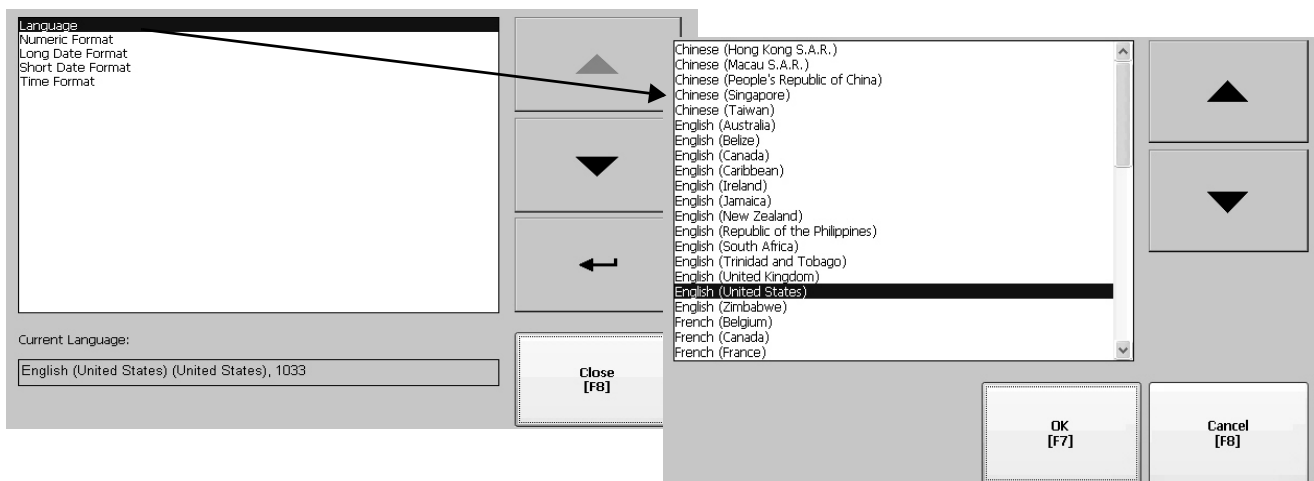

2. Select a language by pressing the up and down cursor keys.
3. Press OK.  
The selected language shows under Current Language on the Regional Settings dialog.

### Change the Decimal Separator for Numeric Formats

You can change the decimal separator used in numerics for the current language. The default decimal separator is a period.

1. Press Terminal Settings>Time/Date/Regional Settings>Regional Settings>Numeric Format.

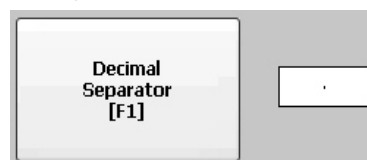

The field shows the default decimal separator. The field accepts a separator up to three characters.

2. Enter up to three characters for the new separator, then press OK.

## Change the Time Format for a Language

Follow these steps to change the time format for the selected language.

1. Press Terminal Settings>Time/Date/Regional Settings>Regional Settings>Time Format.

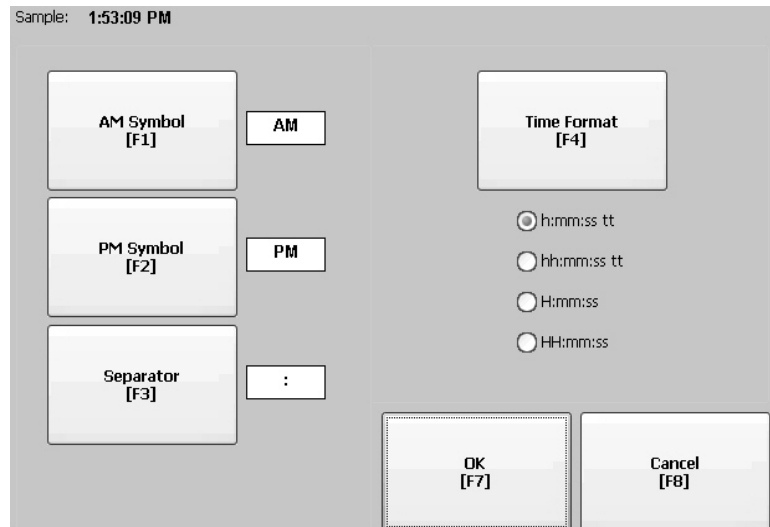

The current time is shown in the currently selected format.

2. Press the appropriate selections to adjust the formats.

Field	Description	Example
Time Format	h:mm:ss tt (default) h = hour, no leading zero tt = AM or PM symbol	7:23:02 AM or 1:13:31 PM 11:43:59 AM
	hh:mm:ss tt hh = hour with leading zero tt = AM or PM symbol	07:23:02 AM or 01:13:31 PM 11:43:59 PM
	H:mm:ss H = hour in 24-hour format, no leading zero	7:03:42 or 1:13:32 23:43:59
	HH:mm:ss HH = hour in 24-hour format with leading zero	07:03:42 or 01:13:22 23:43:59
AM Symbol	Characters to indicate AM. If the time format is set to h:mm:ss tt or hh:mm:ss tt, you can modify the AM symbol.	AM (default) 12 character max
PM Symbol	Characters to indicate PM. If the time format is set to h:mm:ss tt or hh:mm:ss tt, you can modify the PM symbol.	PM (default) 12 character max
Separator	Characters that separate fields in time format.	:(default) 3 character max

3. Press OK.



## Change the Short Date Format for a Language

Follow these steps to change the short date format for the selected language.

1. Press Terminal Settings>Time/Date/Regional Settings>Regional Settings>Short Date Format.

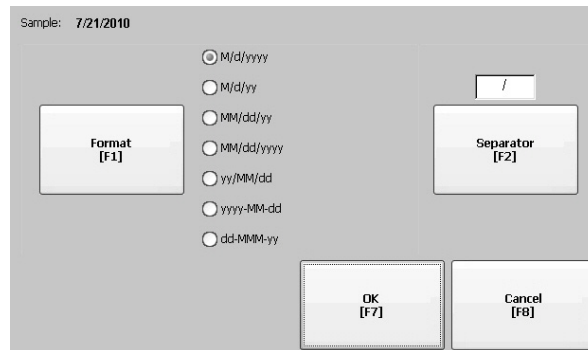

The Sample area shows the current date in the selected format.

2. Press Format to select an available format.

The date is updated in the Sample area as you make selections.

3. Press Separator to change the separator for the date elements.

The separator can be 3 characters. The default separators are – or /.

4. Press OK when done.

## Change the Long Date Format for a Language

Follow these steps to change the long date format used by the selected language.

1. Press Terminal Settings>Time/Date/Regional Settings>Regional Settings>Long Date Format.

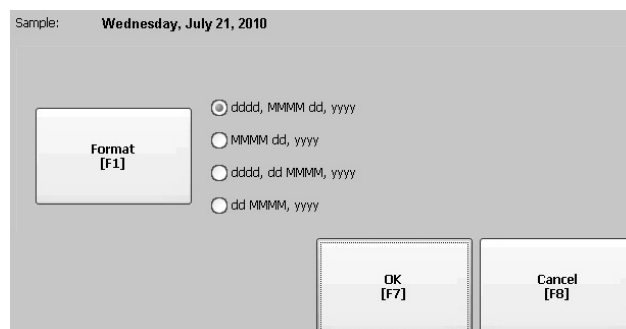

The Sample area shows the current date in the selected format.

2. Press Format to select an available format.

The date is updated in the Sample area as you make selections.

3. Press OK when done.

## Font Linking

Font linking lets you run a translated application on the terminal by linking a font file to the base font (for example, linking a Chinese font file to the base font Arial).

For more details on preinstalled terminal fonts and additional fonts available for downloading, see [Fonts Resident on Terminal on page 175](#).

Press Terminal Settings>Font Linking to access this function.

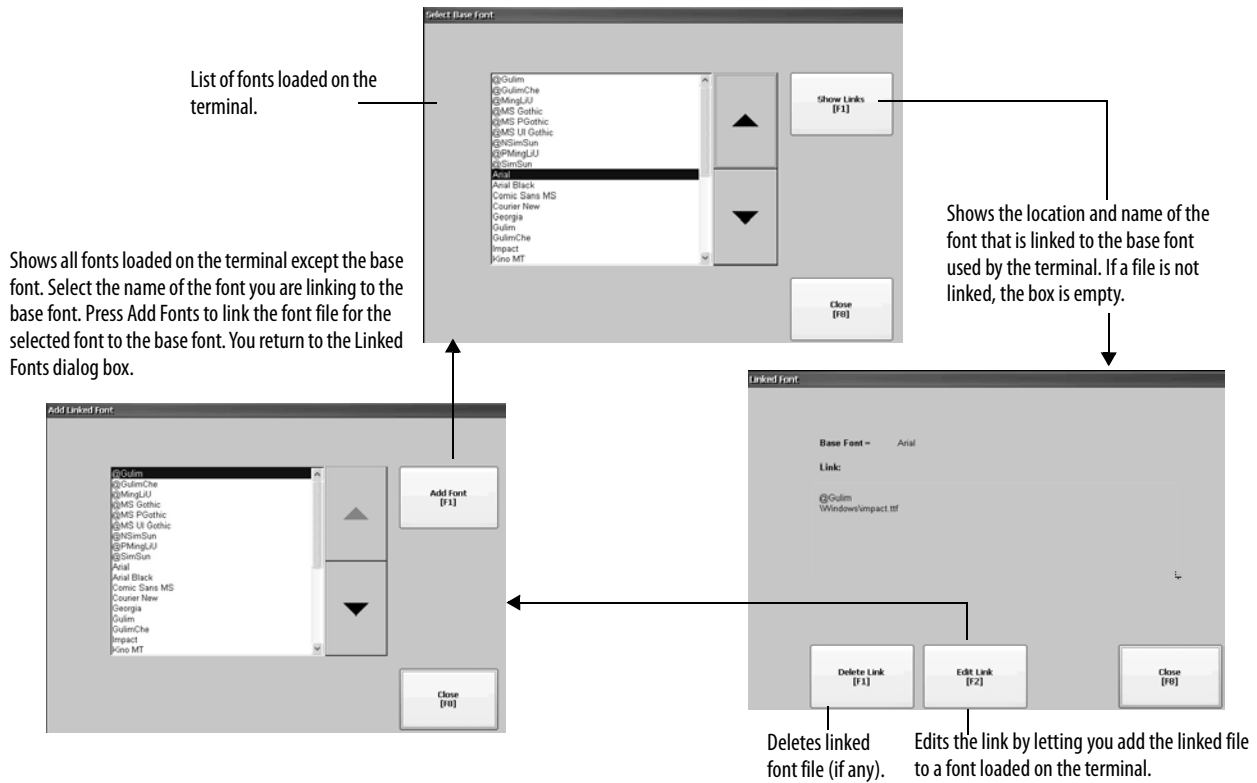

## Windows CE Operating System

Topic	Page
Windows CE 6.0 Standard Features	83
Windows CE 6.0 with Extended Features	85
Taskbar and Windows Explorer	86
Windows Control Panel	87
Backup and Restore	88
Hardware Monitor	91
Keypad Properties	93
Touch Properties	93
Display Properties	94
Logo Manager	96
System Information	97
User Accounts	97
Services	101
Network Server Configuration	102
Printer Support	111
PDF Reader	114

### Windows CE 6.0 Standard Features

The terminals run the Windows CE 6.0 operating system (OS) providing the following shell and user interface features:

- Command shell
- Command processor
- Console window
- Windows Explorer shell
- Mouse and touch screen support
- Common dialog box
- Control panel
- Network user interface
- Soft keyboard input panels
- PDF reader

- VNC server and client viewer

The platform distributes two VNC client viewers:

- Vncviewer.exe in the \Windows folder on the terminal can be deployed to a personal computer for connecting, viewing, and controlling the Windows CE terminal (PanelView™ Plus 6).
- Another viewer is available on the terminal to establish a VNC connection between two PanelView Plus 6 terminals. To access this VNC client, choose Start>Programs>VNC Viewer.

**TIP** The Windows Explorer shell supports right-click functionality. A touch screen press held for one second or longer produces a right-click.

## Application Support

The Windows CE 6.0 operating system provides application support in both the OS and the Software Development Kit (SDK):

- .Net Compact Framework, version 3.5 or later
- C++ libraries and runtimes
- Component services DCOM/COM/OLE
- Message queuing MSMQ
- MSXML, version 3.0 or later
- MFC for devices, version 8.0 or later
- ATL
- ActiveSync
- CAB file installer/uninstaller
- Toolhelp API
- Error reporting (generator, transfer driver, control panel)

## Scripting Support

The Windows CE 6.0 operating system supports these scripting features:

- Batch/command (BAT and CMD files)
- JScript
- VBScript
- CSScript

## Network Support

The Windows CE 6.0 operating system supports these network features:

- Winsock support
- Network utilities - ipconfig, ping, route
- Network Driver Architecture (NDIS)
- Windows Networking API/Redirector
- Wired Local Area Network, 802.3, 802.5

## Server Support

This table lists servers supported by the Windows CE 6.0 operating system.







**Table 47 - Windows CE 6.0 Server Support**

Server	Default State	Description
Web server	Enabled	The web server delivers content, such as web pages, by using the HTTP protocol over the Web.
FTP server	Enabled	File Transfer Protocol (FTP) is a standard network protocol for exchanging files over the Internet (TCP/IP-based network).
UPnP server	Enabled	Universal Plug and Play (UPnP) is a set of networking protocols that lets devices install and connect seamlessly to a network.
File Server	Disabled	A network protocol that provides shared access to files, printers, serial ports, and miscellaneous communication between computers on a network.
VNC server	Disabled	Virtual Network Computing (VNC) is a graphical desktop sharing system used to remotely control another computer. It transmits keyboard/mouse events from one computer to another, over a network.
ViewPoint Server	Enabled	Supported on PanelView Plus 6 - 700 to 1500 terminals. A web-server based application that provides remote user access via a web browser to the FactoryTalk View Machine Edition HMI application that is running on the terminal. ViewPoint software is a Rockwell Automation product.
	Disabled	Not supported on PanelView Plus 6 - 400 and 600 terminals.

## Windows CE 6.0 with Extended Features

Terminals and logic modules with extended features, catalog numbers 2711P-xxxxx9 and 2711P-RP9x, provide additional operating system components.

**Table 48 - Operating System with Extended Features**

Icon	Software	Icon	Software
	Microsoft Internet Explorer 6 web browser with Silverlight 2		Microsoft Office 2003 PowerPoint file viewer
	Adobe Flash Lite 3.1 ActiveX plug-in for Internet Explorer 6		Microsoft Office 2003 Word file viewer
	Microsoft Remote Desktop Connection <sup>(1)</sup>		Microsoft Office 2003 Excel file viewer
	Microsoft media player 6.4 and 7.0 OCX		Westtek JETCET PDF viewer
	Microsoft WordPad text editor		

(1) The remote desktop connection is not currently supported on PanelView Plus 6 - 600 terminals with extended features.

## Windows Explorer

From the desktop, you can access Windows Explorer in several ways:

- Open the My Device icon on the desktop.
- Choose Start>Programs>Window Explorer.

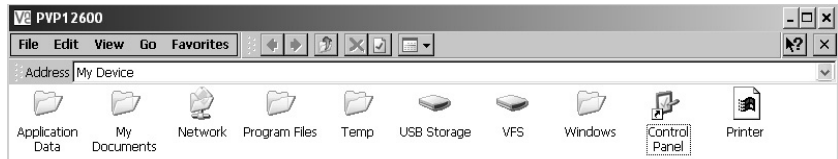

Besides the typical system folders, a few folders contain items specific to the PanelView Plus 6 terminals.

Folder	Content
Application Data	Contains FactoryTalk® View Machine Edition application files. Path: \Application Data\Rockwell Software\RSViewME
VFS (Virtual File System)	Contains firmware files and backup/restore files for the current system image. Path: \VFS\Platform Firmware

## Taskbar

The taskbar has icons to access the Start menu, terminal IP information, the current language and time, input panels, and open programs.

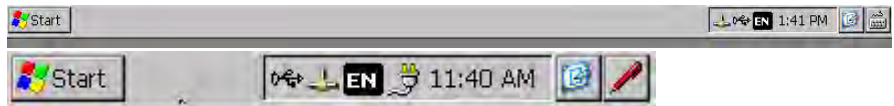

You can turn the taskbar on or off by choosing Start>Settings>Taskbar and Start Menu then checking or clearing the Auto Hide checkbox.

**TIP** On touch screen terminals, touch the bottom of the display to recover the taskbar in Auto Hide mode.

## Input Panels



Different soft keyboards or input panels are available for entering data. You can access these input panels from the taskbar:

- Keyboard and large keyboard
- CHT Chajei (Chinese)
- CHT Phonetic (Chinese)
- MS Kana (Japanese)
- MS Roma (Japanese)
- No IM - no input method selected (default)

**TIP** You can hide the view of an input panel from the taskbar by choosing the No IM option.

**TIP** On PanelView Plus 6 - 700 to 1500 terminals, you can also access the input panels from the control panel.

## Windows Control Panel

The Windows control panel is the desktop interface for configuring a terminal. You can set system-wide and terminal properties, such as network configuration, screen saver configuration, and touch screen calibration.

[Table 49](#) list the control panel applets. The language of the applets is based on the language set for the operating system. English is the default.

**TIP** Most terminal settings are available in FactoryTalk View ME Station.



You can access the control panel in several ways:

- Choose Start>Settings>Control Panel.
- Open My Device on the desktop, then open the Control Panel.

**TIP** Control panel dialogs on the 400/600 terminals have scroll bars for viewing.

**Table 49 - Availability of Control Panel Applets on Terminals**

Name	400/600	700 to 1500	Description
Accessibility	—	•	Adjusts your terminals settings for vision, hearing, and mobility.
Backup & Restore	•	•	Performs a backup and restore of an HMI terminal image.
Certificates	—	•	Manages digital certificates for establishing trust and secure communication.
Date and Time	— <sup>(2)</sup>	•	Sets the time, date, and time zone.
Dialing	—	•	Sets dialing patterns and location settings.
Display	•	•	Changes the wallpaper desktop appearances, backlight, screen saver, and visible cursor settings.
Error Reporting	—	•	Enables and configures software error reporting.
Hardware Monitor	•	•	Displays voltage and temperature information, and the system event log.
Input Panel	—	•	Configures the soft keyboard.
Internet Options <sup>(1)</sup>	•	•	Configures Internet Explorer settings.
Keyboard	— <sup>(2)</sup>	•	Configures an external USB keyboard.
Keypad	•	•	Configures the keypad on the terminal display (if one is present).
Logo Manager	•	•	Loads and applies a new image to the splash screen and screen saver on the HMI terminal.
Mouse	— <sup>(2)</sup>	•	Sets the USB mouse double-click properties.
Network and Dial-up Connections	•	•	Creates and configures direct, dial-up, VPN, and Ethernet connections.
Owner	—	•	Sets owner identification and security for device and remote network.
Password	—	•	Sets password and enables password protection for startup and Screen Saver mode.
PC Connection	—	•	Selects a connection between the device and a personal computer.
Printers	•	•	Adds and configures local and network printers.
Regional Settings	•	•	Selects the locale and sets the format of numbers, time, date, and currency.
Remove Programs	•	•	Uninstalls applications.
Server Config	•	•	Configures network servers: VNC, FTP, Web, File, KEPServer.
Services	•	•	Enables and disables services and servers.
Storage Manager	—	•	Reports information on storage devices. Scans, partitions, defragments, and mounts volumes.
System	•	•	Provides general system information. Sets and reports a device name and memory allocation/usage.
Terminal Server Clients <sup>(1)</sup>	—	•	Displays terminal server client access licenses for devices that connect to a terminal server.
Touch	•	•	Sets touch-screen properties, cursor, and calibrates touch screen (if one is present).
User Accounts	•	•	Manages user accounts for NTLM security.
Volume & Sound	—	•	Adjusts volume and sound properties for events, applications, and key clicks.

(1) Applies to PanelView Plus 6 terminals with extended features and file viewers.

(2) Settings for these properties are available in FactoryTalk View ME Station.

## Backup and Restore



The Backup and Restore application lets you back up the current system image on the HMI terminal, then restore that image to the same terminal, or clone it to other terminals. This function is intended for OEMs who want to back up a terminal image, then clone or copy that same image to multiple terminals.

A typical backup includes the following:

- File system
- Firmware image
- Windows registry

Additional user configuration data is included in the backup if you check Advanced Network & Display Settings.

**Table 50 - Advanced Network and Display Settings**

Network Parameters	Terminal Specific Parameter
Ethernet network	<ul style="list-style-type: none"> <li>• DHCP-enabled or fixed IP address with subnet mask and gateway</li> <li>• Primary and secondary DNS</li> <li>• Primary and secondary WNS</li> <li>• Speed and duplex settings</li> </ul>
USB network	USB IP address and subnet mask, Gateway, DHCP-enabled or fixed IP address
Network	Device name
Display	<ul style="list-style-type: none"> <li>• Display brightness</li> <li>• Screen saver dimmer timeout</li> </ul>

You can back up the terminal image to a file on a USB flash drive or SD card.

Follow these steps to perform a backup.

1. Insert a USB flash drive or SD memory card into the appropriate slot of the terminal.
2. In the control panel, double-click the Backup & Restore icon.
3. Click the browse ... button on the Backup tab.

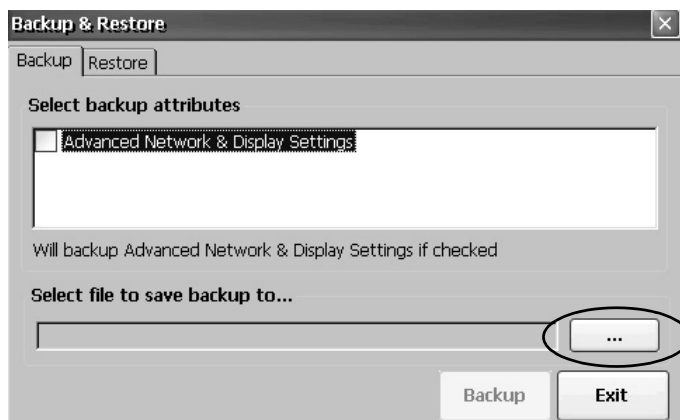

4. Select the location for the back-up file:
  - USB Storage if using a USB flash drive
  - Storage Card2 if using an SD card
  - Target folder if backing up to terminal
5. Type a name for the back-up file.  
All back-up files have the .pvb file type.
6. Click OK.

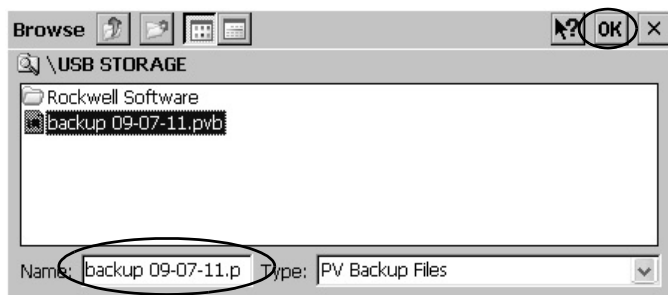



- Click Backup to start the process.

A progress bar shows the status of the backup.

The backup can take a few minutes. You receive notification when the backup completes successfully.



- Click OK.

If the file exists, you are asked if you want to overwrite the current file.

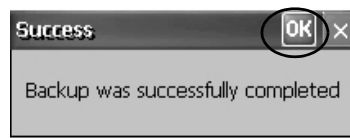

- Click Exit to close the Backup & Restore dialog box.

**TIP**

You can verify that .pvb file was successfully created by double-clicking My Device and selecting the target location for the backup.

Follow these steps to restore or clone a back-up image to a terminal from a USB flash drive or SD card.

- Insert the USB flash drive or SD memory card into the appropriate slot on the target terminal.
- In the control panel, double-click Backup & Restore.
- Click the Restore tab.
- Click the ... browse button to select the back-up file to restore.

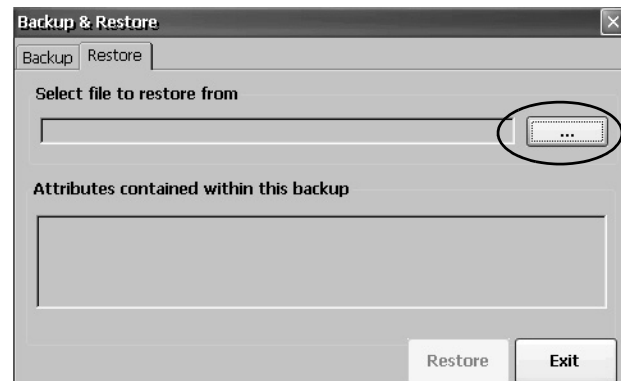

- Select the location of the back-up file:
  - USB Storage if using a USB flash drive
  - Storage Card2 if using an SD card
  - Target folder on terminal containing .pvb file

This example shows \USB Storage as the location.
- Select the .pvb back-up file to restore.
- Click OK.

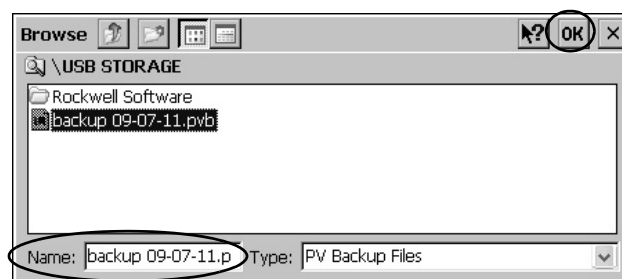

8. Click Restore.

The restore automatically includes advanced network and display settings if this option was checked when the backup was performed.



9. Click Yes to start the restore.

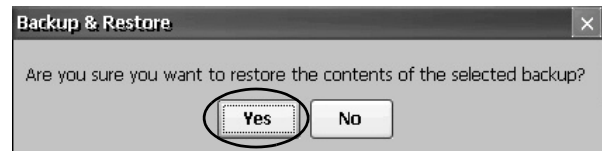

The terminal starts the restore process. This process can take a few minutes.

**IMPORTANT**

Do not remove the USB flash drive or SD card, or power off the terminal during the restore. This could corrupt the firmware.

If the restore fails, you need to reset the terminal from the maintenance menu.

Refer to [Access Maintenance Operations on page 170](#) for details.



When the restore has completed successfully, the terminal restarts.

## Hardware Monitor



The PanelView Hardware Monitor provides status and troubleshooting information for the terminals including running processes, system event log details, and monitoring of battery voltages, temperatures, and system usage, for example, CPU and memory loading.

### Processes

The Processes tab of the Hardware Monitor shows all processes currently running on the PanelView Plus 6 terminal and memory usage of each process.

ProcessName	ProcessId	Thr	BaseAddr	HeapSize	TotalMem	Commit	Reserved
NK.EXE	00400002	88	80225000	4169328	0	0	0
udevice.exe	01D20002	7	00010000	18400	2269184	1691648	577536
udevice.exe	01EC000A	1	00010000	2464	1814528	1630208	184320
udevice.exe	020F0002	1	00010000	4896	1814528	1630208	184320
udevice.exe	03020006	1	00010000	1536	1814528	1626112	188416
wt5portm.exe	0592000A	4	00010000	12160	2207744	1847296	360448
servicesd.exe	05F0000A	31	00010000	335088	5398528	2379776	3018752
RSLinxNG.exe	04FB001E	19	00010000	1292800	4907008	3211264	1695744
RSVCHost.exe	05EC00A2	13	00010000	108256	2789376	1900544	888832
udevice.exe	07660006	1	00010000	2560	1949696	1642496	307200
explorer.exe	07490596	6	00010000	51136	2691072	2019328	671744
fselect.exe	065A0696	1	00010000	2048	1818624	1630208	188416
CeVncServer.exe	04F10342	3	00010000	1132752	3252224	2838528	413696
control.exe	077B0092	1	00010000	22688	1818624	1667072	151552

Memory load 3766894592/320880640 [9%]

### System Event Log

The System Event Log tab of the PanelView Hardware Monitor displays warnings, errors, and events logged by the terminal.

Type	Date	Time	Category	MsgId	Message
Information	10/20/2010	12:36:19 AM	PVP	16777218	SYSMON: System boot. Reason: Normal
Information	10/20/2010	12:35:59 AM	None	65539	Microsoft (R) Windows CE (R) 6.00.0000
Information	10/20/2010	12:35:59 AM	None	65540	The Event log service was started.
Information	10/20/2010	12:23:58 AM	PVP	16777218	SYSMON: System boot. Reason: Normal
Information	10/20/2010	12:23:55 AM	PVP	16777218	SYSMON: Factory reset requested by
Information	10/20/2010	12:23:55 AM	PVP	16777218	SYSMON: NEW registry created by OS ver
Information	10/20/2010	12:21:57 AM	None	65539	Microsoft (R) Windows CE (R) 6.00.0000
Information	10/20/2010	12:21:57 AM	None	65540	The Event log service was started.

Cpu load 72%

The log provides a date and time stamp of when each event occurred and text describing the event. The maximum size of the log is 1 MB, approximately 4,000 records. If the log exceeds 1 MB, the oldest 512KB of information is removed:

- The Export Log button lets you export the event log to a CSV file (\*.csv) in the \Windows folder with the default file name, SystemLog.csv.
- The Clear Log button lets you clear all events from the log.
- The Details button lets you view more details for a selected event.

## Monitors

The Monitors tab of the PanelView Hardware Monitor provides continuous voltage, temperature, and load information for the terminal.

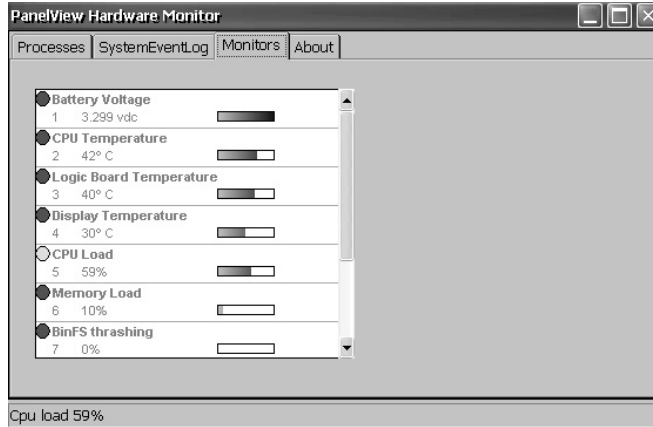

### Battery Voltage

The Monitors tab gives a visual status and voltage reading of the battery for the real-time clock. The battery voltage is updated at powerup and then every hour.

**Table 51 - Battery Conditions**

Condition	Logic Module Battery
Depleted	Less than 2.0V indicates a dead battery or no power.
Low	2.0...2.74V
Normal	2.75V or higher

### Temperatures

The Monitors tab provides a visual status and current temperature of the CPU, logic board, and terminal display. The temperature is updated every 10 seconds.

**Table 52 - Temperature Conditions**

Condition	Logic Board	CPU <sup>(1)</sup>	Display <sup>(1)</sup>
Low	—	—	10 °C (50 °F) or lower
Normal	25...94 °C (77...201 °F)	25...94 °C (77...201 °F)	11...59 °C (52...138 °F)
High	95 °C (203 °F) and higher	95 °C (203 °F) and higher	60 °C (140 °F) and higher

(1) The CPU and display temperatures do not apply to the 400 and 600 terminals.

## Keypad Properties



Use the Keypad and Keyboard dialog boxes to adjust settings for the membrane keypad of your terminal or an attached USB keyboard. The Keyboard applet is always present. The Keypad applet appears only if your device has a keypad. If you attach two USB keyboards, settings are used that work with both keyboards.

### Repeat Tab

The Repeat tab on the Keypad or Keyboard Properties dialog box controls the character repeat behavior of keys on the keypad or attached keyboard.

When character repeat is enabled, you can set the repeat delay and repeat rate of keys. Verify your settings by pressing a key in the test edit box.

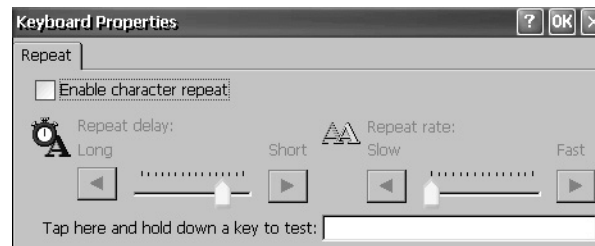

## Touch Properties



Touch Properties is accessible only on devices with a touch screen. It lets you calibrate the touch screen and set the sensitivity of touch screen taps.

### Calibration

The Calibration tab lets you recalibrate the touch screen if your device is not responding appropriately to taps. Follow the instructions in the dialog box to recalibrate.

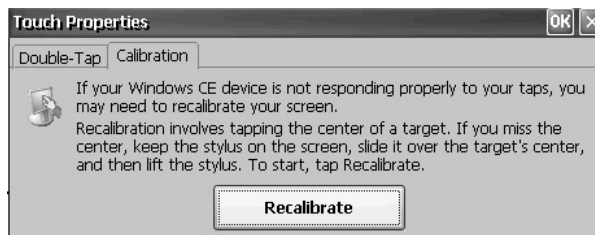

### Double-Tap

The Double-Tap tab on the Touch Properties dialog box lets you set and test the double-tap sensitivity of the touch screen taps.

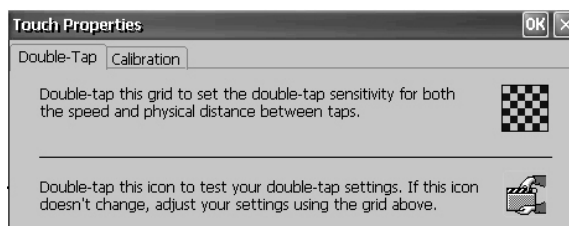

## Display Properties



Use Display Properties to control the desktop background image and appearance, the brightness of the backlight, and screen saver settings.

### Desktop Background

The Background tab in Display Properties controls the background bitmap on the desktop. The default bitmap is abclocknight.

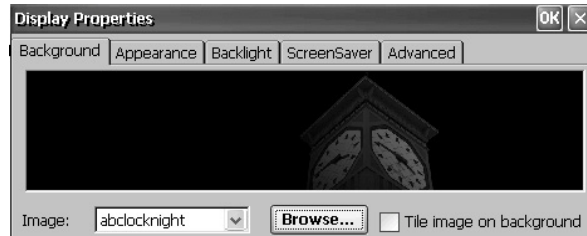

You can select another image from the pull-down menu or browse the system for a bitmap image. Custom images are in the \Windows folder.

### Desktop Appearance

The Appearance tab in Display Properties controls the visual style and colors of the desktop and other window elements.

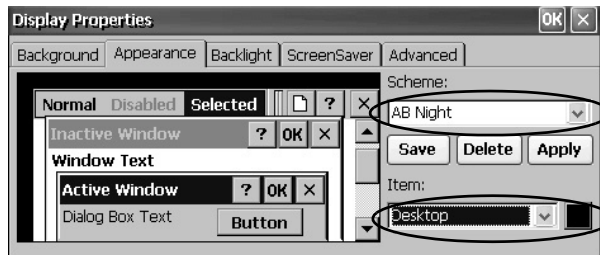

Two custom schemes and images are provided for day or night viewing. When changing schemes, remember to also change the image on the Background tab.

Scheme	Desktop Color	Background Logo
AB Day	Blue	abclocknight
AB Night	Black	abclockday

### Backlight Intensity

The Backlight tab in Display Properties lets you set the brightness level of the display between 1...100%. At 1%, the display is minimally visible.

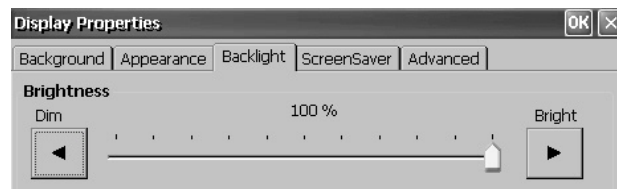

When the backlight is in Overdrive mode, the brightness cannot be adjusted. Refer to [View the Display Temperature on page 65](#) for more details.

## Screen Saver

The screen saver extends the lifetime of the display by dimming the backlight when the terminal is idle. The screen saver activates and displays a moving bitmap at a reduced brightness level after a continuous idle time. When the screen saver is deactivated, the display brightness returns to its normal level.

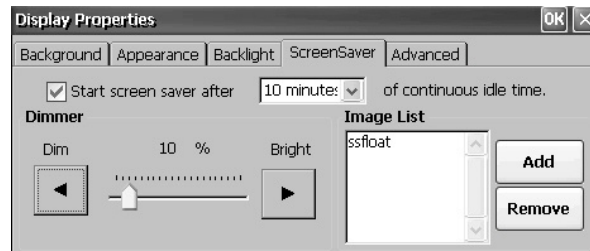

The Screen Saver tab in Display Properties lets you perform these operations:

- Enable the screen saver by using a specified idle timeout. The default idle time is 10 minutes.

When the screen saver is activated, the dimmer controls the backlight intensity level. You set the brightness level of the dimmer in the range 0...100%. The default dimmer intensity is 10%. At 0%, the backlight is off and the display is dark.

- Browse the system for a bitmap to be displayed by the screen saver at a nonzero brightness level. The default screen saver is SSFloat.bmp. Click Add or Remove to change the screen saver bitmap. The system recognizes bitmaps stored in the \Windows folder.
- Disable the screen saver by clearing the Start screen saver checkbox.

## Cursor, Rotation, and Color Depth

The Advanced tab in Display Properties lets you perform these operations:

- Enable or disable the visible cursor that you see on the display. The cursor is visible by default.
- Rotate the screen on the terminal. The default is 0 degrees.
- Specify the color depth of the display. The default is 32 bits per pixel (bpp).

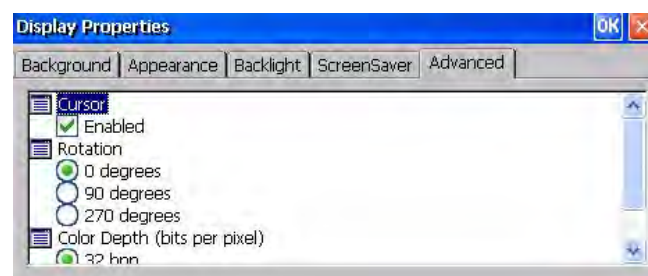

## Logo Manager



Use the Logo Manager to change the logo that appears on the splash screen at startup and the default screen saver image. The default image is the Allen-Bradley logo (ablogo.bmp).

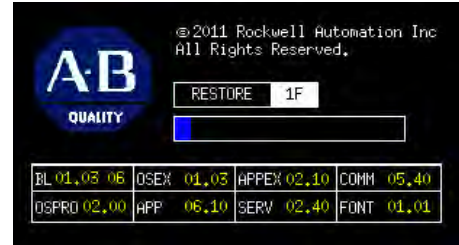

The logo can be a .bmp, .jpg, .gif, or .png image. For best results, it is recommended that the logo be created as a 90 x 90 pixel, 16-bit color image.

Before applying the new logo, you can do the following:

- Preview the logo on the splash screen.
- Resize the image to fit the fixed area on the splash screen.

Follow these steps to apply a new logo to the splash screen and screen saver.

1. Double-click the Logo Manager icon.

The Logo Manager opens with the current logo.

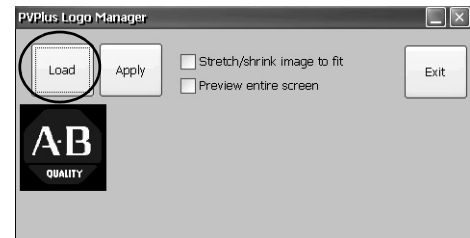

2. Click Load.

3. Select the location of the new image you want to load:

- A folder
- Storage Card2 - SD card
- USB Storage - USB drive

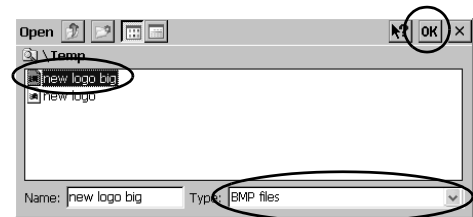

4. Select the image file to load.
5. Verify the file type is correct.
6. Click OK.

The new logo appears in the Logo Manager dialog box.

7. Check 'Preview entire screen' to view the logo on the splash screen.

If the logo is truncated or too small, check 'Stretch/shrink image to fit' to resize the logo to fit in the area.

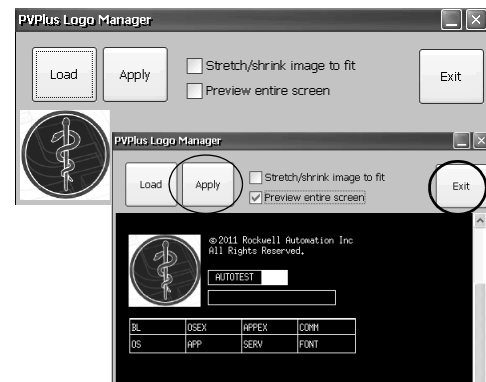

8. If satisfied with the preview, click Apply.

A dialog box confirms the splash screen was successfully updated. The default screen saver, sfloat.bmp, is also updated with the new image.

9. Click OK, then click Exit to close the Logo Manager.



## System Information

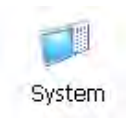

The System Information dialog provides tabs to let you view and set system-wide properties for your terminal.

### General Information

The General tab of the System Information dialog box shows the current version of the Windows CE operating system, the processor type and speed, and RAM memory on terminal.



### Startup Options

The Startup Options tab in the System Information dialog box lets you set these options at startup:

- Show or hide battery warning
- Launch the platform as open or closed system
- Disable or enable Safe mode request
- Show or hide system watchdog errors



### Battery Warnings

If the battery is low, missing, or dead, a warning displays each time the terminal starts up.

- TIP**
- The terminal can be operated without a battery if it is not required that the time and date be accurate.
  - When replacing the battery, you can verify the accuracy of the system date and time from the control panel or the terminal settings in FactoryTalk View ME Station Configuration mode.



You have three options for handling the battery warning.

Battery Warning Start-up Options	Description
Always show at startup (continue with startup)	Shows the battery warning at startup with FactoryTalk View ME Station software running behind it. This is the default.
Always show at startup (halt startup)	Shows the battery warning at startup but halts the startup or boot process until you press OK.
Never show at startup	Hides the battery warning at startup.

### Shell Options

Use the Shell options to launch an open or closed desktop at startup or to set the visual appearance of button controls.



Shell Startup Options	Description
System Type	<p>Launches the terminal as an open or closed system at startup:</p> <ul style="list-style-type: none"> <li>Open - launches the Windows CE desktop on startup.</li> <li>Closed (default) - launches FactoryTalk View ME Station Configuration mode on startup.</li> </ul> <p>You can also allow or restrict desktop access within FactoryTalk View ME Station Configuration mode by pressing Terminal Settings&gt;Desktop Access Setup. Refer to <a href="#">Desktop Access on page 52</a>.</p>
User Interface Button Controls	<p>Sets the visual appearance of control buttons at startup:</p> <ul style="list-style-type: none"> <li>Windows XP Style (default)</li> <li>Windows 95 Style</li> </ul>

### Boot Option

The boot option provides a way for you to enter Safe mode at startup.



Safe Mode Option	Description
Do not detect Safe mode request at startup	Disables Safe mode detection during startup. This is the default.
Detect Safe mode request at startup	<p>Displays a small white box in the lower left corner of the terminal display during startup that you can touch or press F1 to enter Safe mode. This lets you bypass a loaded FactoryTalk View ME application and go directly to Configuration mode. If you don't press F1 or touch the white box, the system boots up normally.</p> <p>Another way to enter Safe mode is to access Maintenance mode. Refer to <a href="#">Access Maintenance Operations on page 170</a>.</p>

## Watchdog Errors

You can show or hide watchdog errors at startup.



Watchdog Error Options	Description
Always show watchdog errors at startup	Shows the fatal watchdog error (error 02) at startup and halts the normal boot process. This is the default. The system launches the maintenance window with the watchdog error displayed. You can continue booting from this window. Refer to <a href="#">Access Maintenance Operations on page 170</a> for details. The error is logged to the System Event log.
Never show watchdog errors at startup	Hides the errors at startup and logs the error to the system event log.

## Advanced Diagnostics

Advanced diagnostics are for technical support use to diagnose and resolve system errors. They are not for use in a normal production environment.



## Device Name

The Device Name tab of the System Information dialog box identifies your terminal to other devices on the network by providing a device name and description.

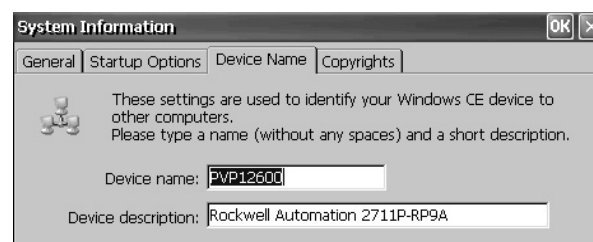

**TIP** Duplicate names conflict and cause network problems.