

REF542plus

Multifunction Protection and Switchgear Control Unit

Operator's manual



Contents

1. Introduction.....	7
1.1. This manual.....	7
1.2. Use of symbols.....	7
1.3. Intended audience.....	8
1.4. Product documentation.....	8
1.5. Revision history.....	8
2. Safety information.....	9
3. HMI features.....	11
3.1. Control area.....	11
3.2. Info and Menu area.....	13
3.3. REF542plus status information area.....	15
4. Behavior at power up.....	17
5. Control modes.....	19
5.1. Available control modes.....	19
5.2. Changing the control modes.....	19
6. Operating the primary objects.....	21
7. Viewing and resetting alarms.....	23
7.1. Viewing alarms.....	23
7.2. Resetting alarms.....	23
8. Viewing measurements.....	25
9. Viewing events.....	27
10. Viewing and changing the protection settings.....	29
10.1. Viewing the protection settings.....	29
10.2. Changing the protection settings.....	29
10.2.1. Changing the protection key mode.....	29
10.2.2. Changing the protection parameters.....	30
10.2.3. Changing the active parameter set.....	32
10.2.4. Viewing and changing control parameters.....	33
11. Setting the time and date.....	35
12. Command page.....	37
13. REF542plus commissioning mode.....	39
13.1. Binary input commissioning page.....	40
13.2. Binary output commissioning page.....	41
13.3. Analog input commissioning page.....	42
13.4. Analog output 4- 20 mA commissioning page.....	44
13.5. Analog input 4-20 mA commissioning page.....	46
13.6. Optical inputs commissioning page.....	47

- 13.7. Optical output commissioning page..... 47
- 14. Connection to PC..... 49**
 - 14.1. Optical to RS232 converter cable..... 49
 - 14.2. Downloading a configuration..... 49
 - 14.2.1. Serial port settings..... 50
 - 14.3. Uploading the configuration..... 52
 - 14.4. Uploading other information..... 53
- 15. Troubleshooting..... 55**
 - 15.1. Error messages..... 55
 - 15.2. Clearing the configuration inside the unit..... 60
 - 15.3. Primary objects incorrect visualization..... 60
- 16. Terminology..... 63**
- 17. Abbreviations..... 65**
- 18. Appendix A: Connection diagrams..... 67**
 - 18.1. Analog Inputs..... 69
 - 18.2. Binary inputs and outputs..... 72
 - 18.2.1. Static..... 72
 - 18.2.2. Electromechanical..... 73
 - 18.2.2.1. BIO3..... 73
 - 18.3. Other connections..... 75
 - 18.3.1. Analog outputs 0/4-20 mA..... 75
 - 18.3.2. Analog inputs 4-20 mA..... 75
 - 18.3.3. Communication module..... 76
 - 18.3.4. Power supply..... 76
 - 18.3.5. Time synchronization..... 77
 - 18.3.6. HMI..... 77
- 19. Appendix B: Menu structure..... 79**
 - 19.1. Reset page..... 80
 - 19.2. Service page..... 82
 - 19.3. Test page..... 98
 - 19.3.1. Test HMI..... 98
 - 19.3.2. Test primary object..... 99
- 20. Appendix C: Tripping time indication..... 101**

Copyrights

The information in this document is subject to change without notice and should not be construed as a commitment by ABB Oy. ABB Oy assumes no responsibility for any errors that may appear in this document.

In no event shall ABB Oy be liable for direct, indirect, special, incidental or consequential damages of any nature or kind arising from the use of this document, nor shall ABB Oy be liable for incidental or consequential damages arising from use of any software or hardware described in this document.

This document and parts thereof must not be reproduced or copied without written permission from ABB Oy, and the contents thereof must not be imparted to a third party nor used for any unauthorized purpose.

The software or hardware described in this document is furnished under a license and may be used, copied, or disclosed only in accordance with the terms of such license.

Copyright © 2006 ABB Oy

All rights reserved.

Trademarks

ABB is a registered trademark of ABB Group. All other brand or product names mentioned in this document may be trademarks or registered trademarks of their respective holders.

Guarantee

Please inquire about the terms of guarantee from your nearest ABB representative.

1. Introduction

1.1. This manual

Before attempting any operation with REF542plus, read this manual carefully first.

This manual describes how to use the interface of REF542plus (LD HMI, Local Detached Human Machine Interface). Note that HMI views and pictures are to be considered exemplary.



Do not make any changes to the REF542plus configuration unless you are authorized to do it and familiar with REF542plus and its Operating Tool. This might result in malfunction and loss of warranty.

1.2. Use of symbols

This publication includes the following icons that point out safety-related conditions or other important information:



The electrical warning icon indicates the presence of a hazard which could result in electrical shock.



The warning icon indicates the presence of a hazard which could result in personal injury.



The caution icon indicates important information or warning related to the concept discussed in the text. It might indicate the presence of a hazard which could result in corruption of software or damage to equipment or property.



The information icon alerts the reader to relevant facts and conditions.

It should be understood that operation of damaged equipment could, under certain operational conditions, result in degraded process performance leading to information or property loss. Therefore, comply fully with all notices.

1.3. Intended audience

This manual is intended for operators, supervisors and administrators to support normal use of the product.

1.4. Product documentation

Name of the Manual	Document ID
Application Notes	1MRS755870
CAN Manual	1VTA100189-Rev 1, en
Configuration Manual	1MRS755871
iButton Programmer User Manual	1MRS755863
Manual Part 3, Installation and Commission	1 VTA100004
Manual Part 4, Communication	1VTA100005
Motor Protection with ATEX Certification, Manual	1MRS755862
Operator's Manual	1MRS755869
Protection Manual	1MRS755860
Technical Catalogue	1MRS755859
Technical Reference Modbus RTU	1MRS755868
Web Manual, Installation	1MRS755865
Web Manual, Operation	1MRS755864

1.5. Revision history

Version	Date	History
1VTA100172-Rev 1, en	01.11.2002	First release
1VTA100172-Rev 2, en	22.10.2003	Updated to version 4D02
1VTA100172-Rev 3, en	03.05.2004	Updated
1VTA100172-Rev 4, en	04.04.2005	Updated
A	28.02..2006	Document updated <ul style="list-style-type: none"> • language • layout

Applicability

This manual is applicable to REF542plus Release 2.0, software version V4D02.

2. Safety information



Dangerous voltages can occur on the connectors, even though the auxiliary voltage has been disconnected.

Non-observance can result in death, personal injury or substantial property damage.

Only a competent electrician is allowed to carry out the electrical installation.

National and local electrical safety regulations must always be followed.

The frame of the device has to be carefully earthed.



The device contains components which are sensitive to electrostatic discharge. Unnecessary touching of electronic components must therefore be avoided.

3. HMI features

The REF542plus HMI is shown in Fig. 3.-1. The HMI features a back illuminated LCD, 8 push buttons, several LEDs and an electronic key sensor. The language of the display, when available, can be selected via the Operating Tool. The default language is English.

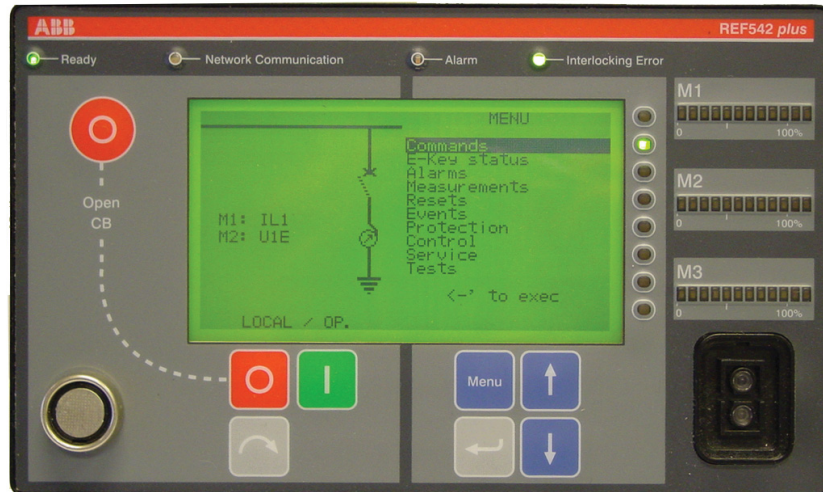

A051327

Fig. 3.-1 REF542plus HMI

The LCD in the SLD view provides a graphical representation of the primary objects controlled or monitored by REF542plus in the switchgear. The right half of the LCD is for plain text visualization such as measurements and protection events. The contrast level is automatically controlled for an optimum reading, it can also be adjusted as wanted.

The HMI panel is organized in three main areas.

3.1. Control area

The left side of the HMI panel is for primary objects control. The command buttons and the information related to the switchgear control are placed on this area



A051328





Fig. 3.1.-1 HMI control area

1 E-Key sensor

This section of the LCD display shows the Single Line Diagram (SLD) of the controlled panel and the measurement bars. Text can be added in this section to improve the understanding of SLD.

- Command buttons

The Primary Object Control can be performed with the following push buttons to allow operating the primary objects if configured as “selectable”. The command push buttons for local operation of the switching devices are:

-  Open: to open the selected object.
-  Close: to close the selected object.
-  Select: to select the object. The selected object appears highlighted.
-  CB Fast Opening: to allow opening of the circuit breaker independently from the selected control mode. When pressed simultaneously with the normal open button, this button allows opening the circuit breaker independently from the selected control mode. This feature must be enabled in the unit with the Operating Tool.

- E-Keys Sensor: this is the sensor for the electronic keys. The sensor automatically detects which key has been inserted. The two keys are usually labelled “Protect” and “Control” to distinguish them.
- Protection key: is specialized to the protection environment allowing changing of parameters and other functions related to the protection.
- Control Key: this is dedicated to the control modes. It allows changing the operating mode of REF542plus. The different operating modes discipline the access to the primary objects by the different REF542plus interfaces (HMI and SCADA). When required, a Super User key to access both

modes can be provided. The Super User key is also needed to access the commissioning test mode. The password codes stored in the key can be customized in each REF542plus for access restriction purposes.

- SLD view: this is the graphical part of the LCD. This part shows the single line diagram of the switchgear. The status of the primary objects is dynamically updated after every operation. If for example the circuit breaker has been opened, its representation will reflect it.

3.2. Info and Menu area

The right side of the HMI LCD is for information and menu browsing. The buttons to navigate through the menus and to change items are placed on this area.



A051333

Fig. 3.2.-1 Info and Menu area

- Menu Navigation: these push buttons allow navigation trough the REF542plus menus.



Pressing this button, the unit goes back to the former menu.



The up direction push button.



The down direction push button.



The enter push button to enter into the selected menu or to select the highlighted submenu.

The following menus are available in the main window:

- Commands: this menu shows the configured FUPLA commands.
- E-Key status: to display and change the unit modes with the electronic keys.
- Alarms: it displays the indication LED's status.

- Measurements: it displays the available measurements.
- Resets: to acknowledge alarms and other quantities.
- Events: to display protection starts and trips events.
- Protection: it displays the protection functions installed in the unit, and allows displaying and changing their settings.
- Control: it displays the control functions list installed in the unit and allows displaying and changing their settings.
- Service: relevant information on the HW and SW configurations and basic setting of REF542plus.
- Tests: to access the test mode for the HMI and the primary objects.



Access to a few submenus is allowed only in some modes.

- LED bars: The three LED bars are available to show the most relevant measurements acquired by REF542plus for a quick inspection of the switchgear load situation. The three bars are marked M1, M2, and M3. Each bar is composed of twelve LEDs, ten green and two red ones. The ten green LEDs are normally dedicated to display between 0% and 100% of the nominal value of the configured measurement. Each LED corresponding then to 10% of the nominal value. The two red LEDs indicate an overload condition of 20%. The measurements displayed by the bars are set with the Operating Tool.
- Indication LEDs: 8 freely programmable, three-color LEDs are available for indications. There are 4 pages of these LEDs. As a result, a total of 32 indication options can be programmed for events and status regarding protection, control, monitoring, binary inputs and so on. The assignment of the LED to a specific condition is done with the Operating Tool.
- Optical interface: This is the optical serial interface port to connect REF542plus to a personal computer. By using the appropriate cable and the Operating Tool, the following actions are possible:
 - Download a configuration into the unit.
 - Upload the current configuration from the unit.
 - After a fault, upload the fault recorder data. This is possible only if the fault recorder has been previously enabled with the Operating Tool.

Upload other information (measurements, binary inputs status, binary output status).



Do not make any changes to the REF542plus configuration unless you are familiar with REF542plus and the Operating Tool. This might result in malfunction and loss of warranty.

3.3.

REF542plus status information area

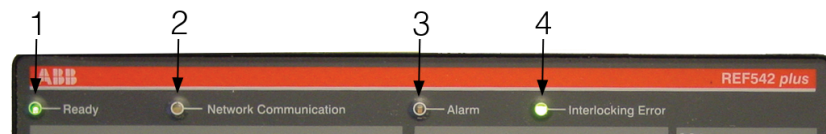

A051338

Fig. 3.3.-1 Status Information area

- 1 Unit status
- 2 Network Communication status
- 3 Alarm
- 4 Interlocking Error

The HMI shows the following status information:

- Ready. This green LED is turned on when the unit is in the operational state. The LED is switched off when the auxiliary power is not present or when the unit is not operational (FUPLA is not running).
- Network Communication. This LED is meaningful only when the REF542plus is equipped with a communication module. When a communication module is detected the LED turns on to green. If the module is not detected or fails, the LED turns red. When a Modbus communication module is installed, the LED becomes orange if the communication error rate increases. It becomes red when the communication error rate prevents good communication. The LED comes back to green when no communication errors occur or by resetting the module status registers (see the Modbus technical reference). When there is no communication module, the LED is always switched off.
- Alarm: this LED turns to red when the user defined alarms become true. Several arbitrary alarm conditions can be defined and configured with the Operating Tool. Alarm conditions could be the trip of a protection function, loss of SF6 in the circuit breaker and so on. When this LED is on, it is not possible to close the circuit breaker or to download a new configuration. The alarm must be acknowledged first.
- Interlocking Error: this LED is usually green. It turns temporarily to red when the user attempts an operation that would violate the programmed interlocking conditions; for example switching a disconnector with the circuit breaker in closed position.

4. Behavior at power up



Before energizing the switchgear, verify that the REF542plus protection functions are properly set and that the unit is properly working (READY LED green).

At power up, the HMI unit shows on the LCD for a few seconds the following:

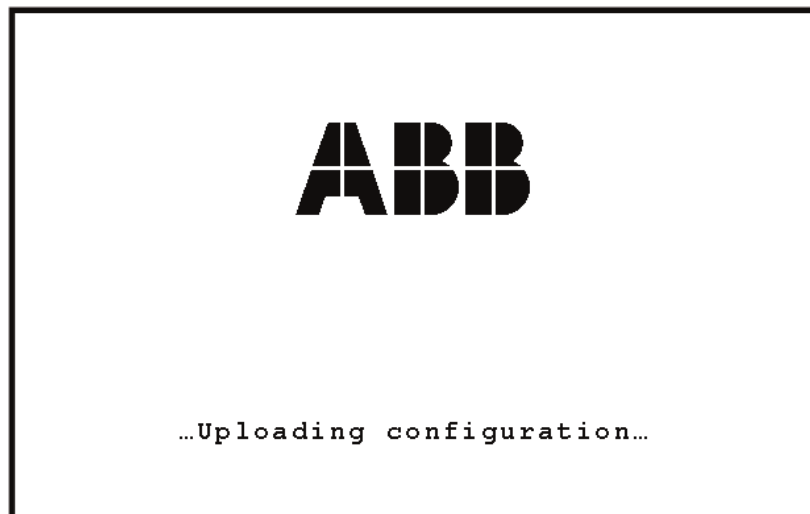

A051339

Fig. 4.-1 REF542plus LCD during power up

After that, the LCD left part shows the switchgear single diagram while the right part shows the default menu. When the initialization is completed and the unit is operational, the ready LED is on.

5. Control modes

5.1. Available control modes

Local Control

It is possible to control the circuit breaker and other primary objects from the HMI using the object control buttons. Open and close operations are possible only if the interlocking logic programmed into the unit allow them. Remote control from the SCADA is inhibited. Uploading and downloading the configuration via the optical interface is possible.

Remote Control

The control of the circuit breaker and other primary objects from the HMI is inhibited. The control is possible only remotely. Uploading and downloading the configuration via the optical interface is possible.

No Control

It is not possible to control the circuit breaker and other primary objects both from the HMI and remotely. Any kind of operation apart from the protection trip is inhibited. Uploading and downloading the configuration via the optical interface is possible.

Local and Remote Control





Both the local control and remote control from HMI are possible. Uploading and downloading the configuration via the optical interface is possible.



The selection of this control mode requires caution, because operations are allowed both from the HMI and remotely.

5.2. Changing the control modes

The next figure shows how to change the control mode. At first the menu E-Key must be selected. Then the control key must be placed in the electronic key sensor.

Select then the desired control mode by using UP  and DOWN  until it is highlighted. Confirm the selection by pressing ENTER . After pressing ENTER , the E-key status menu will appear again. Verify that the required control mode has been properly set in the unit looking in the lower left corner of the HMI. A text string there indicates the currently selected control and protection mode.

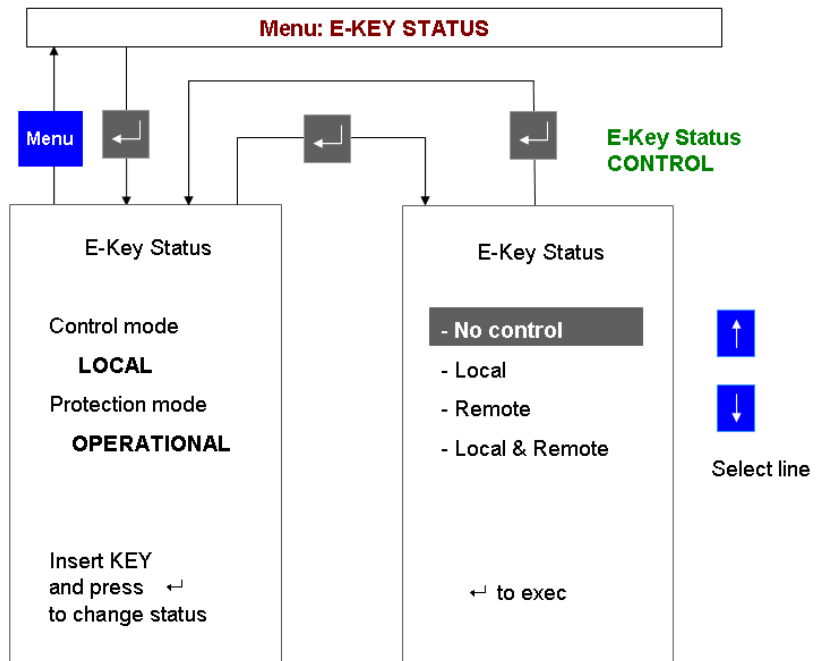



A051340

Fig. 5.2.-1 Changing the control mode by using the control key

6. Operating the primary objects

The primary objects can be operated from the HMI when the selected control mode is local or local and remote. The Object control push buttons allow operating the primary objects.

Press  to step through the available objects until the desired object is selected (it will appear highlighted in the SLD). The object remains highlighted until the open or close push button is pressed or the time-out has elapsed.

Press  to open the selected object.

Press  to close the selected object.



Only primary objects controlled directly by REF542plus can be selected. For example, REF542plus will show the correct position of a manual disconnect switch after an operation, but it will not be possible to select it.

7. Viewing and resetting alarms

7.1. Viewing alarms

The presence of an alarm, when latched, is indicated by the alarm LED turned on or by one of the 8 x 4 pages user programmable LED's turned on to red. The conditions or the events that generate an alarm are defined and programmed with the Operating Tool.

When an alarm is active, the corresponding LED is turned on to red. Select the alarm menu with the navigation buttons. Then, this menu displays the text associated to the alarm condition. The displayed text is defined with the Operating Tool.

There are four pages of alarms and each page reports eight alarms at most. Use the navigation button to browse through the pages.

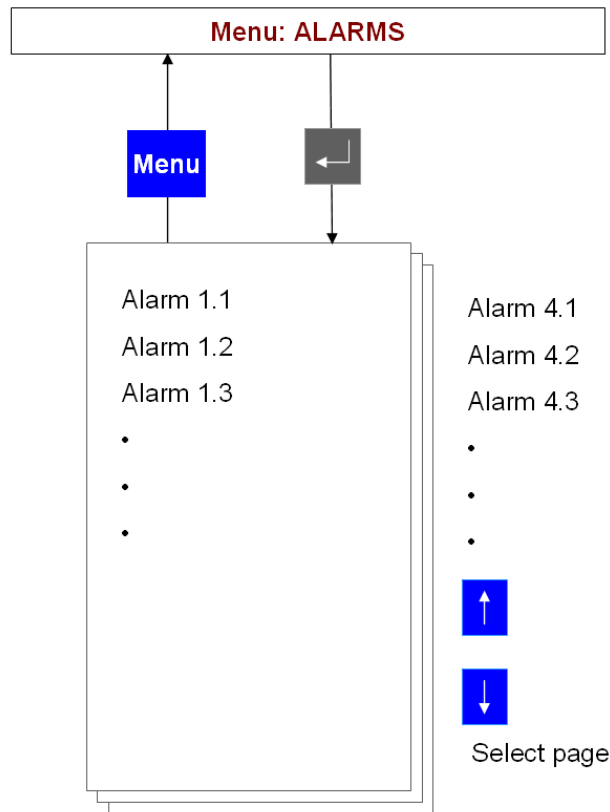



A051341

Fig. 7.1.-1 Alarm visualization

7.2. Resetting alarms

At first, the reset menu must be selected. Select the reset menu with the navigation buttons. Highlight the reset alarm line in the menu and then press ENTER .

8. Viewing measurements

REF542plus offers complete measurements set to the user. To view the measurements, select the measurement menu with the navigation button. Use the UP  and DOWN  buttons to browse the measurement pages.

The available measurements depend upon the unit configuration. In the maximum configuration, the following measurements are displayed:

- IL1, IL2, IL3, in A; line currents, measured values
- U1E, U2E, U3E, in kV; phase to earth voltages, measured values
- UL12, UL23, UL31, in kV; phase-to-phase voltages, computed values.¹⁾
- IL1 mean, IL2 mean, IL3 mean, in A; mean currents in the observation period, computed values
- IL1 max, IL2 max, IL3 max, in A; maximum peak currents in the observation period, computed values
- Frequency, in Hz; measured values
- Active power, in kW; reactive power in kVAr, apparent power in kVA, computed values
- Power factor, computed value
- Active energy in MWh, reactive energy in Mvarh; computed values
- Operating hours, in hours. This is the total working hours of the unit
- Switch cycle, number the circuit breaker close-open cycles
- Added switched current, in kA; sum of the interrupted currents by the circuit breaker
- THD (total harmonic distortion)



The observation period is set with the Operating Tool. It can be from 0 minutes up to 30 minutes. If the observation period is set to 0, the corresponding measurements are disabled.

The refresh time for the displayed measurements is about half second.

¹⁾ REF542plus can also use phase-to-phase voltage transformers. When used, phase-to-phase voltages are measured and phase to earth voltages are computed.

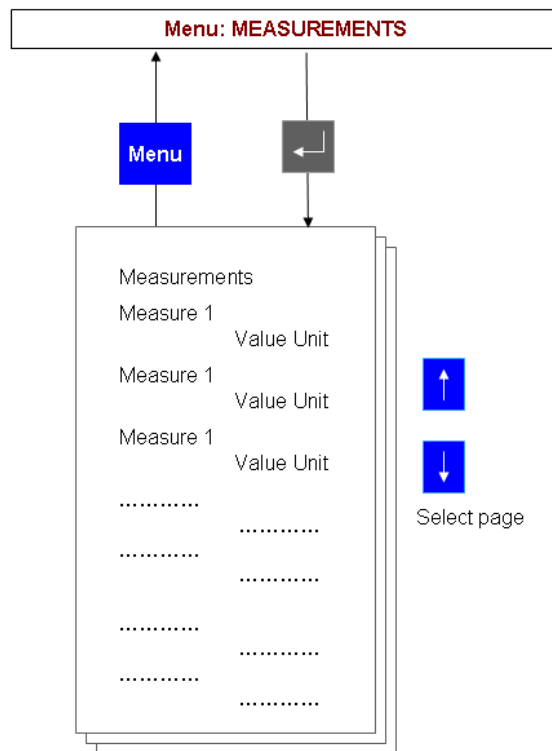

A051343

Fig. 8.-1 Measurements visualization



The available measurements depend upon the analogue input module type and the unit configuration.

9. Viewing events

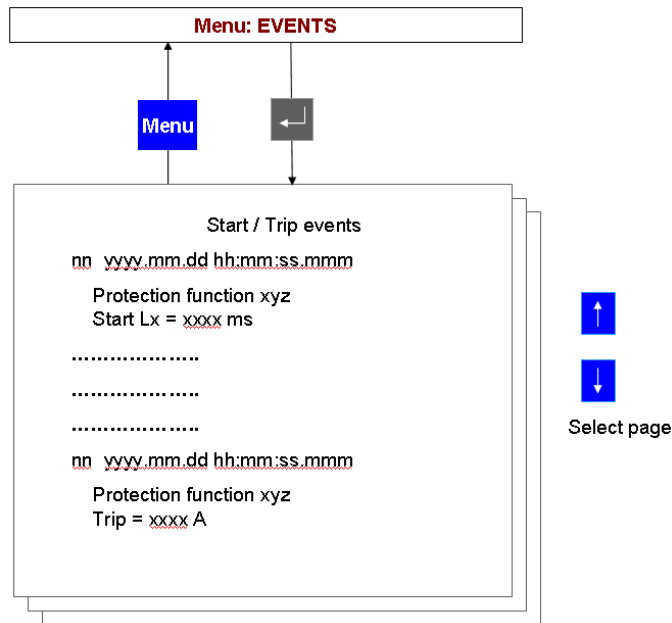

REF542plus records the last 30 protection events (start, trips, block and other). This internal memory is managed as a circular buffer, for example the 31st event overwrites the 1st oldest one. In case of a power loss, events are kept because they are stored in the non-volatile memory.

For each event, the following information is recorded: involved protection function, event type, relevant measurement (current, voltage, frequency), date and time (up to milliseconds). Events are displayed using the full screen; the single line diagram is thus not visible.



A051344

Fig. 9.-1 Events display

To display the protection events, select the **Start/Trip** menu with the navigation buttons. Use UP  and DOWN  to browse through the events.

10. Viewing and changing the protection settings

10.1. Viewing the protection settings

The protection functions currently installed in the unit can be seen in the menu protection functions. Select the menu protection functions with the navigation push buttons.

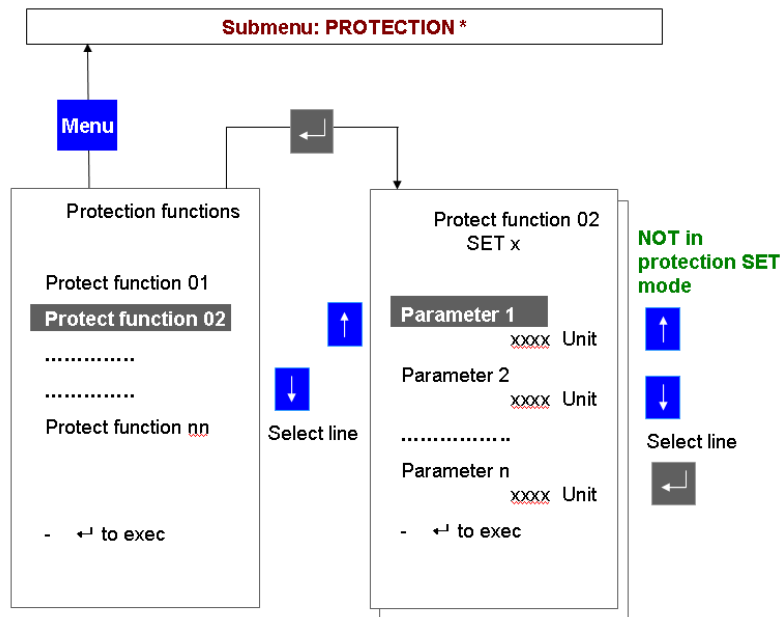

A051345

Fig. 10.1.-1 Viewing the installed protection functions

Use UP and DOWN to highlight the desired protection function and press ENTER . Then, the protection parameters will be displayed in one or more pages.

10.2. Changing the protection settings





10.2.1. Changing the protection key mode

Two different modes are available for the protection functions:

- Set: It is possible both to visualize and to change the protection settings.
- Operational: It is possible to visualize the protection settings but it is not possible to modify them.

In both modes, the protection functions are active.

In the operational mode, parameterization of the protection functions is also possible by a SCADA when present. In the set mode, parameterization from a SCADA is inhibited.

The procedure to change the protection mode is identical to changing the control mode. At first, the menu **E-Key** must be selected. Then the protection key must be placed in the electronic key sensor. Select then the required protection mode by using UP  and DOWN  until it is highlighted. Confirm the selection by pressing ENTER . After having pressed ENTER  push button, the **E-key status menu** will appear again. Verify that the required protection mode has been properly set in the unit, looking in the HMI lower left corner.

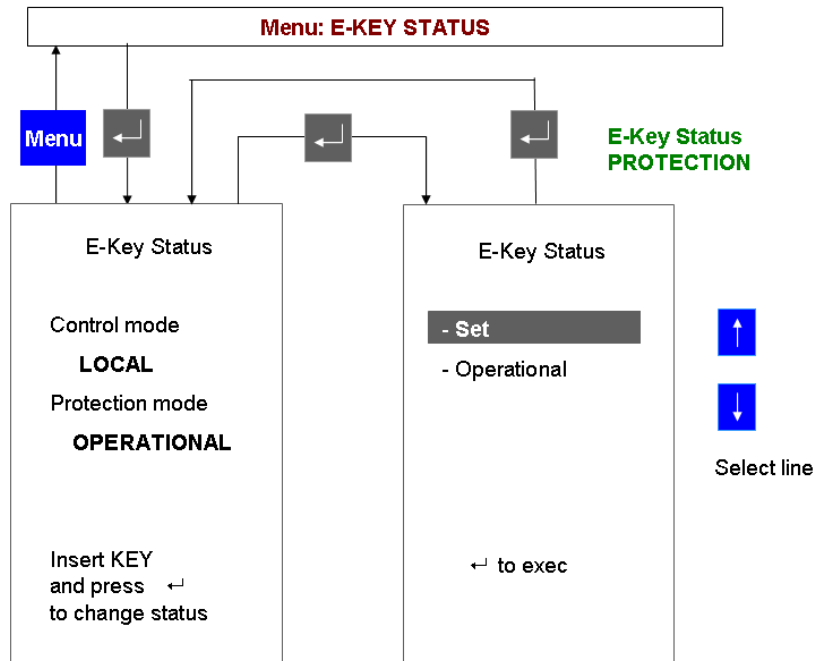









A051346

Fig. 10.2.1.-1 Changing the protection mode by using the protection key

10.2.2.

Changing the protection parameters

Select the menu protection functions with the navigation push buttons and highlight the desired protection function. Press ENTER  to select it. Press ENTER  again and the cursor will automatically go to the first parameter. Use Up  or Down  buttons to modify the parameter as wished. After completed, press ENTER  and use Up  and Down  button to select the next parameter to change.

Repeat the procedure for all the parameters that need to be modified. Then press  to go back to the list of currently installed protection functions. Repeat the procedure for every protection function that needs to have the setting modified.

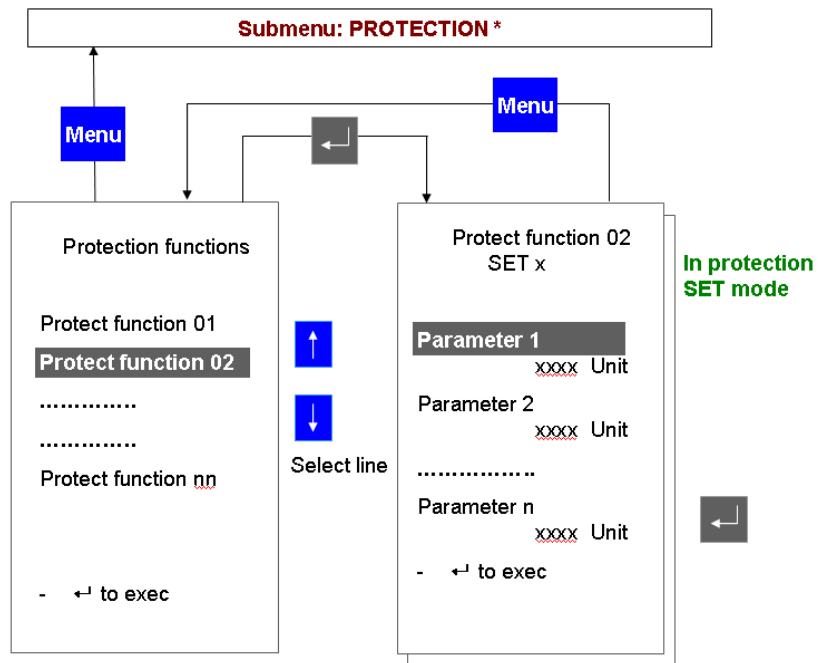

A051347

Fig. 10.2.2.-1 Changing protection parameters

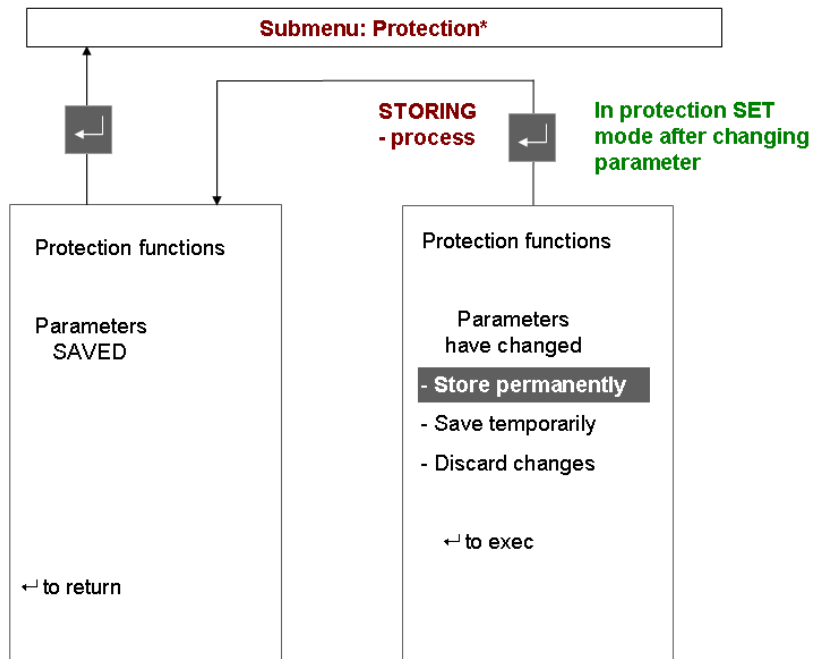

Press **Menu** again to leave the protection functions menu. The unit will then ask what to do with the changes:

The following screen will appear:



A051348

Fig. 10.2.2.-2 Unit right screen after protection parameters modification

Select the desired choice with Up  or Down  and then press ENTER  to confirm it. The meaning of the choices is as follows:

Store permanently: The new parameters are stored in the unit internal memory. They will be used immediately and for all the next starts.

Save temporarily: The new parameters are used immediately but are not saved in the unit internal memory. Next starts will use the old parameters.

Discard changes: The new parameters are discarded. There are no effects.



Do not switch off the Base Unit power supply during parameter storing. The whole unit configuration might be corrupted and a new configuration download might be necessary.

10.2.3.

Changing the active parameter set

Most of the protection functions have two different parameter sets to cope with different plant situations. This menu allows seeing and changing the active parameter set.

Changing the active parameter set is possible only with the protection in the set mode.



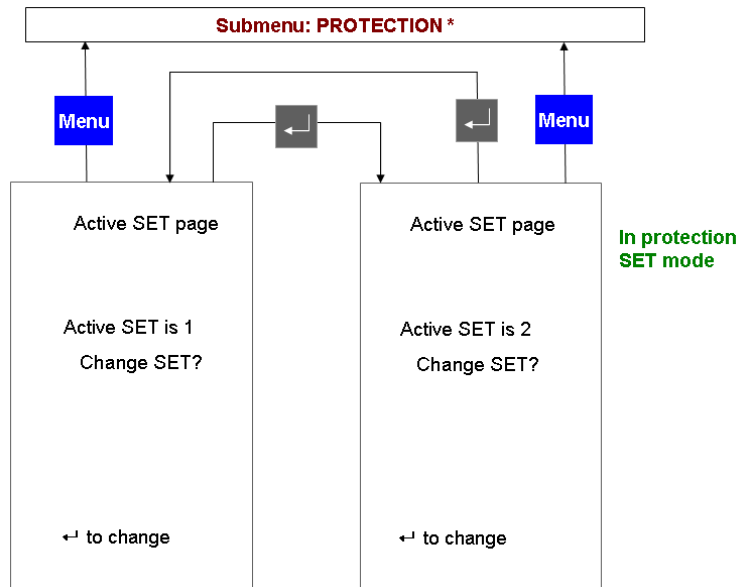



Select the active set page menu and press ENTER  to make the change.



A051349

Fig. 10.2.3.-1 Changing the protection active parameter set

10.2.4. Viewing and changing control parameters

Select the **Control** menu with the navigation push buttons and highlight the desired control function. Press ENTER  to select it. Press again  and the cursor will automatically go to the first control parameter. Use the Up  or Down  button to modify the parameter as wished. After the modification, press  and use Up  Down  to select the next parameter to change.

Repeat the procedure for all the parameters that need to be modified. Then press  to go back to the list of currently installed protection functions. Repeat the procedure for every control function that needs to have the setting modified.

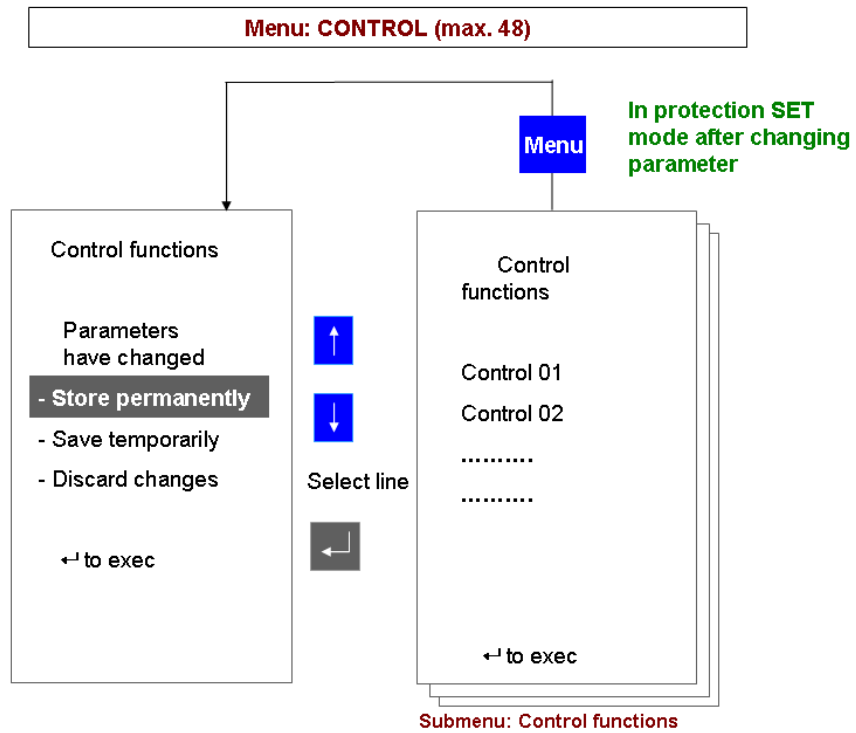

A051350

Fig. 10.2.4.-1 Control parameters page

11. Setting the time and date

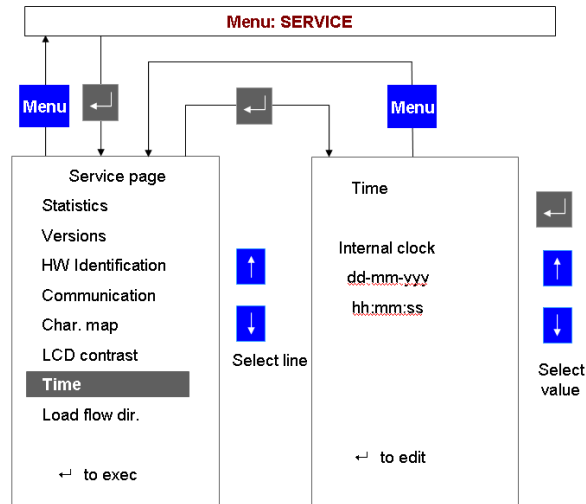

During commissioning, the internal time and date of the unit should be set to the current values. There are a few differences according to the unit configuration.

Standalone unit: The internal time of the unit has to be set to the current value. To do it, select the service menu and then the MC time submenu with the navigation buttons.



A051351

Fig. 11.-1 Setting the time

The time is edited by using UP , DOWN  and then ENTER  to confirm. The complete date and time must be inserted: year, month, day, hour, minutes and seconds.

Unit connected to a master clock: When the unit is connected to a master clock (typically a clock which receives its signal from a GPS), only the year can be set. The remaining part of the date and time is received from the master clock.

Unit connected to a SCADA system: Usually, the SCADA transmits to the unit the date and time according to the used protocol services. There are some differences depending upon the used protocol. IEC 60870-5-103 protocol: The IEC 60870-5-103 module is the time master. Setting the time and date from the HMI is inhibited. LON LAG 1.4 protocol: The LON module is the time master. Setting the time and date from the HMI is inhibited. SPA bus and Modbus protocols: usually, the SCADA sets the date and time, nevertheless setting the time and date from the HMI is allowed.

12. Command page

From this page, it is possible to access the HMI command objects configured in the application software of REF542plus. For more information on these objects, refer to Operating Tool user manual.

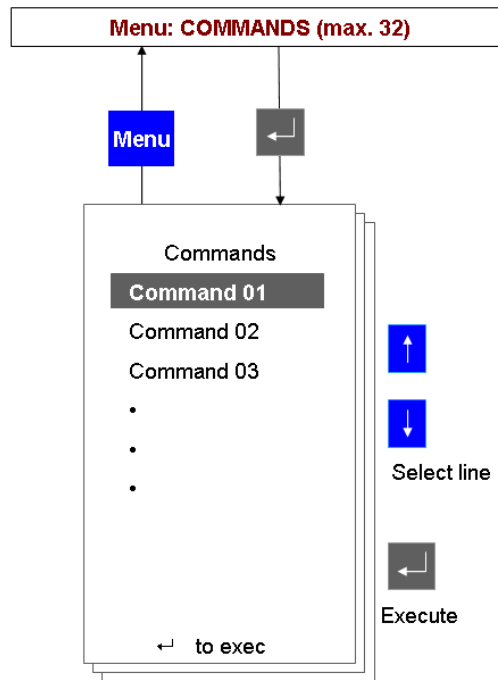

A051352

Fig. 12.-1 Command page

By selecting the desired command and pressing ENTER  the command is executed.

13. REF542plus commissioning mode

The commissioning test mode allows accessing all the digital and analogue inputs and outputs of REF542plus. This mode is independent of the REF542plus application. This working mode has been designed to make easier the wiring verification.

The super user key is required to enter this mode.



Entering this mode STOPS the execution of the protection and control functions. The application software is not running. However, it is not deleted from the permanent memory of the unit. The commissioning test mode should be entered when the switchgear is de-energized and in a safe state.

To switch on this mode the following actions have to be performed in sequence.

- Switch off the REF542plus Base Unit.
- Place the super user key on the e-key sensor and keep it contacted.
- Switch on the Base Unit.

When the Base Unit starts the e-key is detected. The commissioning mode is entered. Verify this reading on the start-up status line “COMMISSIONING MODE”. When this text is visible, the e-key can be unplugged from the e-key sensor.



This mode allows driving directly the binary outputs of the Base Unit. If they are connected to primary objects, operations are thus possible. The interlocking functions are disabled. Before accessing this mode, put the switchgear in safe conditions.

When entering the commissioning mode, the following screen is displayed.

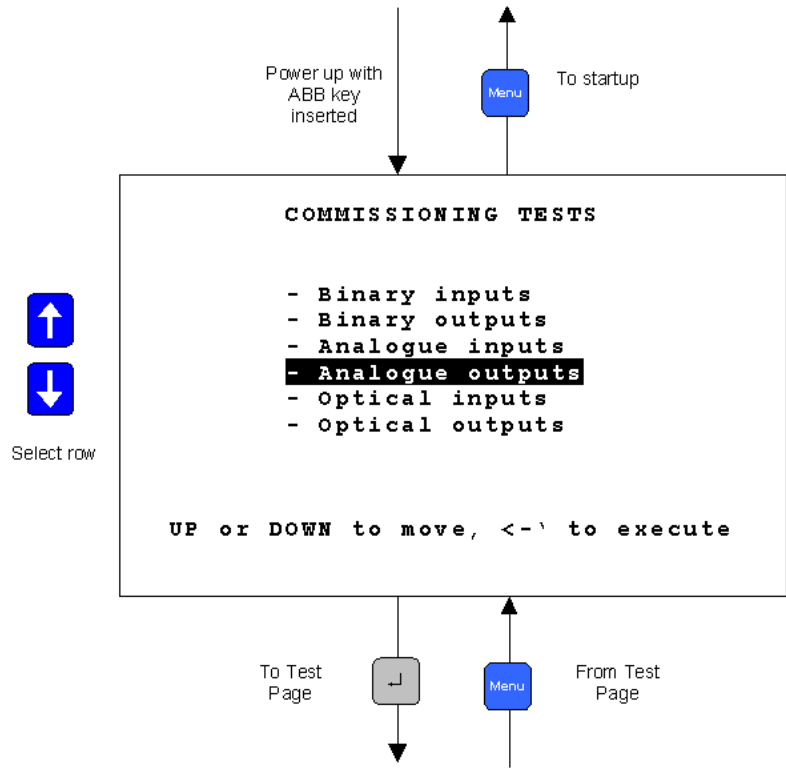

A051353

Fig. 13.-1 Commissioning mode display

13.1.

Binary input commissioning page

This page displays the current status of the binary input channels on the binary IO modules. There are 14 binary inputs per module available. For the binary inputs numbering see Section 18.2. Binary inputs and outputs.

- Line description: "Channel descriptor" "Channel number ": "Values"
- Channel descriptor: Binary input
- Channel number: x-yy. Where x addresses the binary IO slot, yy is the binary input number. 1 means X20 slot and so forth.
- Values: 0 → input is not active. Applied voltage is below the activation threshold.
1 → input is active. Applied voltage is above the activation threshold.

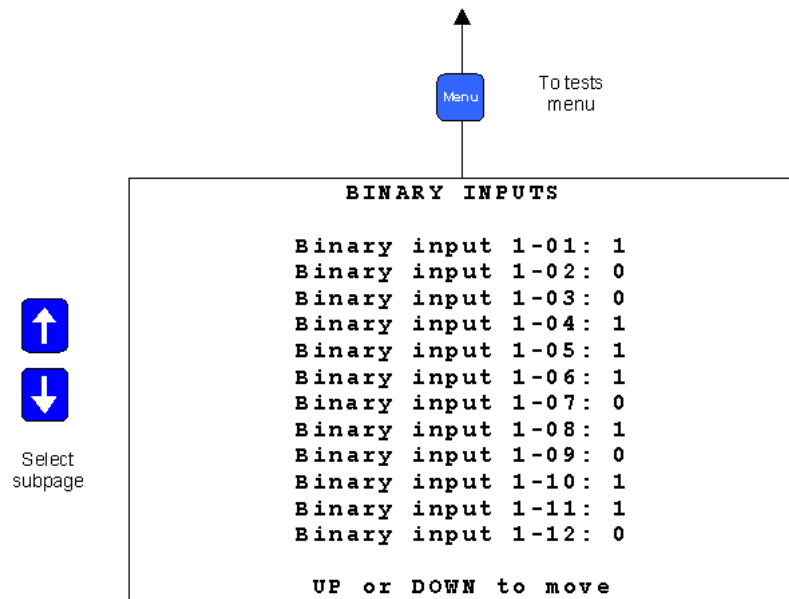

A051354

Fig. 13.1.-1 Binary inputs commissioning page

13.2.

Binary output commissioning page

On this page, it is possible to force the status of the binary outputs. All the outputs can be driven with the exception of the watchdog.

Line description:	"Channel descriptor" "Channel number ": "Values"
Channel descriptor:	Binary output
Channel number:	x-yy. Where x addresses the binary IO slot, yy is the binary output number. 1 identifies the X21 connector and so forth.
Values:	0 → output is opened. The relay is not energized. 1 → output is closed. The relay is energized. Normally opened contacts are closed.

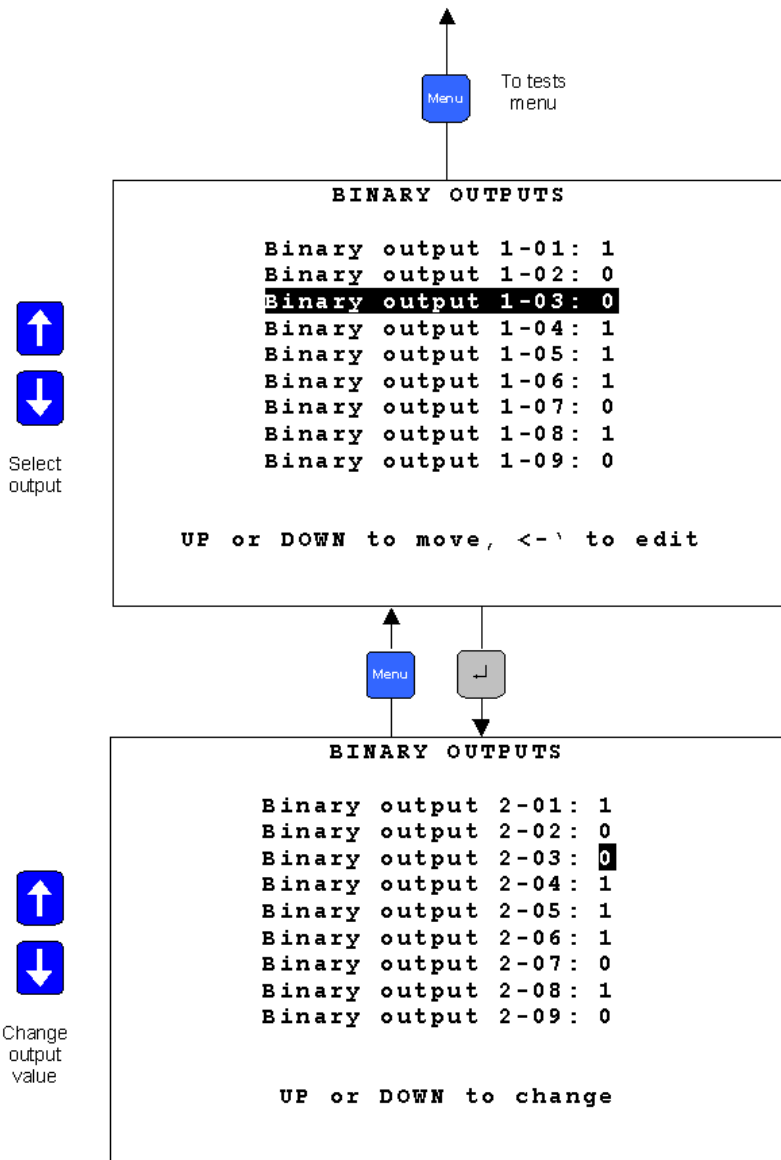

A051355

Fig. 13.2.-1 Binary outputs commissioning page

13.3. Analog input commissioning page

This page shows the analog measurements acquired by the analog input module. The shown values are independent on the rated primary current or voltage of the primary sensors. The measurements are reported in absolute

values taking into consideration as nominal values of the secondary windings 1 Amp and 100 V. If the 5 Amp current inputs are connected applying the nominal rated current, it will be shown 1 A.

Line description: "Channel descriptor" "Channel number ": "Values"
 Channel descriptor: Analog input
 Channel number: x, where x addresses the analog input channel.
 Values:
 CT (1-5 A) → Rated secondary current related to the current input.
 CT (0,2 A) → Rated secondary current.
 VT (100 V) → Rated secondary voltage (Volt).
 Sensor → Voltage output of the sensor (Volt).

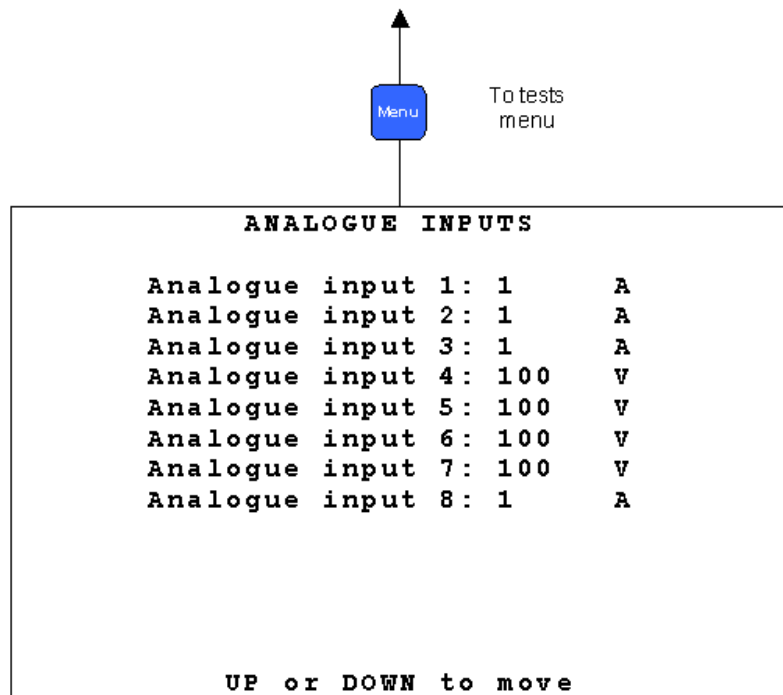

A051356

Fig. 13.3.-1 Analog inputs commissioning page for the 3CT, 3VT, 1VT, 1CT module

With sensor inputs, the displayed values are the voltages read by the analog channels. For example, by using the voltage divider 10.000/1 applying 20 kV on the sensor, the measurement will show 2 Volt. For the current sensor 80 A/ 150 mV, applying 80 Amp on the sensor the measure will be 0.150 Volt.

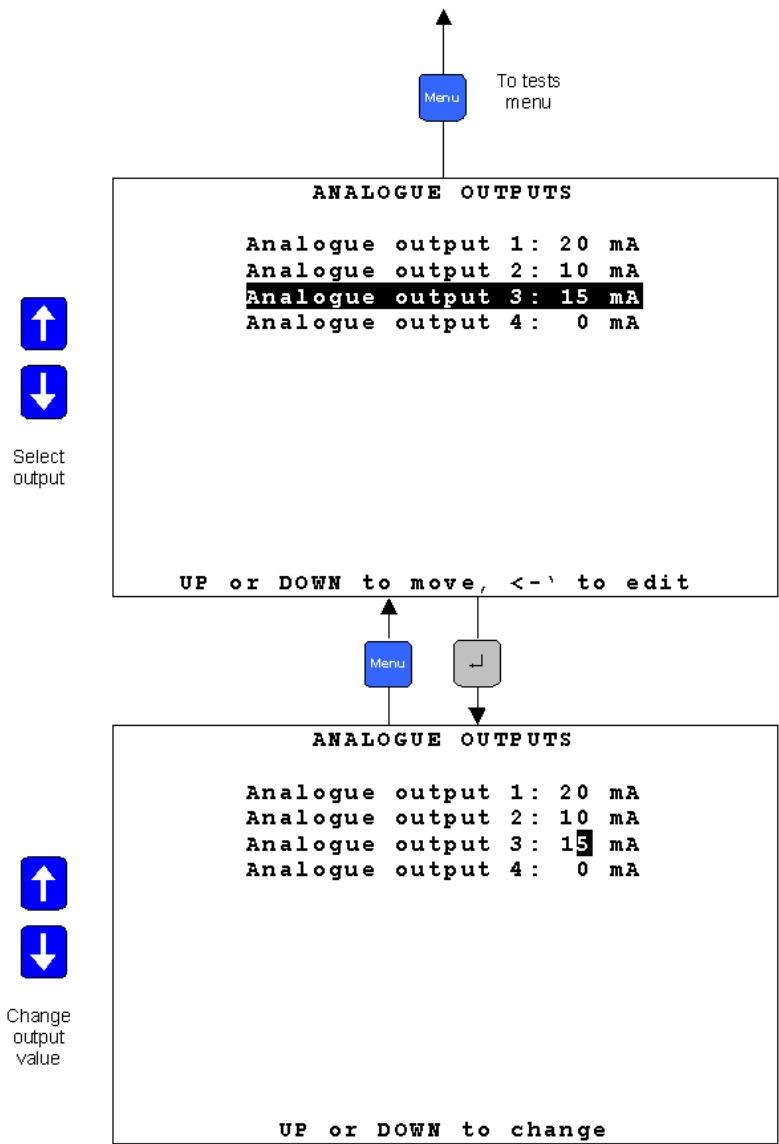

A051358

Fig. 13.4.-1 A 4-20 mA analog outputs commissioning page

13.5. Analog input 4-20 mA commissioning page

From this page, it is possible to read the analog measurements of the Analog Input 4-20 mA module. The shown measurements will be depending on the connected sensor type. In case of a general 4-20 mA sensor, the value of the applied current to the channel is displayed. In case of a SF6 Trafag sensor, the density and the temperature are displayed.

- Line description: "Channel descriptor" "Channel number ": "Values"
- Channel descriptor: General 4-20 mA sensor → General sensor
Trafag → Density, Temperature
- Channel number: x. Where x addresses the analog input channel.
- Values: General Sensor → 4-20 mA, for Trafag the density and the temperature.

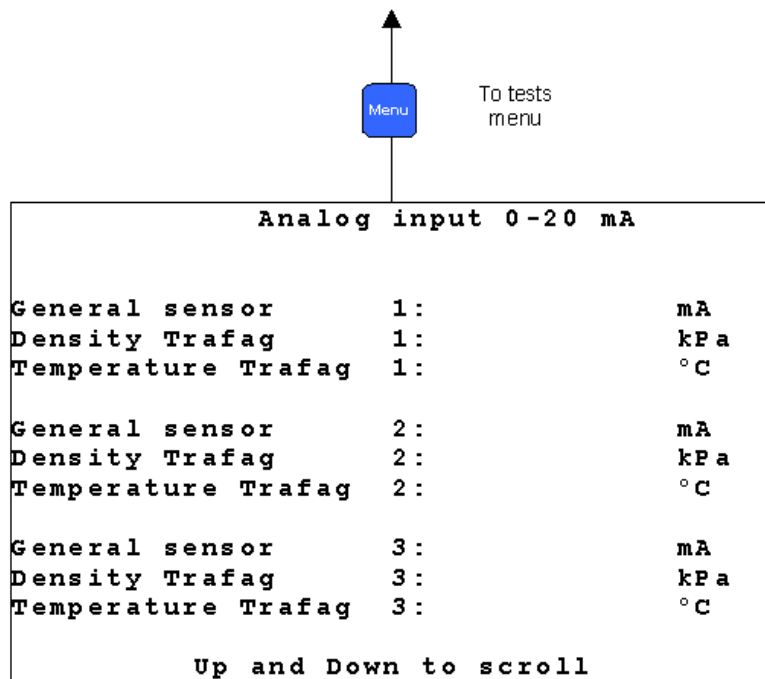

A051359

Fig. 13.5.-1 4-20 mA analog inputs commissioning page

13.6. Optical inputs commissioning page

This page displays the status of the optical inputs on the main module. This mode is available only with main modules equipped with the optical inputs (1VCF751021R0803, X74 only and 1VCF751021R0801 for all).

Line description: "Channel descriptor" "Channel number ": "Values"
 Channel descriptor: Optical Input
 Channel number: x. Where x addresses the optical Input channel.
 1: X74 (time synch input)
 2: X75
 3: X76
 Values: 0: Optical input is off (no light is present).
 1: Optical input is on (light is present).

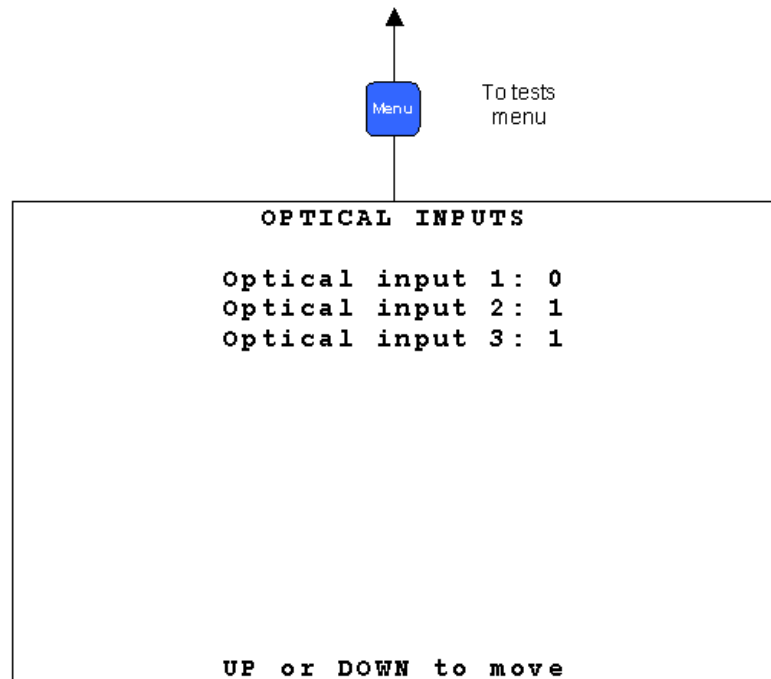



A051360

Fig. 13.6.-1 Optical inputs commissioning page

13.7. Optical output commissioning page

This page allows driving the optical output on the main module (only type 1VCF751021R801).

Line description: "Channel descriptor" "Channel number ": "Values"
 Channel descriptor: Optical output
 Channel number: x. Where x addresses the optical output channel.
 Values: 0: Optical output is off (light not present).
 1: Optical output is on (light present).

The value can be selected with UP , DOWN .

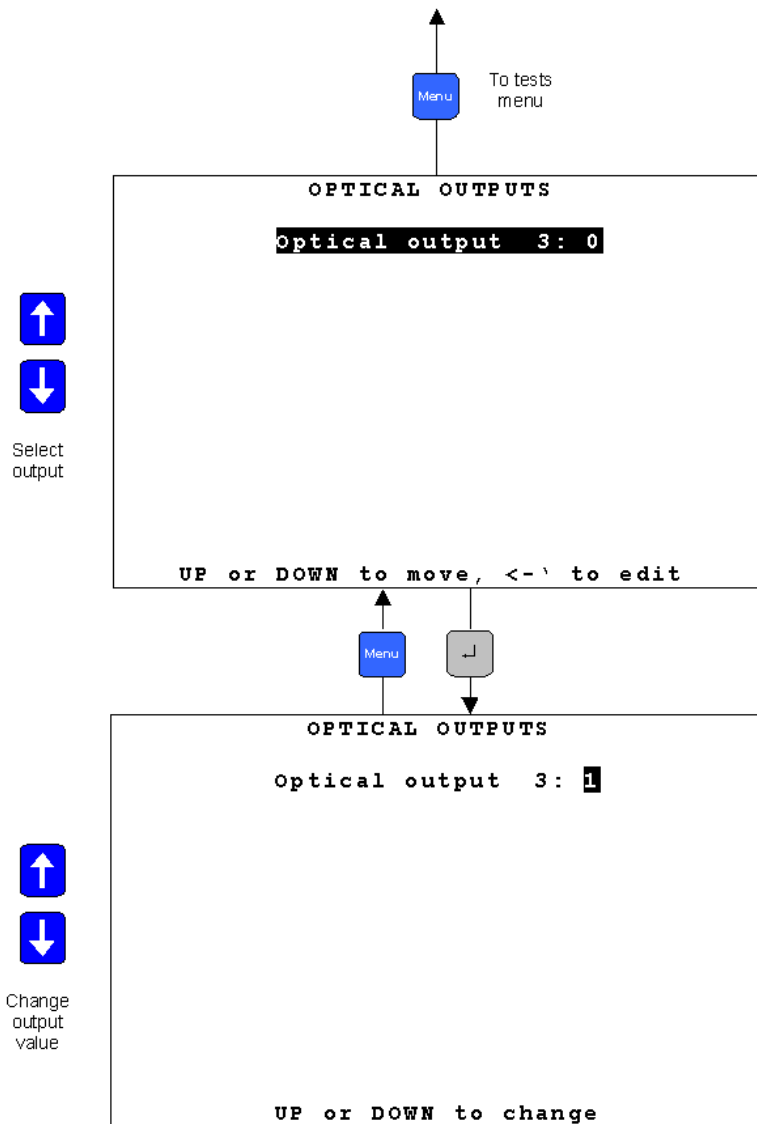

A051361

Fig. 13.7.-1 Optical output commissioning page

14. Connection to PC

14.1. Optical to RS232 converter cable

A special cable with an optical interface is needed to connect REF542plus to a serial port of a PC. This cable is available from ABB.

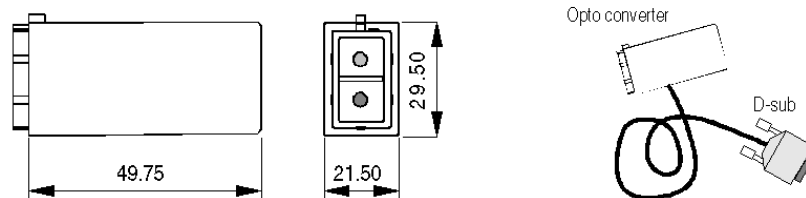
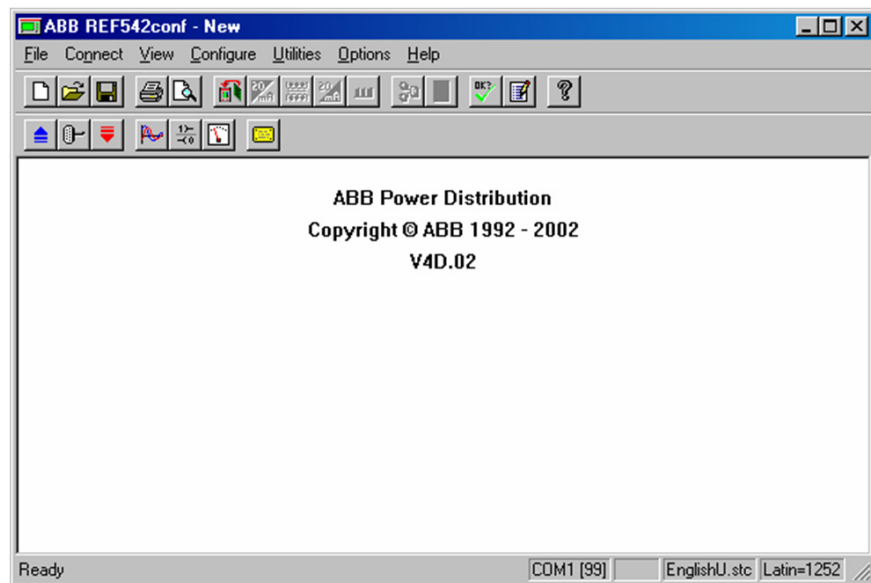

Fig. 14.1.-1 REF542plus serial cable

14.2. Downloading a configuration

When the connection is set up with the appropriate cable, it is possible to download the configuration into REF542plus with the Operating Tool. Connect the optical converter to the optical PC connector on the HMI and the D-sub connector to the PC. Start the Operating Tool on the PC and select the serial port to be used inside the program.



A051363

Fig. 14.2.-1 Operating Tool's transfer menu

14.2.1. Serial port settings

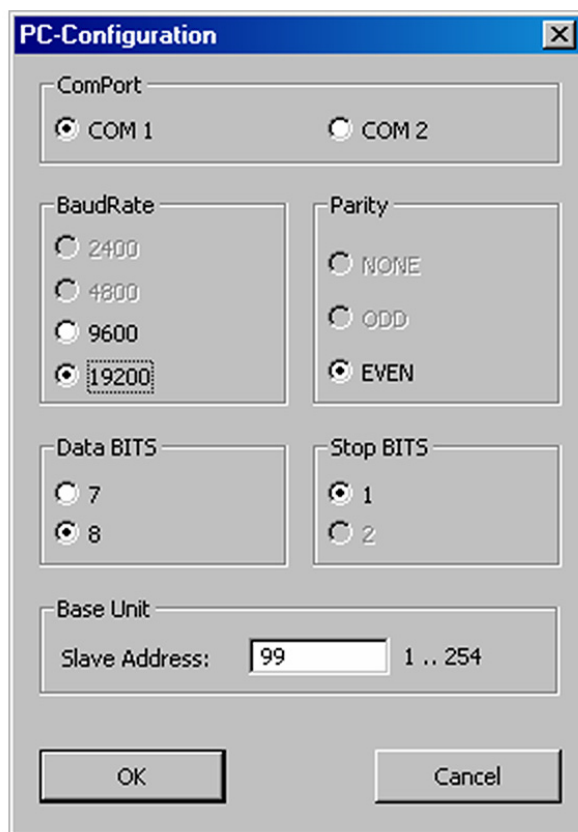

A051364

Fig. 14.2.1.-1 Setting the communication parameter of the serial port

Select the COM port where the RS232/optical cable is plugged in.

Apply the following settings:

Baud rate	19200
Data bits	8
Stop bit	1
Parity	Even

Base Unit slave address: This number can be from 1 to 254. When several Base Units are connected to the same HMI, this number uniquely identifies the Base Unit. The default address is 99. To configure or to change the Base Unit slave address there are two methods:

Multifunction Protection and Switchgear Control Unit

Operator's manual

- Open the application file with the Operating Tool and change it in the hardware settings.

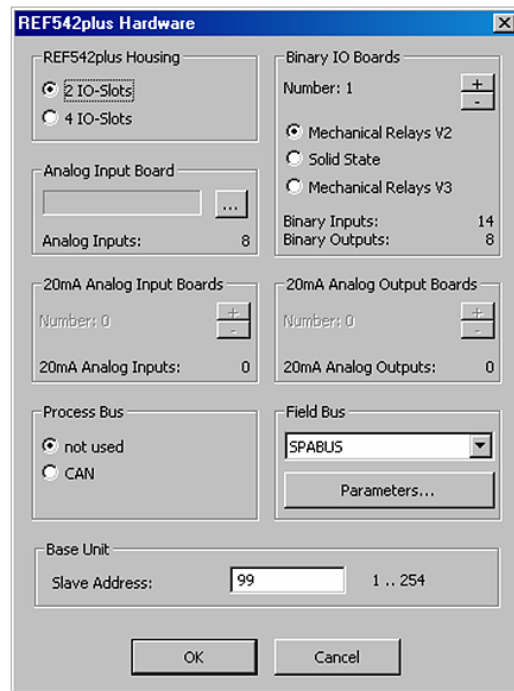

A051365

Fig. 14.2.1.-2 Changing the Base Unit address

- Via the **HMI menu > Service page > Communication > HMI PORT**

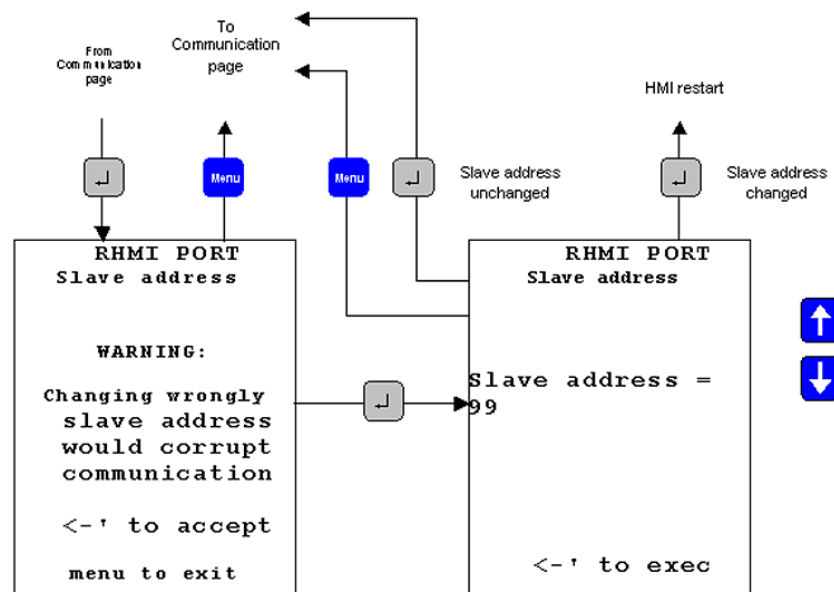

A051366

Fig. 14.2.1.-3 Changing the Base Unit address from the HMI

Please note:

When the ALARM LED is on, the download is inhibited.

The configuration download starts as soon as the relevant push button on the Operating Tool is clicked.

The previous configuration inside REF542plus is destroyed and overwritten by the new one.

REF542plus is fully operational during the download. After the download, REF542plus starts to write the new configuration in the non-volatile with a low priority task in background. This task might take several seconds.



Do not switch off Base Unit power supply during the storing. The whole unit configuration might be corrupted and a new configuration download might be necessary.

The download is possible in all the control modes, but not control.

Communication to the SCADA system is operational during the download.

After the download, REF542plus automatically starts with the new configuration.



When the download is completed, the unit may change the operational status of the output relays due to the new logic configured in the application file. It is strongly recommended to put the switchgear in safe conditions before performing the download.

14.3.

Uploading the configuration

With the Operating Tool, it is possible to upload the current configuration inside REF542plus. Set the Operating Tool and the PC as for the download and click the menu Transfer/load from REF542plus.

Please note:

The uploaded configuration overwrites the current one inside the Operating Tool.

The upload is possible in all control modes and does not affect the functioning of the unit.

14.4. Uploading other information

With the Operating Tool, other information can be uploaded from REF542plus. Different data can be uploaded:

- The fault recorder file
- The binary input status
- The binary output status
- The measurements
- The software version

All this data is accessible with the Operating Tool from the transfer menu. Refer to the Operating Tool manual for more details.

15. Troubleshooting

15.1. Error messages

Base Unit not responding, communication corrupted or wrong slave address

When the HMI is not able to communicate with the Base Unit, the following information appears on the LCD:

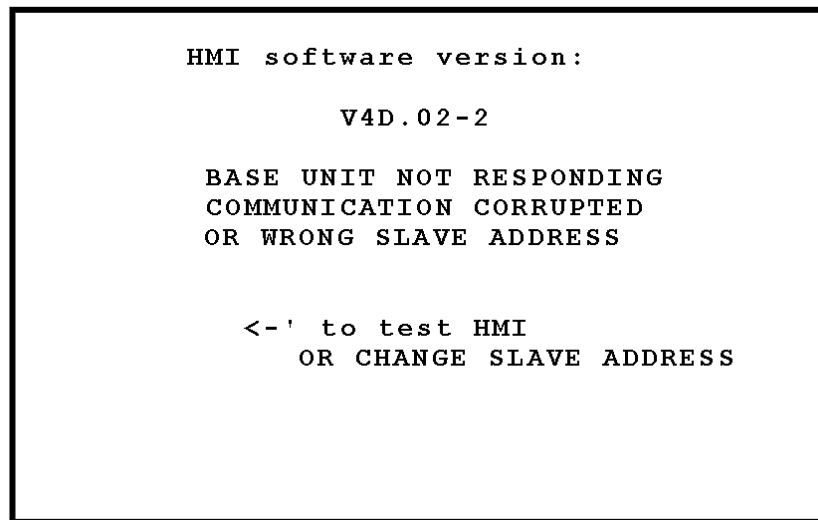

A051367

Fig. 15.1.-1 HMI is not able to communicate with the Base Unit

Solution:

Check that the Base Unit is powered and regularly working. Look at the status LED on the connector panel (Slot X7).

The LED close to the analog inputs is related to the watchdog. When the Base Units is working this LED is on with a weak light.

The other LED is related to the communication with the HMI. When the communication is properly working, this LED is blinking. When the communication is not working, the LED can be either ON or OFF. It depends on when the communication is interrupted.

Check that the connection cable between the HMI and the Base Unit is inserted both in the HMI and in the Base Unit (Base Unit connector X12D) and properly tighten.

Check the slave address of the connected Base Unit to be polled. The address is configured in the application file. If you do not know you can enter the following page by pressing ENTER.

RHMI STAND-ALONE TESTS PAGES

(only if RHMI is not connected to REF542plus or if Slave Address is incorrect)

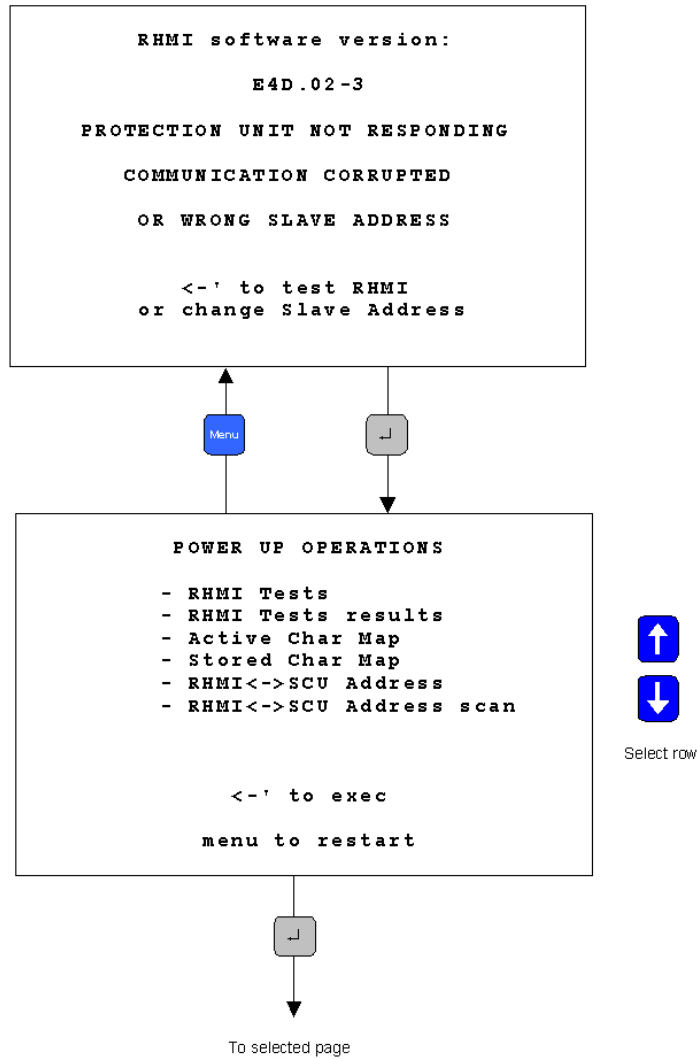

A051437

Fig. 15.1.-2 HMI test page

Select **HMI <-> Base Unit address scanning** menu item and press ENTER.

The HMI will start polling all the addresses to find the connected Base Units. When a unit is found, its address and the feeder name are reported.

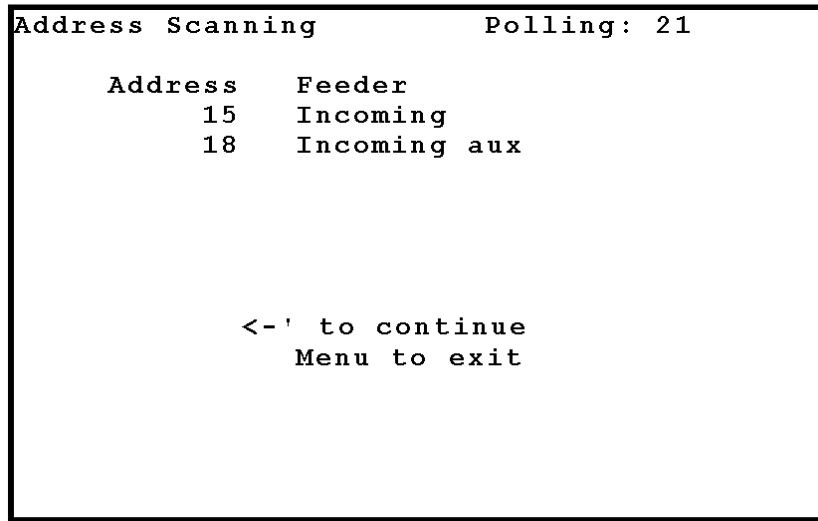

A051438

Fig. 15.1.-3 HMI is polling the Base unit addresses

Select the **HMI <-> Base Unit address** to change the address to be polled.

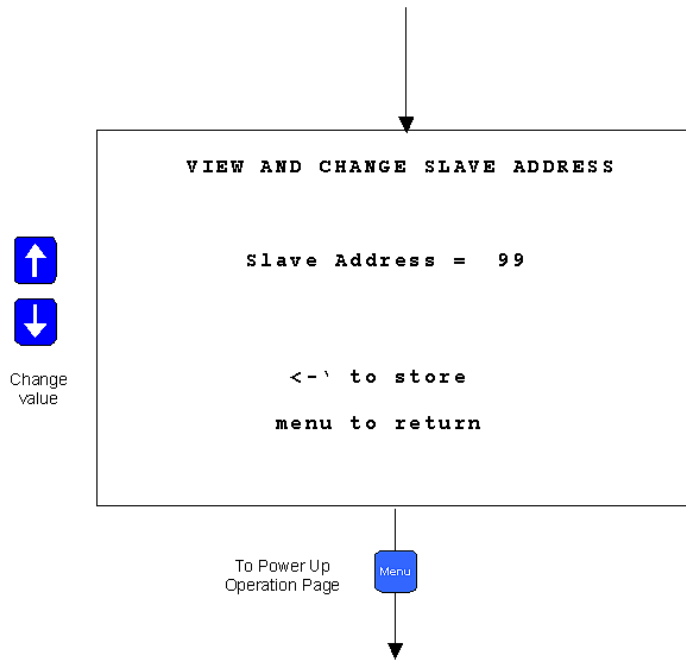

A051439

Fig. 15.1.-4 Changing the Base Unit address to be polled.

HMI Self Test

Press ENTER  to start the test for the HMI.

```
HMI Tests

- Run all tests
- Test LCD      DONE
- Test LEDs
- Test keyboard FAIL
- Test E-key
- Test serial   OK

<- ' to exec
menu to restart
```

Fig. 15.1.-5 HMI test page

REF542plus is without configuration when the following message appears:

```
BASE UNIT NOT CONFIGURED

...Waiting for new configuration...
```

A051441

Fig. 15.1.-6 REF542plus without configuration

Solution:

Download the configuration into the unit by using the serial cable and the Operating Tool.

Configuration not loaded

The following message appears when the downloaded configuration has not been saved inside the unit due to an internal error.

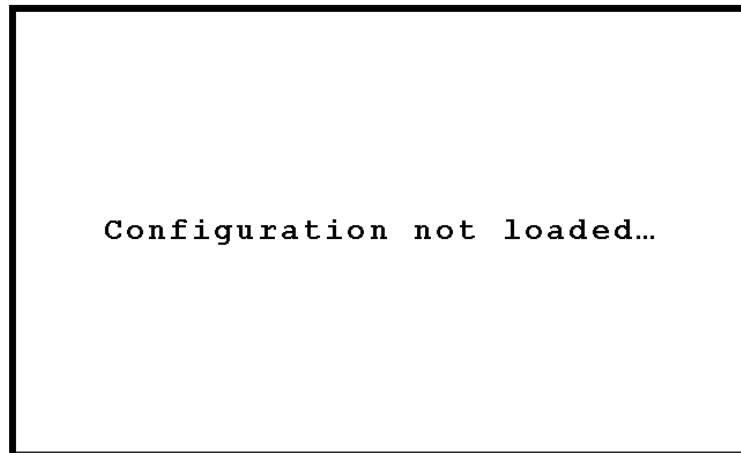

A051442

Fig. 15.1.-7 REF542plus configuration is not stored in the unit internal memory

Solution:

Try to download the configuration again. If after two or three attempts the error remains, contact ABB.

Wrong configuration

The following message appears when a not correct configuration has been downloaded in the Base Unit. This message can also appear when the configuration contains protection functions that exceed the unit functionality level.

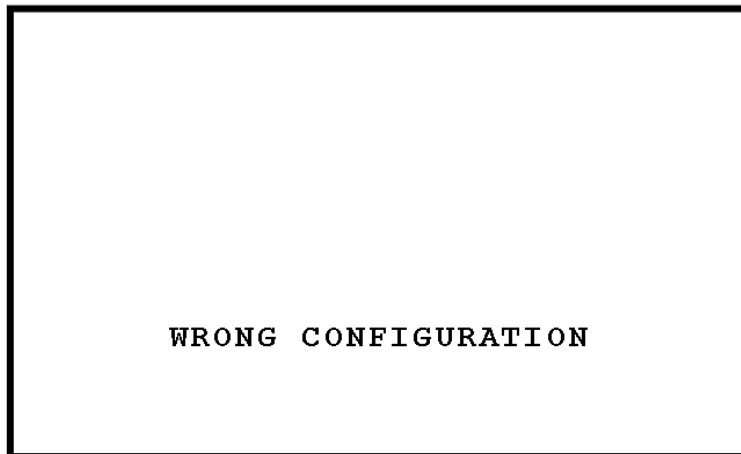

A051443



Fig. 15.1.-8 REF542plus with wrong configuration



For any other error message, contact ABB.

15.2. Clearing the configuration inside the unit

In some cases, there might be the need to delete the configuration stored inside the REF542plus. For example, when the RED alarm is on, it is not possible to download a new configuration inside REF542plus. The following procedure deletes the configuration inside REF542plus:

- Switch off the Base Unit power supply (disconnect the X10 connector from the Base Unit).
- Press simultaneously the UP  and DOWN  buttons on the HMI and keep them pressed.
- Switch on the Base Unit again.

After this procedure, REF542plus is without configuration. Download a new configuration in the unit.



This procedure deletes the configuration stored inside REF542plus. The configuration cannot be recovered. Upload the configuration and save it before deleting it from the unit.

15.3. Primary objects incorrect visualization

The primary object status is usually acquired by REF542plus with 2 distinct contacts, one that is closed when the object is closed and another one that is opened when the object is opened.

The primary object is visualized in open position with a dotted line when both contacts are opened (REF542plus has no voltage at both contact inputs).



A051444

Fig. 15.3.-1 REF542plus has no voltage at both inputs indicating the primary object position

The primary object is visualized both in open and close positions when both contacts are closed (REF542plus has voltage at both its contact inputs).



A051445

Fig. 15.3.-2 REF542plus has voltage at both inputs indicating the primary object position

Solution:

Check the wiring of the primary object. Verify that REF542plus connectors are properly inserted and tightened.

Note: When the primary object is in such an undefined position, issuing an open command will activate the open coil on the circuit breaker. The open operation is never blocked. The close operation with the object in the undefined position is blocked. A close command will be discarded and will turn the interlocking error LED on.

16. Terminology

Term	Description
Ethernet	Physical communication network to transfer Internet data of the REF542plus to the PC and back.
Modbus	By extension, communication board implementing the Modbus protocol for REF542plus.

17. Abbreviations

Abbreviation	Description
BIO	Binary input and output board
CAN	Controller Area Network
CT	Current Transformer
EEPROM	Electrically erasable programmable read-only memory
FUPLA	Function block Programming Language; Function Plan; Function Chart
GPS	Global Positioning System
HMI	Human-Machine Interface
ID	Identification
IEC	International Electrotechnical Commission
IP	Internet Protocol
LAG	Lon Application Guide
LCD	Liquid crystal display
LD	Logical Device
LED	Light-Emitting Diode
LON	Local operating network
MC	Micro controller
SCADA	Supervision, Control and Data Acquisition
SLD	Single-line diagram
SPA	Data communication protocol developed by ABB
VT	Voltage transformer

18. Appendix A: Connection diagrams

The pictures below show the connections plate for REF542plus both in the wide and standard housing versions. The wide housing version can house three binary input and output modules; the communication module, the analog output module or alternatively the analog 4-20 mA input module. The standard housing version can house at most two binary input and output modules and alternatively the communication or the analog output module.

The connectors meaning is explained in the following.



Do not operate a switchgear unless the REF52plus connections are properly done and verified by an expert electrician and tightened.

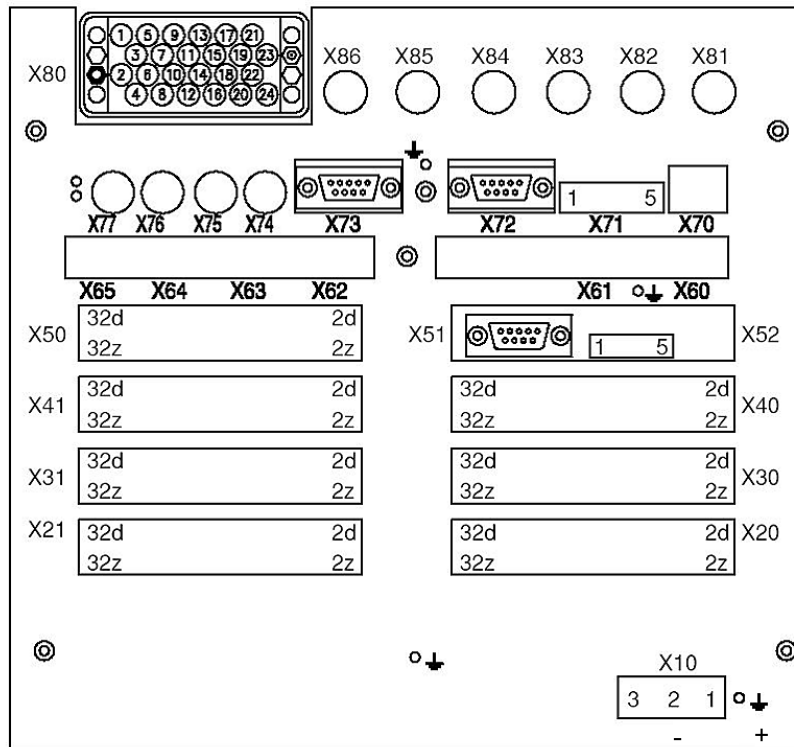

A051446

Fig. 18.-1 REF542plus wide housing connections plate with mixed analog input connector

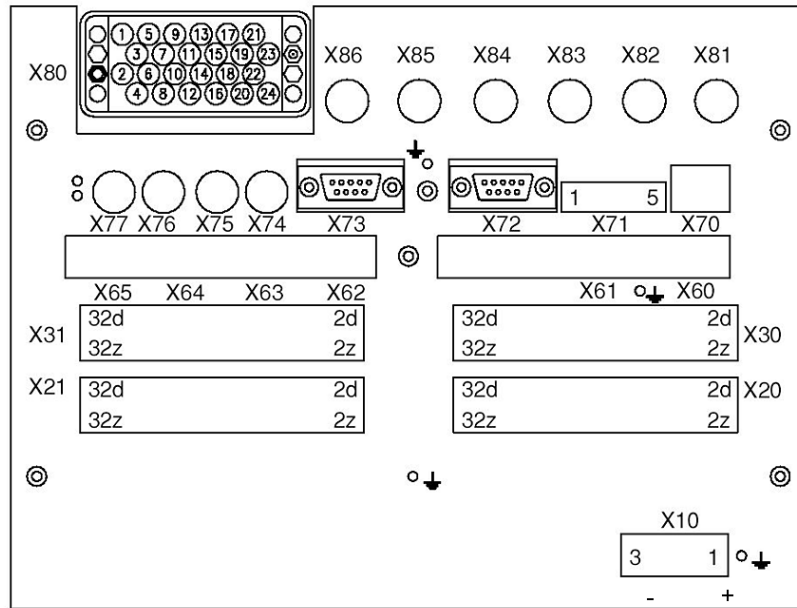

A051447

Fig. 18.-2 REF542plus standard housing connections plate with mixed analog input connector

Table 18.-1 summarizes the connectors.

Table 18.-1 Connectors

Connector	Meaning
X10	Base Unit power supply
X20	First BIO, input
X21	First BIO, output
X30	Second BIO, input
X31	Second BIO, output
X40	Third BIO, input
X41	Third BIO, output
X50	4-20 mA analog outputs, 4-20 mA analog inputs
X51	4-20 mA analog input RS 232 service interface
X52	4-20 mA analog CAN service interface
X60	Modbus RS 485, channel 2; COM L-COM I TX; SPABUS RX
X61	Modbus RS 485, channel 1; COM L-COM I RX; SPABUS TX
X62	Modbus optical, RX channel 1
X63	Modbus optical, TX channel 1
X64	Modbus optical, RX channel 2
X65	Modbus optical, TX channel 2
X70	Ethernet 10 Mb/s Rj45
X71	CAN Open ISO11898 connector
X72	Mainmodule RS 232 service interface
X73	HMI connection

Table 18.-1 Connectors (Continued)

Connector	Meaning
X74	Time synch input
X75	HSTS Input
X76	HSTS Input
X77	HSTS Output
X80	Analog inputs
X81	Sensor 1
X82	Sensor 2
X83	Sensor 3
X84	Sensor 4
X85	Sensor 5
X86	Sensor 6
X87	Sensor 7
X88	Sensor 8

18.1.**Analog Inputs**

REF542plus can have a maximum of 8 analog input channels. These inputs are divided into three measurement groups:

- Measurement Group 1: channel 1, channel 2, channel 3
- Measurement Group 2: channel 4, channel 5, channel 6
- Measurement Group 3: channel 7, channel 8

Group 1 and group 2 have to be homogeneous, which means they can measure 3 currents or 3 voltages. For example, measurements of 1 current and 2 voltages are not allowed.

Group 3 can get any type of signals: 2 currents, 2 voltages, 1 current and 1 voltage and so on. Group 1 and group 2 can be used for homogeneous current or voltage measurements both from instrument transformers and non-conventional sensors. Group 3 can be used in a heterogeneous way.

Channel 7 and 8 in group 3 can be used for earth-fault current with CT type input; residual voltage, or for the synchrocheck function with VT or sensor type input.

The input CT 0.2A is commonly used with a toroidal transformer for sensitive earth-fault current measurement.

Instrument current transformers can have secondary windings ratio /1 A or /5 A. The primary nominal current (for example 400 A) is selected with the Operating Tool. The secondary current (for example /5 A) is automatically selected connecting the right wire to the analog input module.

The Rogowsky coil can be used for current sensing. The correct ratio of the Rogowsky coil is selected with the Operating Tool. The resistive divider can be used for voltage sensing. The ratio is selected with the Operating Tool. The physical input on the unit is the same both for voltage and current sensing, the selection is done via the Operating Tool. Therefore, it is possible for example to use 6 Rogowsky coils, 6 voltage dividers, or 3 Rogowsky coils and 3 voltage dividers.

To detect which analog input module is present inside the unit, look in the identification label stick on the unit itself, or on the HMI service page under the HW identification submenu.

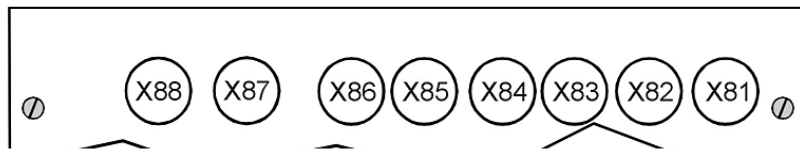

A051450

Fig. 18.1.-1 Connector for sensors analog input module

The analog input for sensor is the same both for voltage and current sensing. To find out whether an input is for current or for voltage, the Operating Tool is needed. X81 corresponds to analog input 1 (sensor 1 in the Operating Tool), X82 to analog input 2 (sensor 2 in the Operating Tool) and so forth.

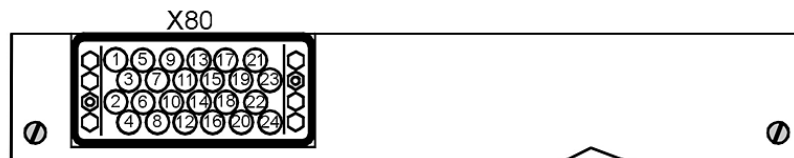

A051451

Fig. 18.1.-2 Connector for conventional instrument transformers

The connector for conventional instrument transformer has twenty-four pins. The following Table 18.1.-1 defines which input is connected to what:

Table 18.1.-1 Connection table for conventional instrument transformers

	VT (100-110/)	CT (1-5A)	CT (0.2A)
1	T5/B	T5/2	
2	T3/B	T3/2	
3	T1/B	T1/2	
4	T8/B	T8/2	T8/A
5	T5/R	T5/1	
6	T3/R	T3/3	
7		T1/3	
8	T8/R	T8/3	T8/B

Table 18.1.-1 Connection table for conventional instrument transformers (Continued)

9		T5/3	
10		T3/1	
11	T1/R	T1/1	
12		T8/1	
13		T4/3	
14	T2/B	T2/2	
15		T6/3	
16	T7/B	T7/2	T7/A
17	T4/B	T4/2	
18		T2/3	
19	T6/B	T6/2	
20	T7/R	T7/3	T7/B
21	T4/R	T4/1	
22	T2/R	T2/1	
23	T6/R	T6/1	
24		T7/1	

B: Black wire for voltage transformer.

R: Red wire for voltage transformer.

1: 1 A input for current transformer.

2: Common input for current transformer.

3: 5 A input for current transformer.

Example:

To determine the pins for the analog input module 1VCF750170R0817: 3CTs, 3VTs, 1CTs; used with transformers with 1 A on the secondary windings.

The following connection must be done:

Analog input 1; the current transformer for phase 1 must be connected on pins 11 and 3 (common).

Analog input 2; the current transformer for phase 2 must be connected on pins 22 and 14 (common).

Analog input 3; the current transformer for phase 3 must be connected on pins 10 and 2 (common).

Analog input 4; the voltage transformer for phase 1 to earth must be connected on pins 21 and 17.

Analog input 5; the voltage transformer for phase 2 to earth must be connected on pins 5 and 1.

Analog input 6; the voltage transformer for phase 3 to earth must be connected on pins 23 and 19.

Analog input 7, for the toroidal transformer for the residual current must be connected on pins 24 and 16 (common).

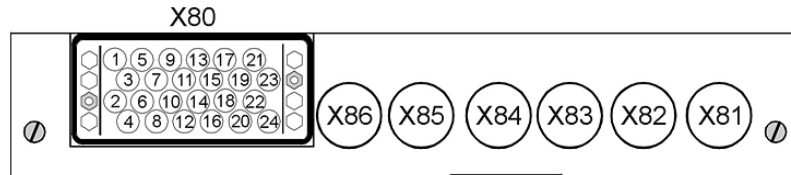

A051453

Fig. 18.1.-3 Connector for mixed analog input module

The picture above shows the connector for the mixed analog input module when both sensors and conventional instrument transformers are used. To find out which connector is used for what, identify the module code from the identification label stick on the unit and see Table 18.1.-1.

18.2. Binary inputs and outputs

Binary input and output modules use the following connectors:

X20 (inputs), X21 (outputs) for the first module.

X30 (inputs), X31 (outputs) for the second module.

X40 (inputs), X41 (outputs) for the third module, available with the wide housing only.

REF542plus can be equipped with two different types of binary inputs and outputs modules: static or with electromechanical relays.

18.2.1. Static

In the static module, digital inputs are implemented with optocouplers and digital outputs are implemented with power transistors. Two different module types are available, with control coil continuity and without.

Each module features: 14 digital inputs, 3 power outputs, 4 normal outputs, 2 signal outputs, 1 watchdog output and optionally 2 coil supervision circuits. For more information, refer to the REF542plus Technical Catalogue.

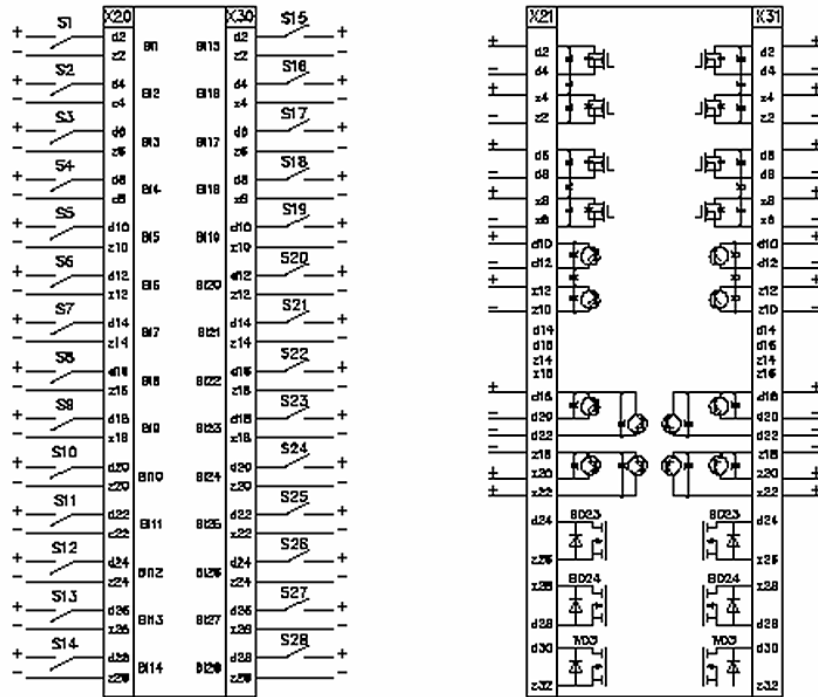

A051454

Fig. 18.2.1.-1 Two static binary inputs and output modules

18.2.2. Electromechanical

In the electromechanical module, digital inputs are implemented with optocouplers and digital outputs are implemented with electromechanical relays.

REF542plus can be equipped with 2 different electromechanical module types, BIO2 and BIO3. The modules are functionally equivalent, with slight variations. These modules are available in different versions. For more information, refer to the REF542plus Technical Catalogue.

18.2.2.1. BIO3

Twelve different types of BIO3 are available depending upon the supply voltage and other features.

Table 18.2.2.1.-1 BIO3 types and codes

BIO3 Code	Description
1VCF750132R0801	Binary I/O3 - 20..90 VDC/14VDC Standard
1VCF750132R0803	Binary I/O3 - 20..90 VDC/14VDC Standard with Static Channel

Table 18.2.2.1.-1 BIO3 types and codes (Continued)

BIO3 Code	Description
1VCF750132R0801	Binary I/O3 - 20..90 VDC/14 VDC Standard with interconnected '1' on inputs
1VCF750132R0803	Binary I/O3 - 20..90 VDC/14 VDC with Static Channel and with interconnected '1' on inputs
1VCF750132R0802	Binary I/O3 - 80..250 VDC/50 VDC Standard
1VCF750132R0804	Binary I/O3 - 80..250 VDC/50 VDC Standard with Static Channel
1VCF750132R0802	Binary I/O3 - 80..250 VDC/50 VDC Standard with interconnected '1' on inputs
1VCF750132R0804	Binary I/O3 - 80..250 VDC/50 VDC Standard with Static Channel and with interconnected '1' on inputs
1VCF750132R0805	Binary I/O3 - 80..250 VDC/72 VDC Standard
1VCF750132R0806	Binary I/O3 - 80..250 VDC/72 VDC Standard with Static Channel
1VCF750132R0807	Binary I/O3 - 80..250 VDC/143 VDC Standard
1VCF750132R0808	Binary I/O3 - 80..250 VDC/143 VDC Standard with Static Channel

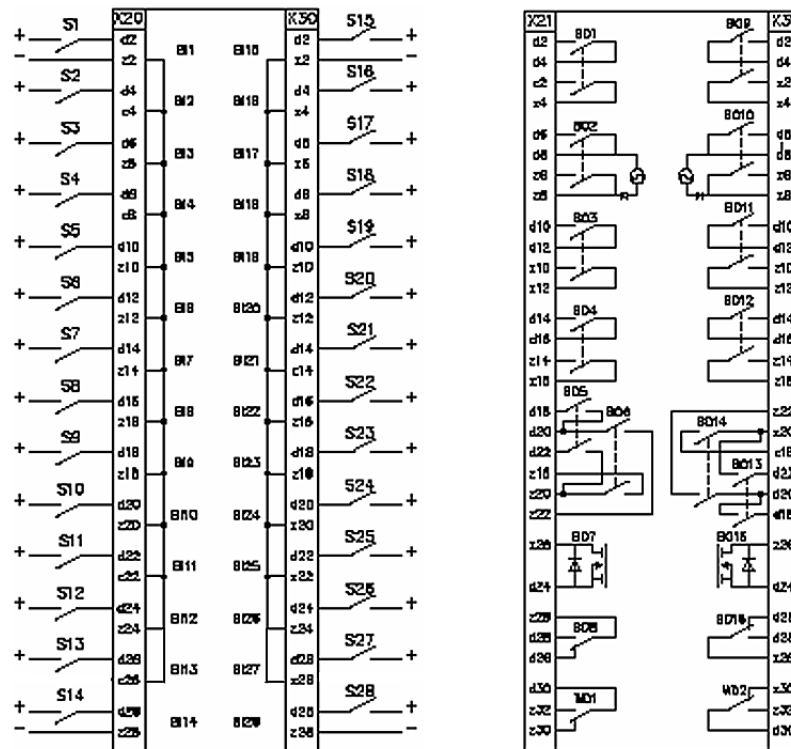

A051455

Fig. 18.2.2.1.-1 2 BIO3 modules with interconnected inputs and the static output

18.3. Other connections

18.3.1. Analog outputs 0/4-20 mA

The 4 analog outputs, when present, are available at connector X50 accordingly to the following ...x-ref...diagram. The not used pins, including the shielding of the cable are connected to ground.

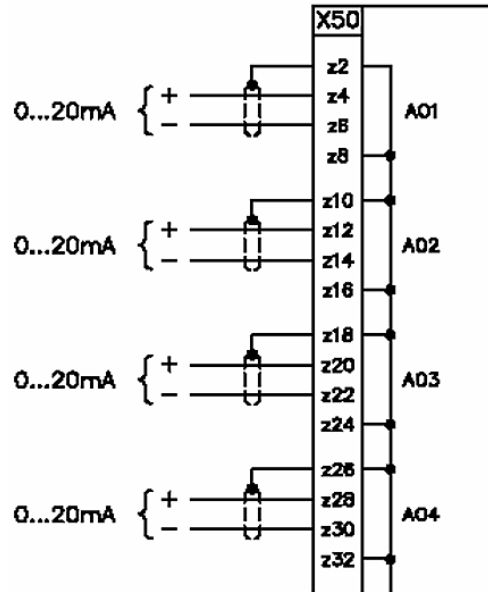

A051457

Fig. 18.3.1.-1 0/4-20 mA analog outputs

18.3.2. Analog inputs 4-20 mA

When present, the 4-20 mA analog input module uses connector X50. Sensor's connections are shown in the picture below...x-ref... X51 and X52 are service interfaces of no use for the user. The output contact BO1 is for the future use.

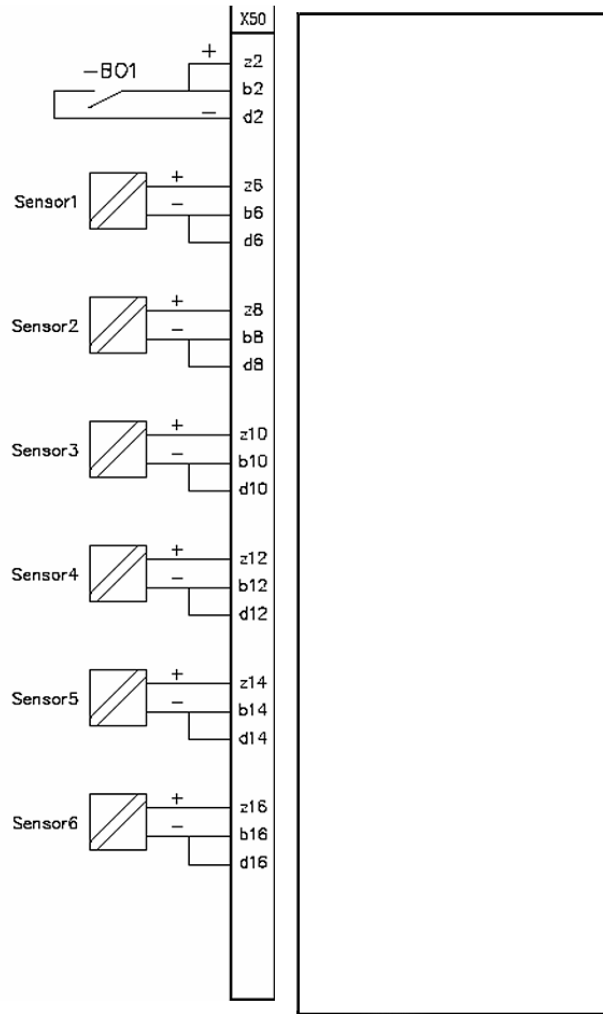

A051458

Fig. 18.3.2.-1 4-20 mA analog inputs



Only passive sensors, for example those that are powered from the loop can be connected to the 4...20 mA analog input module.

18.3.3. Communication module

The communication module uses connectors from X60, X61, X62, X63, X64 and X65 depending on the physical media type (RS 845, glass or plastic fiber).

18.3.4. Power supply

Power supply for the Base Unit is X10.

18.3.5. Time synchronization

The optical input for time synchronization is X74.

18.3.6. HMI

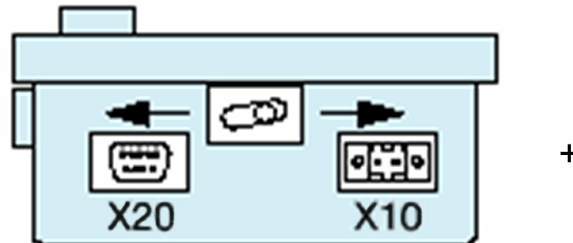

A051459

Fig. 18.3.6.-1 HMI connectors

The HMI power supply is X10 (1 is +, 2 is -), while the serial cable to connect the Base Unit must be connected to X20.



Respect the right polarity on the HMI power supply to avoid damages to the unit.

19. Appendix B: Menu structure

This chapter illustrates the HMI menu structure with the submenus not described in the document.

To access the menu structure, press .

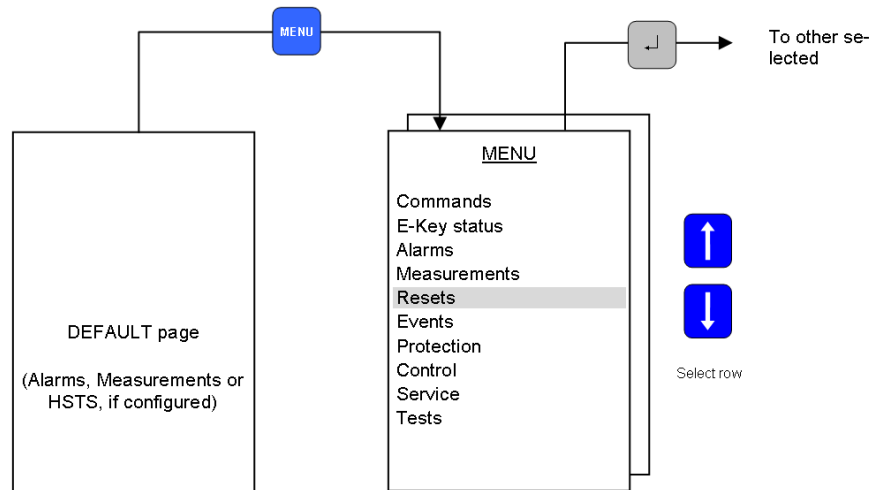

A051460

Fig. 19.-1 REF542plus menu

The accessing in some submenus is restricted to a few operating modes as described in the Table 19.-1 below.

Table 19.-1 Menu access table

Menu / Submenu page	No Control	Local Control	Remote Control	L & R Control	Prot. Set	Prot. Oper.
E-Key status	Yes	Yes	Yes	Yes	Yes	Yes
Measurements	Yes	Yes	Yes	Yes	Yes	Yes
Alarms	Yes	Yes	Yes	Yes	Yes	Yes
Reset page						
- Alarm	-	-	-	-	Yes	Yes
- Max. values	-	-	-	-	No	No
- Energy values	-	-	-	-	No	No
- CB cycles	-	-	-	-	No	No
- Fault recorder	-	-	-	-	Yes	No
- Start/Trip	-	-	-	-	Yes	No
- Counters	-	-	-	-	No	No
Start/Trip page	Yes	Yes	Yes	Yes	Yes	Yes
Active set page						
- View parameter	Yes	Yes	Yes	Yes	Yes	Yes
- Change set	No	No	No	No	Yes	No
Protection functions						

Table 19.-1 Menu access table (Continued)

Menu / Submenu page	No Control	Local Control	Remote Control	L & R Control	Prot. Set	Prot. Oper.
- View Parameter	Yes	Yes	Yes	Yes	Yes	Yes
- Change Parameter	-	-	-	-	Yes	No
Control parameters						
- View parameter	-	-	-	-	Yes	Yes
- Change parameter	-	-	-	-	Yes	No
Service page						
- Statistics	Yes	Yes	Yes	Yes	Yes	Yes
- Versions	Yes	Yes	Yes	Yes	Yes	Yes
- Communication address	Yes	Yes	Yes	Yes	Yes	Yes
- LCD contrast	Yes	Yes	Yes	Yes	Yes	Yes
- MC time	Yes	Yes	Yes	Yes	Yes	Yes
- Load flow direction	Yes	Yes	Yes	Yes	Yes	Yes
- Autoreclosure mode	No	No	No	No	Yes	No
- IEC 60870-5-103 module	Yes	Yes	Yes	Yes	No	No
Test page						
- HMI Control Unit	Yes	Yes	Yes	Yes	Yes	Yes
- Primary	No	Yes	No	No	No	No

19.1.**Reset page**

From this page, it is possible to reset alarms and other quantities. Some reset actions are possible only if REF542plus is in the proper mode. For example, the fault recorder can be reset only in the set protection mode. An attempt to reset it in the operational mode will be denied.

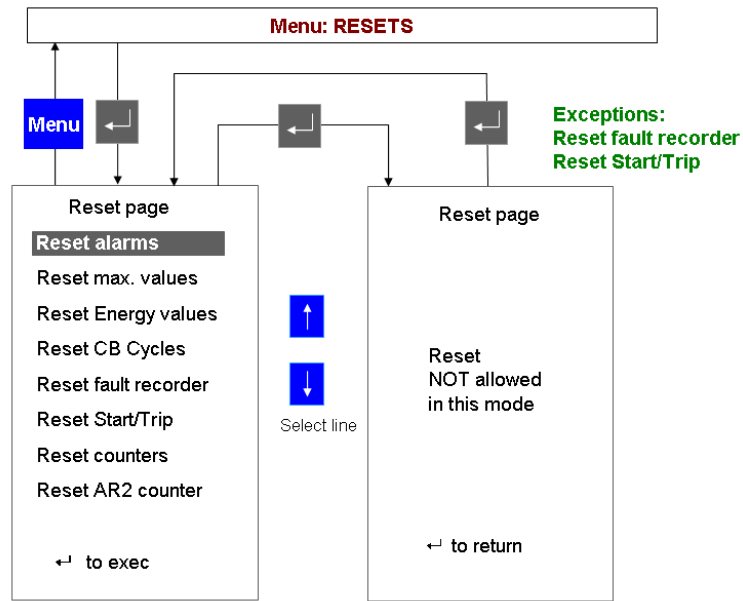

A051461

Fig. 19.1.-1 Attempt to resetting the fault recorder in the wrong mode

Select the quantity to reset with UP and DOWN and press ENTER to execute.

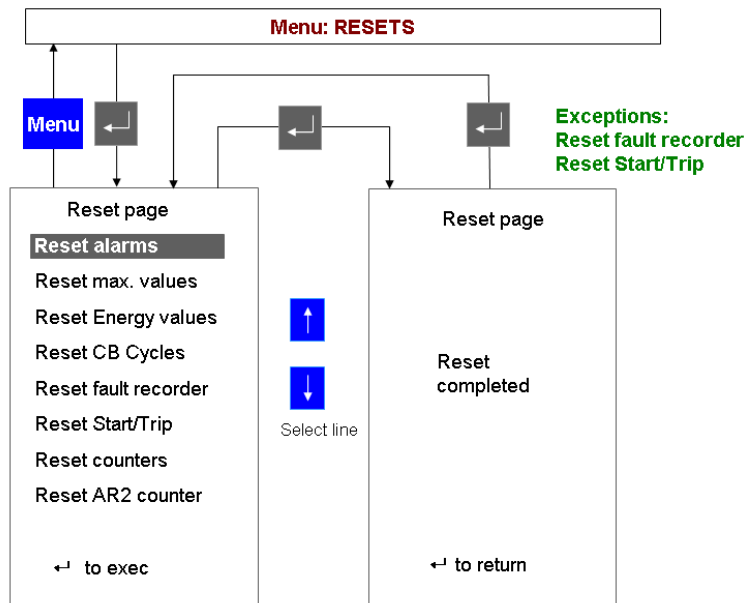

A051462

Fig. 19.1.-2 Resetting a quantity in the proper mode

The quantities that can be reset are:

Reset alarm: can only be reset, if there is no active alarm present anymore. An attempt to reset an alarm caused for example by an interrupted open coil is impossible as long as the coil is not replaced.

Reset max. values: this sub menu resets the maximum and mean current values in the observation period. Also the sum of switched off current is reset from here.

Reset energy values: all the energy values (active, reactive, apparent) are reset from here.

Reset CB cycles: a circuit breaker cycle is a close operation and the subsequent open operation. The unit sums the cycles. This cycle number is reset from here.



Reset fault recorder: the fault recorder data is cleared from here.

Reset Start/Trip: the start and trip protection events are cleared from here.

Reset counters: the unit working hours are reset from here.

19.2.

Service page

The service page menu is composed of several submenus. Browse through the submenus with UP  and DOWN  buttons. Press ENTER  to enter the selected submenu.

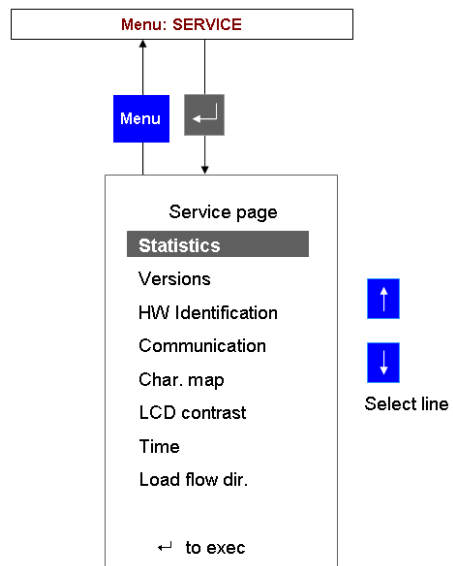

A051463

Fig. 19.2.-1 Service page menu

The service page contains the following submenus.

Statistics

This submenu shows the FUPLA cycle time and other information related to the current configuration in the unit.

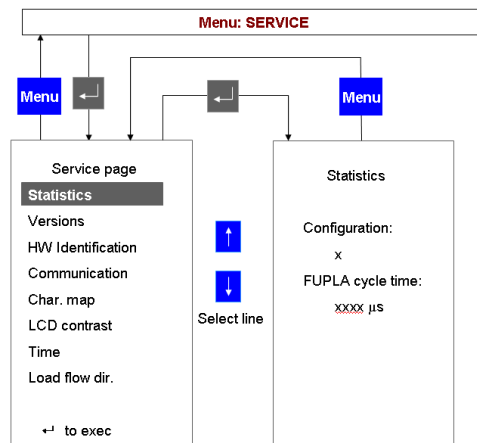

A051464

Fig. 19.2.-2 Statistics submenu

Versions

This submenu displays information on the firmware versions loaded inside the unit.

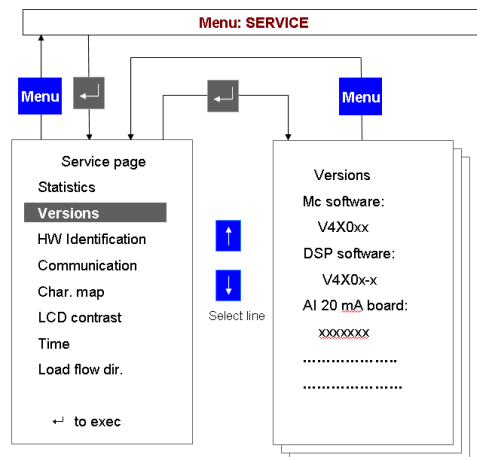

A051465

Fig. 19.2.-3 Versions submenu

Hardware identification

This submenu shows the reference information of the hardware modules installed into REF542plus.

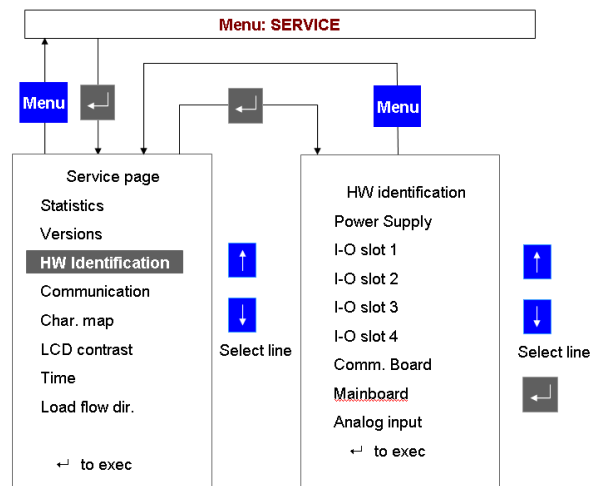

A051466

Fig. 19.2.-4 Hardware identification

Hardware information page

To display the information select the row and press ENTER . When the information is available in the selected module, the following page will be displayed (this information is stored in a dedicated EEPROM on the module itself).

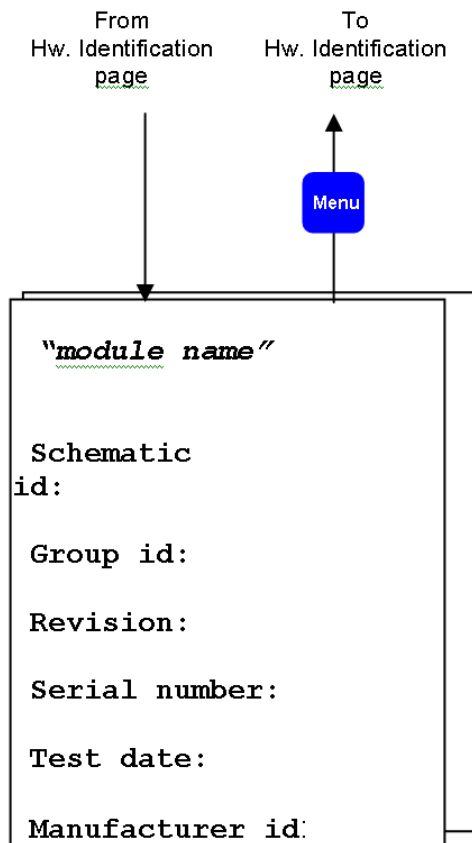

A051467

Fig. 19.2.-5 Hardware information page

When the information from the module is not available the following page is displayed.

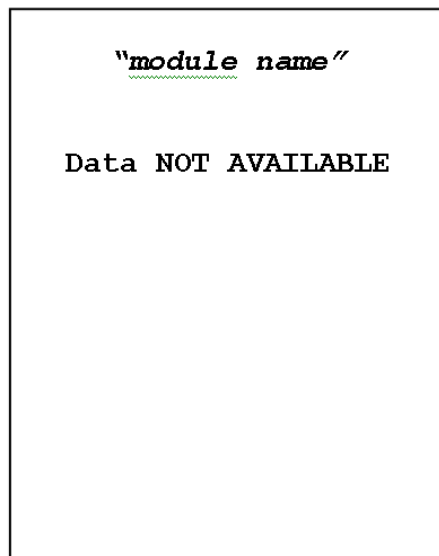

A051468

Fig. 19.2.-6 Hardware information is not available

When the information stored on the module is corrupted, the following page is displayed.

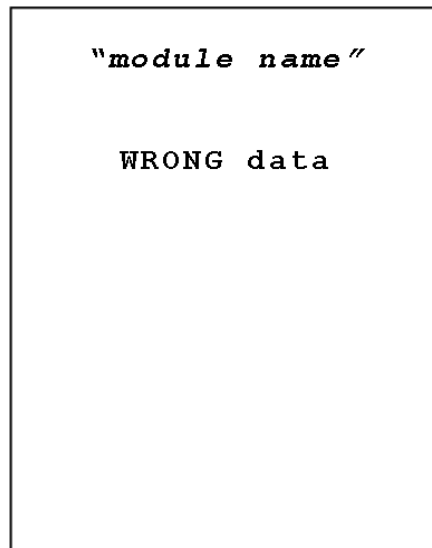

A051469

Fig. 19.2.-7 Hardware information corrupted

When the module is not present or the module is not able to publish the HW identification data, the following page is displayed.

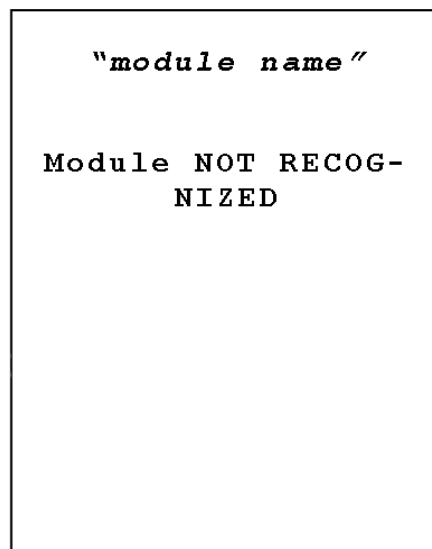

A051470

Fig. 19.2.-8 Hardware information not available

Communication

This subpage displays the information related to the communication ports available and configured in REF542plus.

Multifunction Protection and Switchgear Control Unit

Operator's manual

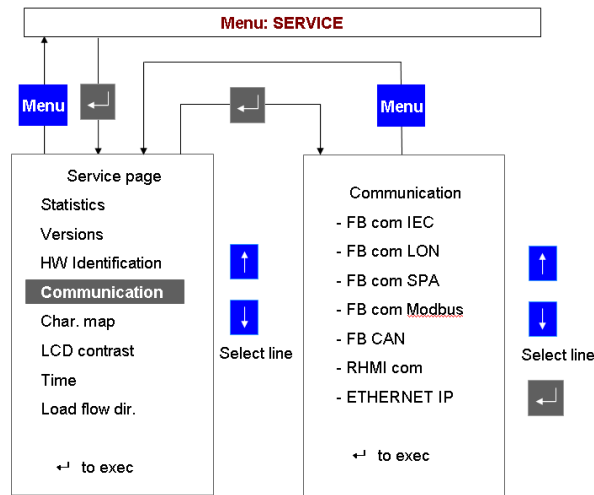

A051641

Fig. 19.2.-9 Communication subpage visualization

When the port is not installed or configured, the following page will be displayed.

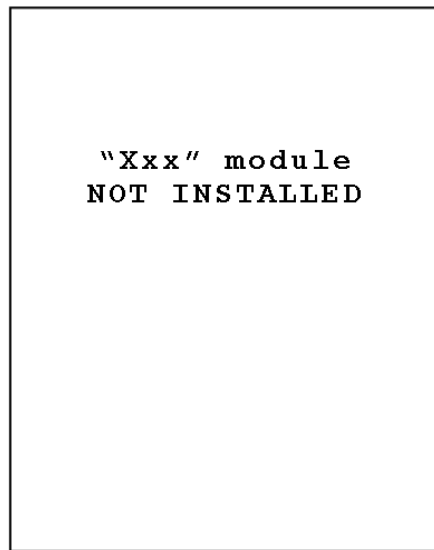

A051642

Fig. 19.2.-10 Communication module is not installed

When the COM-L module for LON communication is installed and active, the following page displays the configured Node ID.

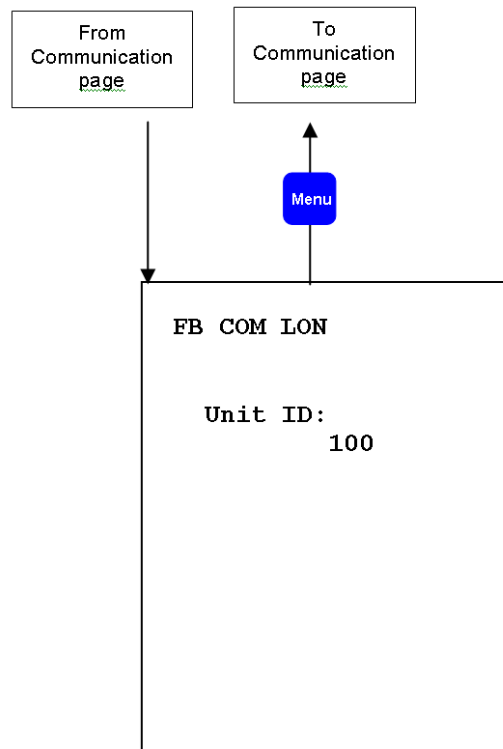

A051643

Fig. 19.2.-11 LON communication module Node Id

When the Modbus module is installed and properly working, the following page is displayed.

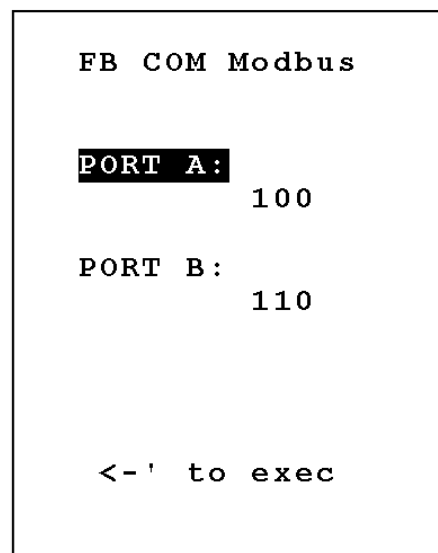

A051644

Fig. 19.2.-12 Modbus communication module page

By selecting the row related to port A or B and pressing , it is possible to change the port communication address.

IEC Communication page

When the IEC 60870-5-103 communication module is installed the following page is displayed.

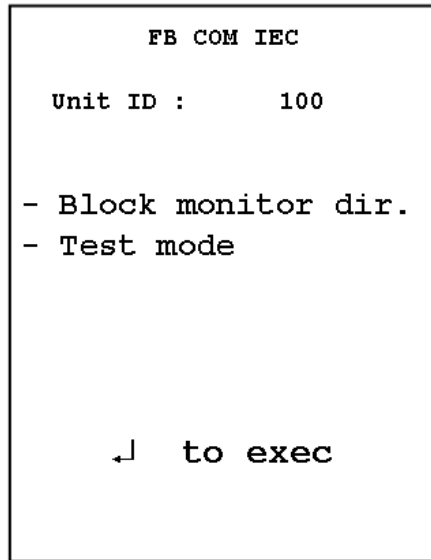

A051645

Fig. 19.2.-13 IEC 103 communication module page

In this subpage, it is possible to block the monitoring direction of the module. For more information, refer to the Communication Module User Manual.

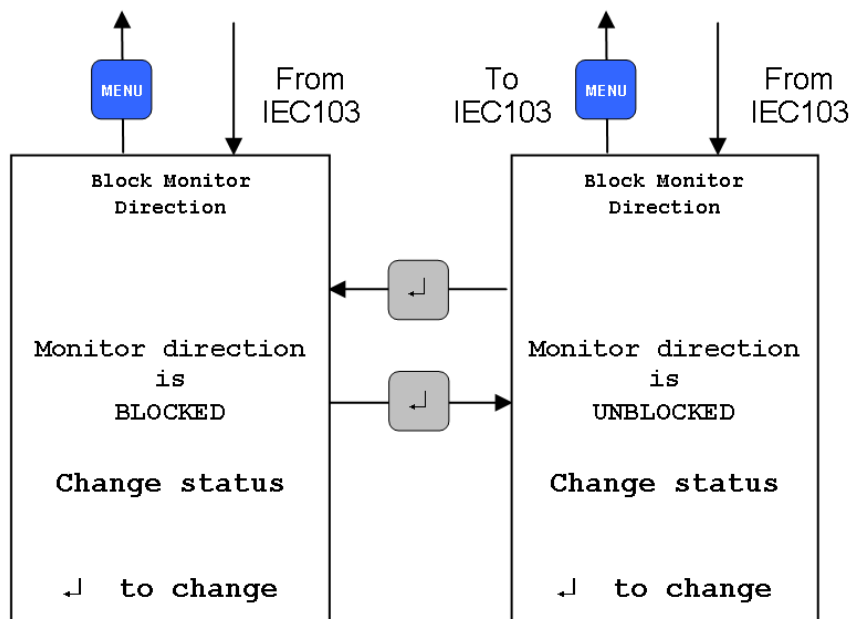

A051646

Fig. 19.2.-14 IEC 103 communication, blocking the monitoring direction

The IEC Test mode menu allows setting and resetting the test mode of the IEC module. For more information, refer to the Communication Module User Manual.

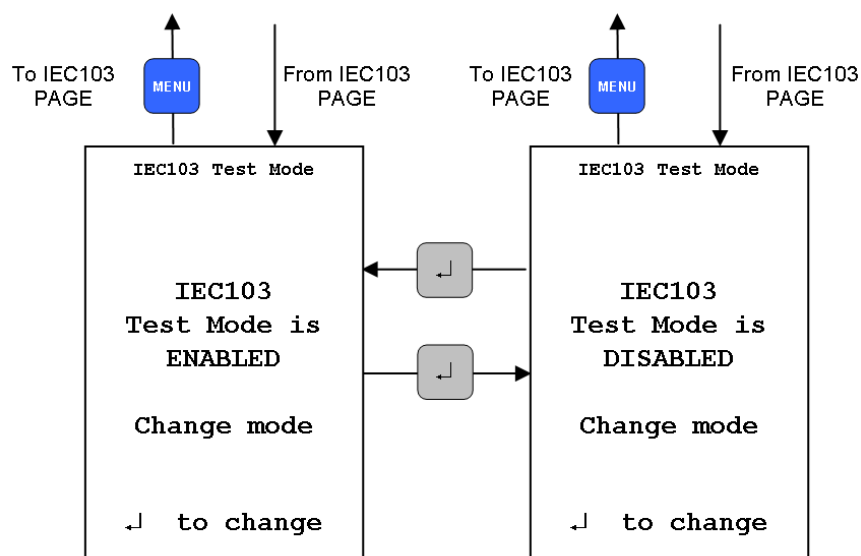

A051647

Fig. 19.2.-15 IEC 103 communication module test mode subpage

SPA bus communication subpage

When the SPA bus communication module is installed, the following page is displayed.

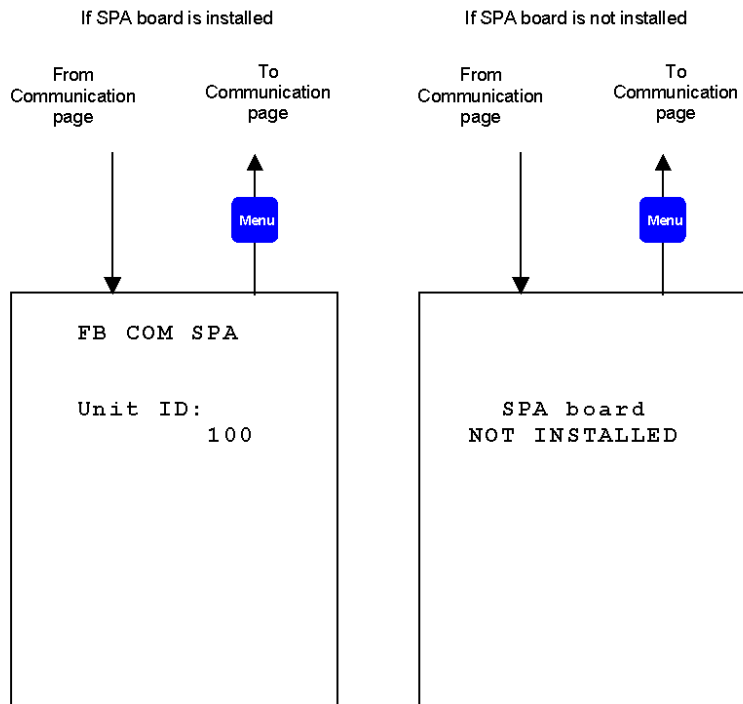

A051648

Fig. 19.2.-16 SPA bus communication module page

It is not possible to modify the SPA bus slave address of the unit on this page.

CAN Communication subpage

When the CAN port has been enabled the following pages display the CAN communication settings.



The CAN communication may only be used by ABB switchgear companies.

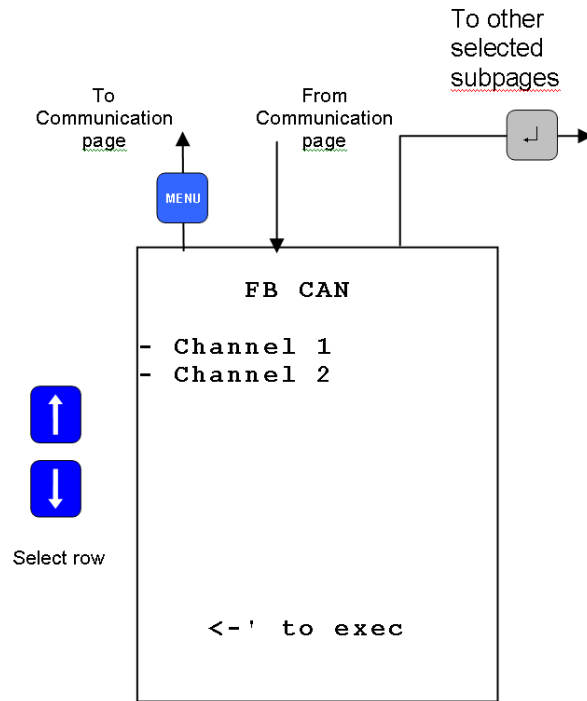

A051649

Fig. 19.2.-17 CAN communication port page

Only channel 1 is currently available. To enter the next subpage, select Channel 1 and press ENTER . The following page is displayed.

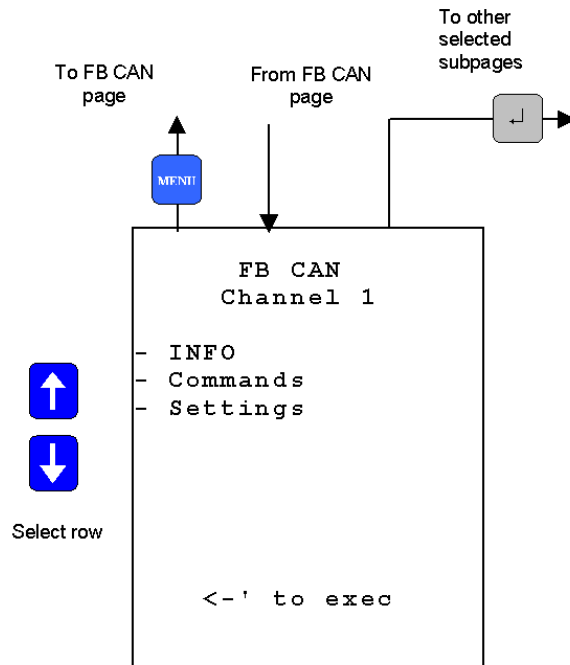

A051650

Fig. 19.2.-18 CAN communication port subpage

CAN INFO subpage

This page displays the CAN status information.

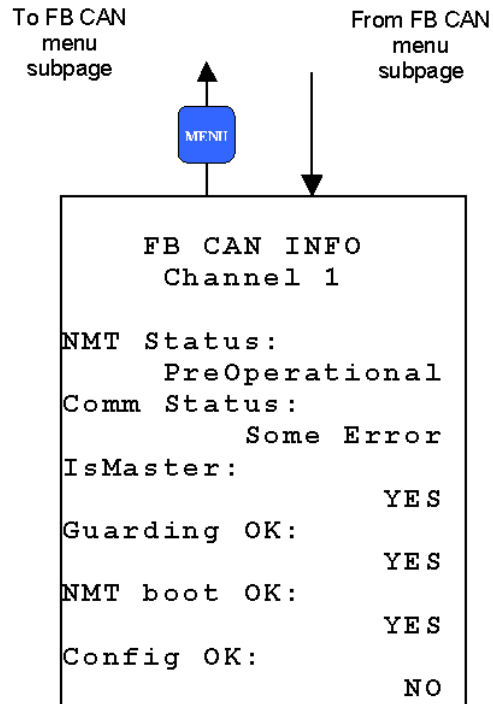

A051651

Fig. 19.2.-19 CAN communication port subpage

CAN Commands subpage

From this page, it is possible to issue direct operation to the CAN communication subsystem. For more information, refer to the CAN Communication User Manual.

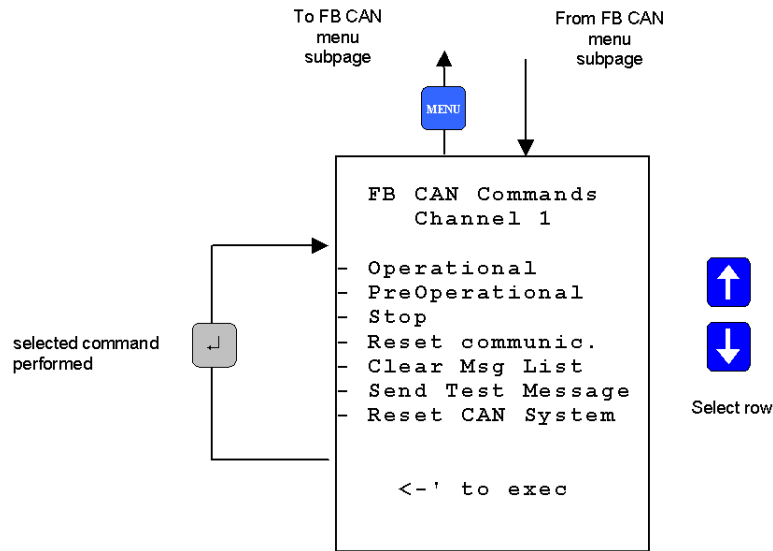

A051652

Fig. 19.2.-20 CAN communication port subpage

CAN setting subpage

In this page, it is possible to change the node address of the CAN communication. This setting is allowed only when the REF542plus node is in the Pre-Operational status.

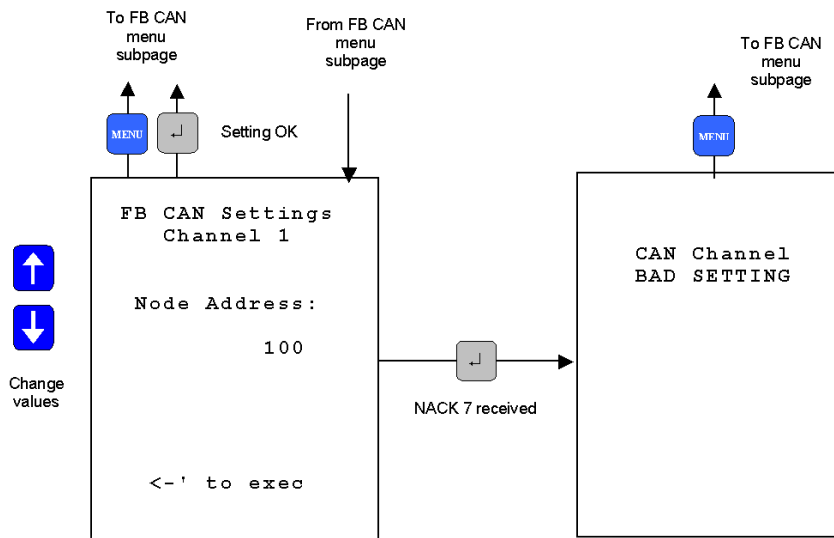

A051653

Fig. 19.2.-21 CAN communication port subpage

HMI Communication subpage

In this page, it is possible to change the Base Unit slave address used to communicate with the HMI.



When the Base Unit address is changed, the communication with the HMI is lost. To restore it, the Base Unit address must be inserted in the HMI as well. Select the menu item Base Unit Slave Address and insert the same address of the Base Unit.

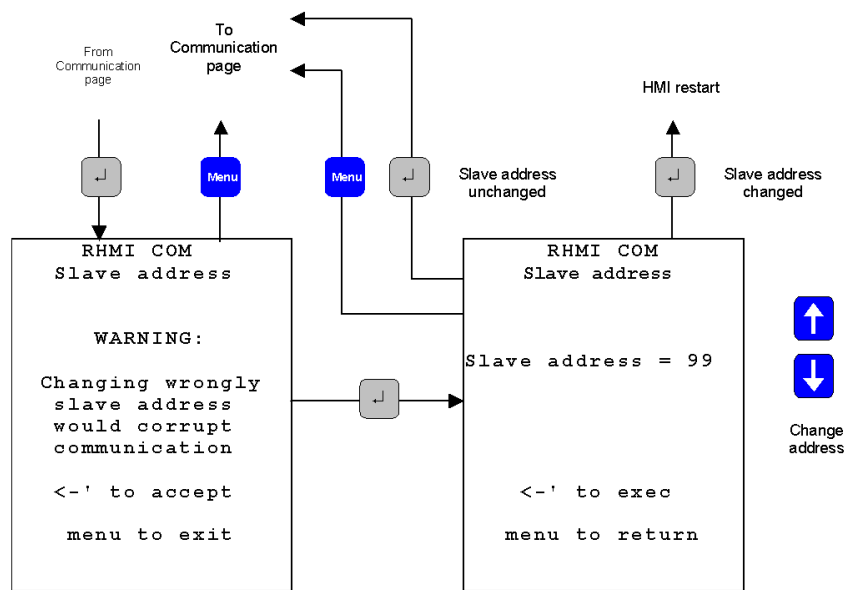

A051654

Fig. 19.2.-22 HMI, changing Base Unit address to be polled

Ethernet communication subpage

This page shows the current settings of the Ethernet communication subsystem. Here, it is possible to visualize the IP and MAC address. The IP and MAC addresses cannot be changed from this page.

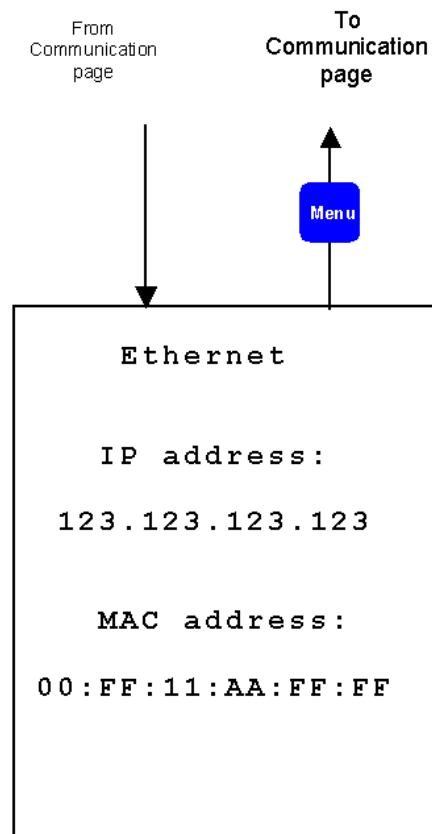

A051655

Fig. 19.2.-23 Ethernet port subpage

Char map

This page shows the active char map used by the HMI. Refer to the Operating Tool User Manual on how to change it.

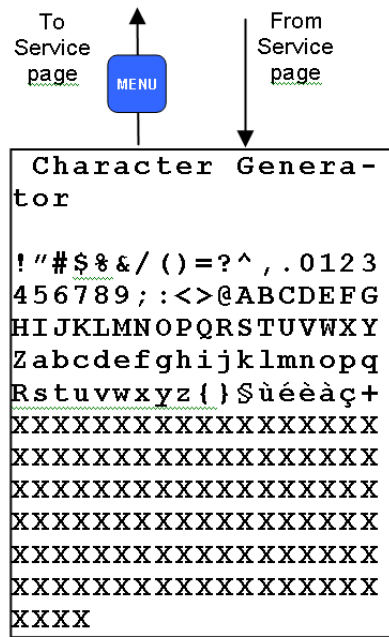

A051656

Fig. 19.2.-24 Char map page

LCD contrast

The LCD screen contrast can be adapted to different light condition from this submenu.

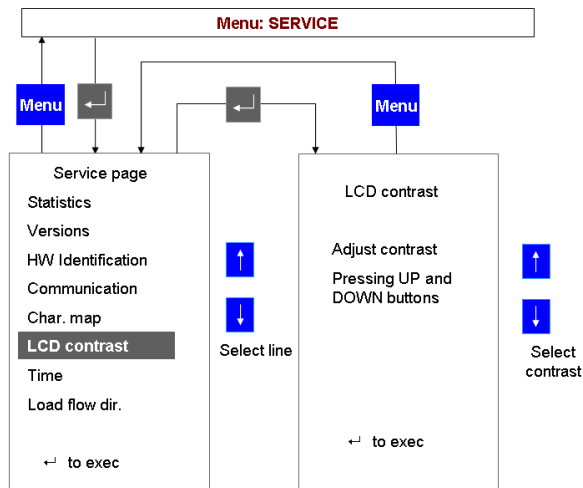

A051657

Fig. 19.2.-25 Adjusting the LCD contrast

Load flow direction

The load flow direction determines how REF542plus computes energy and power. It is set with the Operating Tool and it is also dependent upon the current and voltage transformers (or sensors) connections in the primary parts.

- FORWARD: the power is flowing from the switchgear to the load (outgoing feeder).
- BACKWARD: the power is flowing into the switchgear (incoming feeder).

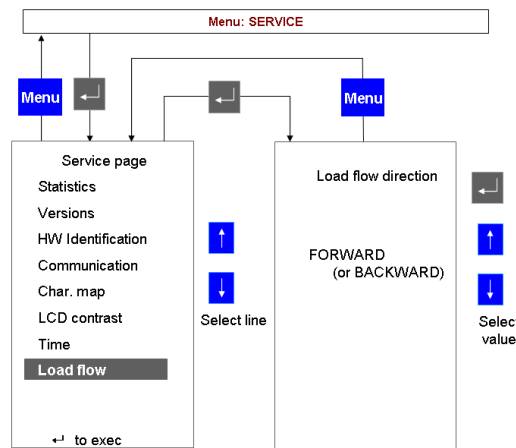

A051658

Fig. 19.2.-26 Load flow direction visualization

19.3. Test page

This submenu allows testing the HMI and the primary part of the switchgear.

19.3.1. Test HMI

When the test HMI is selected, all its features will be tested by switching them on and off.



HMI buttons are not available during the test. The displayed information on the HMI does not reflect the switchgear's actual status. REF542plus is protecting the switchgear during the HMI test. The HMI test takes a few seconds.

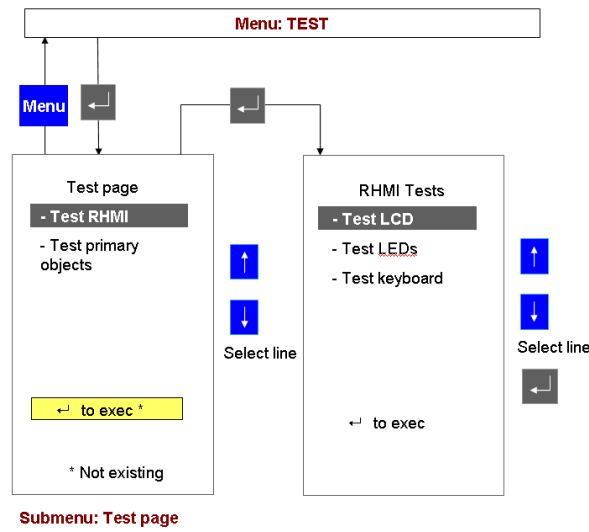

A051659

Fig. 19.3.1.-1 Test page menu

19.3.2. Test primary object

The circuit breaker and other switching devices can be tested from this submenu. The object control buttons are used to perform the desired tests. A warning message is displayed before leaving the test primary object mode.



In test mode, the interlockings are disabled. It is strongly recommended to de-energize the switchgear before activating the test mode.

Verify the primary object's correct position before leaving the test mode and before energizing the switchgear. Make sure all the primary objects are back in the correct positions.

20. Appendix C: Tripping time indication

The example below indicates explain tripping time indication on REF542plus HMI. The example refers to the overcurrent instantaneous protection function.

Setting values in REF542plus are:

Set time = 80 ms

Set threshold = 0,1 In

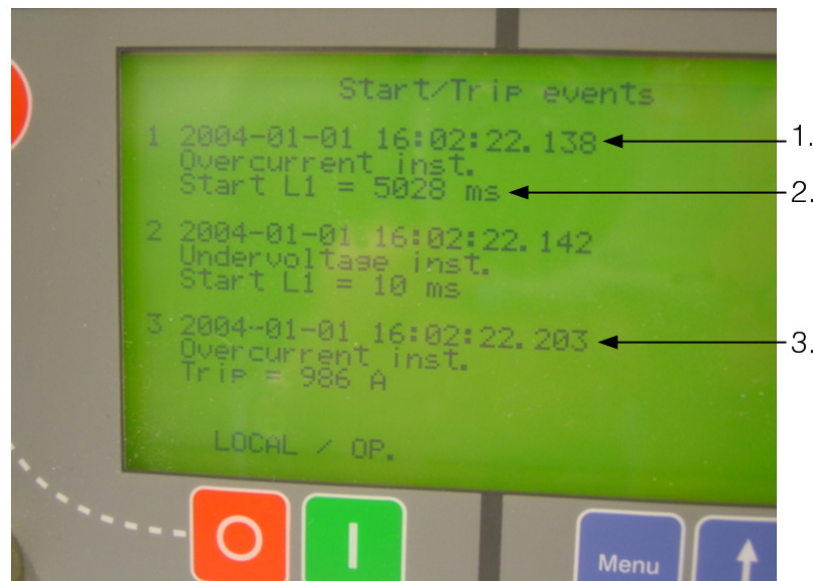

A051660

Fig. 20.-1 Start/Trip events

Event nr.1

The protection function enters the start condition, for example the current is above the set threshold, at 01/01/2004, 16:02:22.138, absolute time. The arrow 1 indicates the time, see Fig. 20.-1.

Event nr. 3

The set time has elapsed with the current above the set threshold. Therefore, the trip signal is generated at 01/01/2004, 16:02:22.203, absolute time. The arrow 3 indicates the time, see Fig. 20.-1.

The set time in REF542plus, 80 ms in this case, must be compared to the time obtained by the following computation:

(Trip signal time: event nr. 3 time)-(start time: event nr.1 time)+compensation time(*)

In this specific case assuming a BIO3 module inside the REF542plus:

203 ms-138 ms+15 ms=80 ms.

The time “Start L1”, 5’028 ms long, indicated by the arrow 2 (see Fig. 20.-1), is the time interval during which the protection remains in the start state (for example active) inside REF542plus.

(*)The compensation time takes into account the signal processing inside the unit and switching time of the contact. The values for the different modules are:

Static IO module 10 ms

BIO3 module 15 ms

BIO2 module 20 ms.



ABB Oy
Distribution Automation
P.O. Box 699
FI-65101 Vaasa
FINLAND
+358 10 22 11
+358 10 22 224 1094
<http://www.abb.com/substationautomation>