



Where Automation Connects.



PLX3x Series Multi-Protocol Gateways

November 8, 2017

USER MANUAL

Your Feedback Please

We always want you to feel that you made the right decision to use our products. If you have suggestions, comments, compliments or complaints about our products, documentation, or support, please write or call us.

How to Contact Us

ProSoft Technology, Inc.
9201 Camino Media, Suite 200
Bakersfield, CA 93311
+1 (661) 716-5100
+1 (661) 716-5101 (Fax)
www.prosoft-technology.com
support@prosoft-technology.com

PLX3x Series User Manual
Rev 1.0.0

November 8, 2017

ProSoft Technology® is a registered copyright of ProSoft Technology, Inc. All other brand or product names are or may be trademarks of, and are used to identify products and services of, their respective owners.

In an effort to conserve paper, ProSoft Technology no longer includes printed manuals with our product shipments. User Manuals, Datasheets, Sample Ladder Files, and Configuration Files are provided at our website:
<http://www.prosoft-technology.com>

Content Disclaimer

This documentation is not intended as a substitute for and is not to be used for determining suitability or reliability of these products for specific user applications. It is the duty of any such user or integrator to perform the appropriate and complete risk analysis, evaluation and testing of the products with respect to the relevant specific application or use thereof. Neither ProSoft Technology nor any of its affiliates or subsidiaries shall be responsible or liable for misuse of the information contained herein. Information in this document including illustrations, specifications and dimensions may contain technical inaccuracies or typographical errors. ProSoft Technology makes no warranty or representation as to its accuracy and assumes no liability for and reserves the right to correct such inaccuracies or errors at any time without notice. If you have any suggestions for improvements or amendments or have found errors in this publication, please notify us.

No part of this document may be reproduced in any form or by any means, electronic or mechanical, including photocopying, without express written permission of ProSoft Technology. All pertinent state, regional, and local safety regulations must be observed when installing and using this product. For reasons of safety and to help ensure compliance with documented system data, only the manufacturer should perform repairs to components. When devices are used for applications with technical safety requirements, the relevant instructions must be followed. Failure to use ProSoft Technology software or approved software with our hardware products may result in injury, harm, or improper operating results. Failure to observe this information can result in injury or equipment damage.

Copyright © 2017 ProSoft Technology, Inc. All Rights Reserved.

Printed documentation is available for purchase. Contact ProSoft Technology for pricing and availability.

North America: +1 (661) 716-5100
Asia Pacific: +603.7724.2080
Europe, Middle East, Africa: +33 (0) 5.3436.87.20
Latin America: +1.281.298.9109

Important Installation Instructions

Power, Input, and Output (I/O) wiring must be in accordance with Class I, Division 2 wiring methods, Article 501-4 (b) of the National Electrical Code, NFPA 70 for installation in the U.S., or as specified in Section 18-1J2 of the Canadian Electrical Code for installations in Canada, and in accordance with the authority having jurisdiction. The following warnings must be heeded:

WARNING - EXPLOSION HAZARD - SUBSTITUTION OF COMPONENTS MAY IMPAIR SUITABILITY FOR CLASS I, DIV. 2;

WARNING - EXPLOSION HAZARD - WHEN IN HAZARDOUS LOCATIONS, TURN OFF POWER BEFORE REPLACING OR WIRING MODULES

WARNING - EXPLOSION HAZARD - DO NOT DISCONNECT EQUIPMENT UNLESS POWER HAS BEEN SWITCHED OFF OR THE AREA IS KNOWN TO BE NON-HAZARDOUS.

THIS DEVICE SHALL BE POWERED BY CLASS 2 OUTPUTS ONLY.

Agency Approvals and Certifications

ATEX Zone 2

CB Safety

CE Mark

RoHS

UL/cUL Class 1 Div 2

Contents

Your Feedback Please.....	2
How to Contact Us	2
Content Disclaimer.....	2
Important Installation Instructions	3
Agency Approvals and Certifications	3
1 Start Here	9
1.1 Overview.....	9
1.2 System Requirements	10
1.3 Package Contents	10
1.4 Mounting the Gateway on a DIN-rail	11
1.5 Jumper Settings	12
1.6 SD Card.....	12
1.7 Connecting Power to the Unit	13
1.8 Installing ProSoft Configuration Builder Software	13
2 Using ProSoft Configuration Builder	15
2.1 Connecting the PC to the Gateway.....	15
2.2 Setting a Temporary IP Address in the Gateway	15
2.3 Setting Up the Project	16
2.4 Disabling Gateway Ports	17
2.5 Configuring Gateway Parameters	20
2.5.1 Renaming PCB Objects	20
2.5.2 Printing a Configuration File	20
2.6 Configuring the Ethernet Port.....	20
2.7 Mapping Data in Module Memory	21
2.7.1 From Address	23
2.7.2 To Address	23
2.7.3 Register Count	23
2.7.4 Swap Code	23
2.7.5 Delay Preset	23
2.8 Downloading the Project to the Gateway	24
2.9 Uploading the Project from the Gateway	25
3 Diagnostics and Troubleshooting	27
3.1 LED Indicators	27
3.1.1 Main Gateway LEDs.....	28
3.1.2 Ethernet Port LEDs	29
3.1.3 Serial Port LEDs (for Gateways with Serial Ports)	29
3.2 Using Diagnostics in ProSoft Configuration Builder	29
3.2.1 Diagnostics Menu.....	32
3.2.2 Capturing a Diagnostic Session to a Log File	33
3.2.3 Using the Data Analyzer (Serial Protocols Only)	34
3.2.4 Warm Boot / Cold Boot.....	36
3.3 Gateway Status Data in Upper Memory.....	36
3.3.1 General Gateway Status Data in Upper Memory.....	37

3.3.2	Protocol-Specific Status Data in Upper Memory	37
4	Hardware Information	39
4.1	Hardware Specifications	39
4.1.1	Serial Port Specifications	40
4.2	Serial Port Cables (for Gateways with Serial Ports)	40
4.2.1	Serial Port Specifications	41
4.2.2	RS-232 - Null Modem (DTE without Hardware Handshaking)	41
4.2.3	RS-232 - DTE to DCE Modem Connection	42
4.2.4	RS-422 Interface Connections.....	42
4.2.5	RS-485 Interface Connection	43
5	EIP Protocol	45
5.1	EIP Functional Overview	45
5.1.1	EtherNet/IP General Specifications	46
5.1.2	EIP Internal Database.....	47
5.2	EIP Configuration.....	49
5.2.1	Configuring EIP Class 3 Server	49
5.2.2	Configuring EIP Class 1 Connection	52
5.2.3	Configuring EIP Class 3 Client[x]/UClient Connection	56
5.3	Network Diagnostics	66
5.3.1	EIP PCB Diagnostics	66
5.3.2	EIP Status Data in Upper Memory.....	67
5.3.3	EIP Error Codes.....	69
5.4	EIP Reference.....	72
5.4.1	SLC and MicroLogix Specifics	72
5.4.2	PLC5 Processor Specifics	76
5.4.3	ControlLogix and CompactLogix Processor Specifics.....	80
5.4.4	EIP Command Entry Form.....	89
6	MBTCP Protocol	91
6.1	MBTCP Functional Overview.....	91
6.1.1	MBTCP General Specifications	92
6.1.2	MBTCP Internal Database.....	93
6.2	MBTCP Configuration	97
6.2.1	Configuring MBTCP Servers	97
6.2.2	Configuring MBTCP Client [x].....	99
6.2.3	Configuring MBTCP Client [x] Commands	101
6.3	Network Diagnostics	104
6.3.1	MBTCP PCB Diagnostics	104
6.3.2	MBTCP Status Data in Upper Memory.....	104
6.3.3	MBTCP Error Codes.....	107
6.4	MBTCP Reference.....	108
6.4.1	About the Modbus Protocol	108
7	MBS Protocol	111
7.1	MBS Functional Overview	111
7.1.1	Modbus Serial Specifications.....	112

7.1.2	Modbus Master/Slave Port Specifications.....	112
7.1.3	MBS Internal Database	113
7.2	MBS Configuration	115
7.2.1	Configuring MBS Port [x].....	115
7.2.2	MBS Port [x] Commands.....	120
7.3	MBS Diagnostics	123
7.3.1	MBS PCB Diagnostics.....	123
7.3.2	MBS Status Data in Upper Memory	123
7.3.3	MBS Error Codes	129
7.4	MBS Reference	130
<hr/>		
8	ASCII Protocol	131
<hr/>		
8.1	ASCII Functional Overview	131
8.1.1	General Specifications	132
8.1.2	ASCII Data Flow.....	132
8.1.3	ASCII Internal Database.....	135
8.1.4	ASCII Modes of Operation	136
8.2	ASCII Configuration.....	138
8.2.1	ASCII Port [x].....	138
8.2.2	Configuring the Port for Receive-Only Mode	141
8.2.3	Configuring a Port for Transmit-Only Mode	141
8.2.4	Configuring a Port for Transmit-Receive Mode.....	141
8.2.5	Termination of Received Data.....	141
8.3	ASCII Diagnostics	143
8.3.1	ASCII PCB Diagnostics.....	143
8.3.2	ASCII Status Data in Upper Memory	144
<hr/>		
9	SIE Protocol	149
<hr/>		
9.1	SIE Functional Overview	149
9.1.1	SIE General Specifications.....	150
9.1.2	SIE Gateway Internal Database.....	150
9.2	SIE Configuration	153
9.2.1	Configuring SIE Client [x] Connection.....	153
9.2.2	Configuring SIE Client x Commands.....	154
9.3	SIE Diagnostics	166
9.3.1	SIE PCB Diagnostics.....	166
9.3.2	SIE Status Data in Upper Memory	167
9.3.3	SIE Error Codes	168
9.4	SIE Reference	170
9.4.1	SIE CPU315-2 DP.....	170
9.4.2	SIE CPU1212C	172
9.4.3	SIE CPU224XP	174
<hr/>		
10	PND Protocol	177
<hr/>		
10.1	PND Functional Overview	177
10.1.1	PND General Specifications.....	177
10.1.2	PND Internal Database	178
10.2	PND Configuration	179
10.2.1	Configuring PIE Connection.....	182
10.2.2	Configuring PND Module Map	183

10.3	Step 7 Configuration	184
10.3.1	Creating a Variable Table to Display Floating Point Input Values.....	186
10.3.2	Creating a Variable Table to Display Floating Point Input Values.....	188
10.3.3	Creating a Variable Table to Display Floating Point Input Values.....	197
10.3.4	Creating a Variable Table to Display Floating Point Input Values.....	199
10.4	PND Diagnostics.....	201
10.4.1	PND PCB Diagnostics	201
10.4.2	PND Status Data in Upper Memory.....	201
10.4.3	Input/Output Error Message Status Codes.....	202
10.4.4	Configuration Error Codes	202
10.5	PND Performance.....	203
11	Support, Service & Warranty	205
11.1	Contacting Technical Support.....	205
11.2	Warranty Information	207
Index		209

1 Start Here

In This Chapter

❖ Overview	9
❖ System Requirements	10
❖ Package Contents - PLX3x	10
❖ Mounting the Gateway on a DIN-rail	11
❖ Jumper Settings	12
❖ SD Card.....	12
❖ Connecting Power to the Unit.....	13
❖ Installing ProSoft Configuration Builder Software	13

To get the most benefit from this User Manual, you should have the following skills:

- **PLC or PAC configuration software:** Launch the program and use it to configure the processor if required
- **Microsoft Windows®:** Install and launch programs, execute menu commands, navigate dialog boxes, and enter data
- **Hardware installation and wiring:** Install the module, and safely connect devices to a power source and to the PLX3x gateway port(s)

1.1 Overview

This document explains the features of the PLX3x gateway. It guides you through configuration, showing how to map data between a device or network, through the gateway, to a PLC or PAC. The ProSoft Configuration Builder software creates files to import into the PLC or PAC programming software, integrating the gateway into your system. You can also map data between areas in the gateway's internal database. This allows you to copy data to different addresses within the gateway database in order to create easier data requests and control.

The PLX3x gateways are stand-alone DIN-rail mounted units that provide one Ethernet port for communications, remote configuration, and diagnostics. Your specific gateway may include additional ports depending on the supported protocols. The module has an SD Card slot (SD card optional) that allows you to store configuration files that you can use for recovery, transferring the configuration to another gateway, or general configuration backup.

1.2 System Requirements

The ProSoft Configuration Builder configuration software for the PLX3x gateway requires the following minimum hardware and software components:

- Pentium® II 450 MHz minimum. Pentium III 733 MHz (or better) recommended
- 128 Mbytes of RAM minimum, 256 Mbytes of RAM recommended
- 100 Mbytes of free hard disk space (or more based on application requirements)
- 256-color VGA graphics adapter, 800 x 600 minimum resolution (True Color 1024 × 768 recommended)

Supported operating systems:

- Microsoft Windows 7 (32 bit) (64bit not tested)
- Microsoft Windows Vista (not tested)
- Microsoft Windows XP Professional with Service Pack 1 or 2
- Microsoft Windows 2000 Professional with Service Pack 1, 2, or 3 (not tested)
- Microsoft Windows Server 2003 (not tested)

1.3 Package Contents

The following components are included with your PLX3x gateway, and are all required for installation and configuration. The quantity of cables provided depends on the specific protocol combination for your gateway.

Important: Before beginning the installation, please verify that all of the following items are present.

Gateway with Ethernet Port

Qty.	Part Name	Part Number	Part Description
1	Mini screwdriver	HRD250	Tool for wiring and securing the power connector
1	Power connector	J180	PLX3x gateway power connector

Gateway with Two Ethernet Ports

Qty.	Part Name	Part Number	Part Description
1	Mini screwdriver	HRD250	Tool for wiring and securing the power connector
1	Power connector	J180	PLX3x gateway power connector

Gateway with Ethernet Port and Single Serial Port

Qty.	Part Name	Part Number	Part Description
1	DB9 to Screw Terminal Adaptor	1454-9F	DB9 to screw terminal adapter
1	RJ45-DB9M Serial Adapter Cable	CABLE14	RJ45 to DB9 male serial adapter cable
1	Power Connector	J180	PLX3x gateway power connector
1	Mini screwdriver	HRD250	Tool for wiring and securing the power connector

Gateway with Ethernet Port and Four Serial Ports

Qty.	Part Name	Part Number	Part Description
4	DB9 to Screw Terminal Adaptor	1454-9F	DB9 to screw terminal adapter
4	RJ45-DB9M Serial Adapter Cable	CABLE14	RJ45 to DB9 male serial adapter cable
1	Power Connector	J180	PLX3x gateway power connector
1	Mini screwdriver	HRD250	Tool for wiring and securing the power connector

1.4 Mounting the Gateway on a DIN-rail

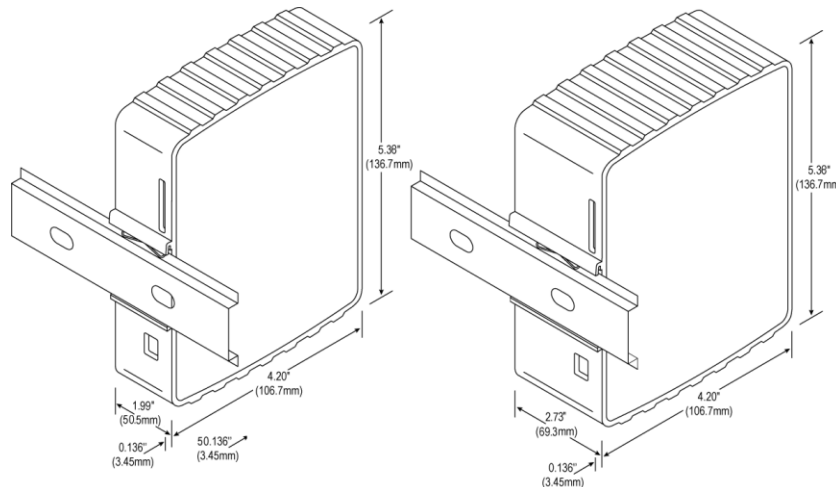

To mount the PLX3x gateway on a DIN-rail, follow these steps.

- 1 Position the gateway on the DIN-rail B at a slight angle.
- 2 Hook the lip on the rear of the adapter onto the top of the DIN-rail, and rotate the adapter onto the rail.
- 3 Press the adapter down onto the DIN-rail until flush. The locking tab snaps into position and lock the module to the DIN-rail.
- 4 If the adapter does not lock in place, use a screwdriver or similar device to move the locking tab down while pressing the adapter flush onto the DIN-rail and release the locking tab to lock the adapter in place. If necessary, push up on the locking tab to lock.

1.5 Jumper Settings

There are three pairs of jumper pins located on the back of the module.

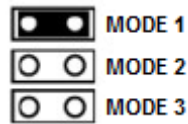

- **MODE 1** - The two pins should be jumpered during normal operation.
- **MODE 2** - Default IP Jumper: This is the middle jumper. The default IP address of the gateway is 192.168.0.250. Set this jumper to put the gateway's IP address back to the default.
- **MODE 3** - Reserved: This is the bottom jumper, reserved for internal ProSoft Technology use only. The firmware will not run when these pins are shorted.

1.6 SD Card

You can order a PLX3x gateway with an optional SD card (Part Number SDI-1G). In the event of a module failure, you can move the SD card from one module to the next and resume operation.

In general, if the SD card is present when you power up or reboot the module, the module uses the configuration on the SC card.

With an SD Card

- The ProSoft Configuration Builder downloads the configuration to the SD Card in the module.
- The module does not transfer the configuration data from the SD card to internal memory. If you remove the SD card and reboot to the module, the module loads the configuration data from the module's memory. If there is no configuration data in the module's memory, the module uses the factory default configuration.

Without an SD Card

- The ProSoft Configuration Builder downloads the configuration to the internal memory of the module. The module uses the configuration from internal memory.
- If you insert a blank SD Card into the module after the module has been configured, the module does not use the configuration on the SD card unless you reboot the module. If you want to copy the configuration to the SD card, you must download the configuration to the module while the SD card is in the module.

1.7 Connecting Power to the Unit

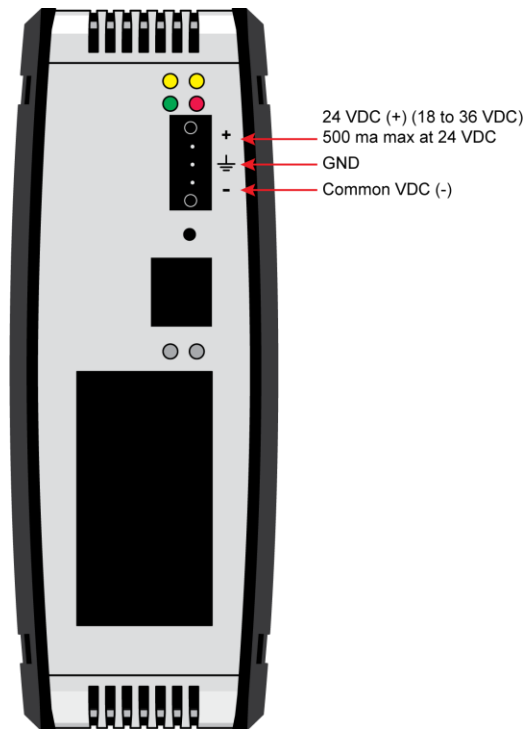

WARNING: Be sure not to reverse polarity when applying power to the gateway. This causes permanent damage to the gateway's internal power distribution circuits.

1.8 Installing ProSoft Configuration Builder Software

You must install the *ProSoft Configuration Builder (PCB)* software to configure the gateway. You can always get the newest version of ProSoft Configuration Builder from the ProSoft Technology website (<http://www.prosoft-technology.com>). The filename contains the version of PCB. For example, **PCB_4.4.3.4.0245.exe**.

To install ProSoft Configuration Builder from the ProSoft Technology website

- 1 Open your web browser and navigate to www.prosoft-technology.com.
- 2 Search for 'PCB' or 'ProSoft Configuration Builder'.
- 3 Click on the ProSoft Configuration Builder search result link.
- 4 From the *Downloads* link, download the latest version of *ProSoft Configuration Builder*.
- 5 Choose **SAVE** or **SAVE FILE**, if prompted.
- 6 Save the file to your *Windows Desktop*, so that you can find it easily when you have finished downloading.
- 7 When the download is complete, locate and open the file, and then follow the instructions on your screen to install the program.

Note: To use the ProSoft Configuration Builder under the Windows 7 OS, you must be sure to install it using the *Run as Administrator* option. To find this option, right-click the Setup.exe program icon, and then click **RUN AS ADMINISTRATOR** on the context menu. You must install using this option even if you are already logged in as an Administrator on your network or personal computer (PC). Using the *Run as Administrator* option allows the installation program to create folders and files on your PC with proper permissions and security.

If you do not use the *Run as Administrator* option, the ProSoft Configuration Builder may appear to install correctly, but you will receive multiple file access errors whenever the ProSoft Configuration Builder is running, especially when changing configuration screens. If this happens, you must completely uninstall the ProSoft Configuration Builder and then re-install using the *Run as Administrator* option to eliminate the errors.

2 Using ProSoft Configuration Builder

ProSoft Configuration Builder (PCB) provides a quick and easy way to manage gateway configuration files customized to meet your application needs. PCB is not only a powerful solution for new configuration files, but also allows you to import information from previously installed (known working) configurations to new projects.

2.1 Connecting the PC to the Gateway

With the module securely mounted, connect one end of the Ethernet cable to the **ETH 1** Port, and the other end to an Ethernet hub or switch accessible from the same network as the PC. Or, connect directly from the Ethernet Port on the PC to the **ETH 1** Port on the module.

2.2 Setting a Temporary IP Address in the Gateway

Important: ProSoft Discovery Service (PDS) locates the gateway through UDP broadcast messages. These messages may be blocked by routers or layer 3 switches. In that case, PDS is unable to locate the gateways.

To use PDS, arrange the Ethernet connection so that there is no router or layer 3 switch between the computer and the gateway OR reconfigure the router or layer 3 switch to allow the routing of the UDP broadcast messages.

- 1 If you have not installed the ProSoft Discovery Service (PDS), refer to Installing the ProSoft Discovery Service.
- 2 Click the Windows **START** button, and then choose **PROGRAMS > PROSOFT TECHNOLOGY > PROSOFT DISCOVERY SERVICE**.
- 3 Right-click module, and then click **ASSIGN TEMPORARY IP**.

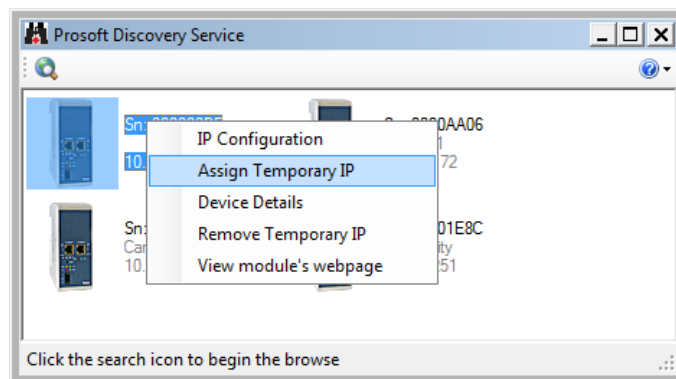

- 4 The module's default IP address is 192.168.0.250.

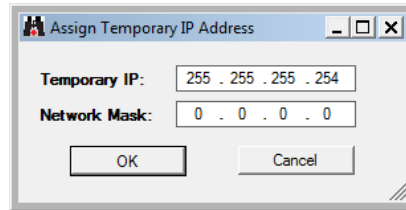

- 5 Enter an unused IP within your subnet, and then click **OK**.
- 6 See *Configuring the Ethernet Port* (page 20) for the steps to set the permanent IP address in the gateway.

2.3 Setting Up the Project

To begin, start ProSoft Configuration Builder (PCB). If you have used other Windows configuration tools before, you will find the screen layout familiar. The ProSoft Configuration Builder (PCB) window consists of a tree view on the left, an information pane, and a configuration pane on the right side of the window. When you first start PCB, the tree view consists of folders for *Default Project* and *Default Location*, with a *Default Module* in the *Default Location* folder. The following illustration shows the PCB window with a new project.

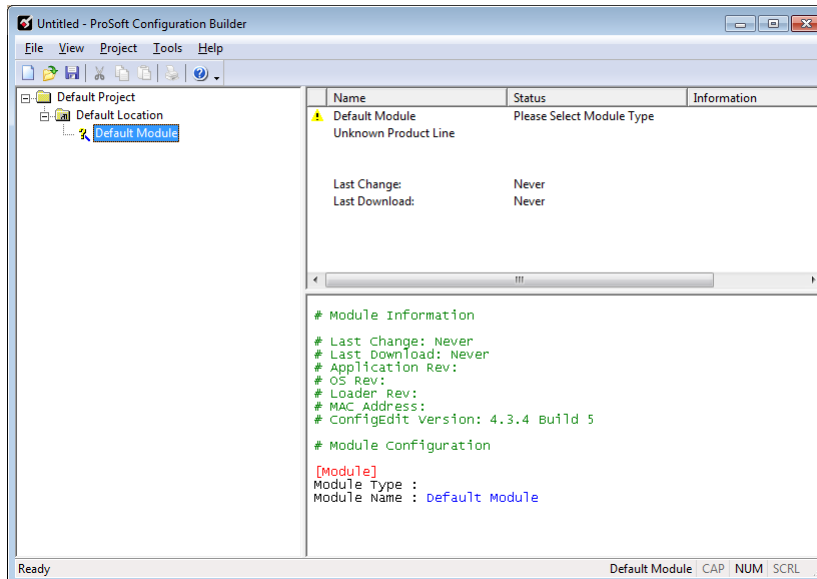

To add the gateway to the project

- 1 Right-click **DEFAULT MODULE** in the tree view, and then choose **CHOOSE MODULE TYPE**. This opens the *Choose Module Type* dialog box.

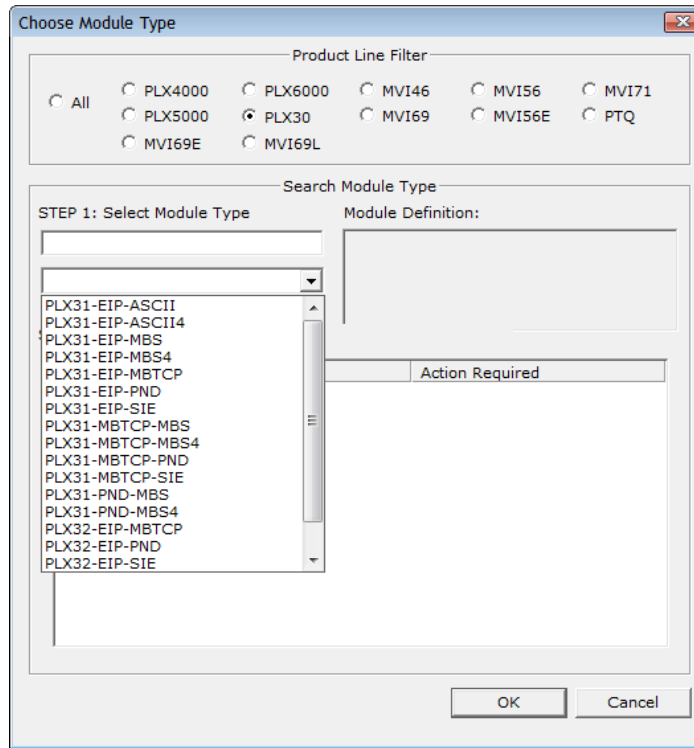

- 2 In the *Product Line Filter* area of the dialog box, select the appropriate product type radio button.
- 3 In the *STEP 1: Select Module Type* dropdown list, select the model number that matches your gateway.
- 4 For some gateways, you can disable one or more ports on the gateway if you do not need them. See *Disabling Gateway Ports* (page 17).
- 5 Click **OK** to save your settings and return to the PCB Main window.

2.4 Disabling Gateway Ports

For some gateways, ProSoft Configuration Builder (PCB) gives you the option to disable one or more ports if you do not need them. Disabling ports can simplify the number of configuration options, making it easier to set up the gateway.

It is easiest to disable ports when you add the gateway to the project in PCB; however, you can enable and disable ports after you have added it to the project. Both methods are described in this topic.

Note: Disabling ports does not affect the performance of the gateway and is not required.

To disable ports on the gateway when you add it to the project

The best time to disable one or more ports on a gateway is when you add the gateway to the project in PCB. See Setting Up the Project (page 16) for the steps to add a gateway. You can disable ports in the *Choose Module Type* dialog box after you select the module you want to add to the project. The following image gives an example.

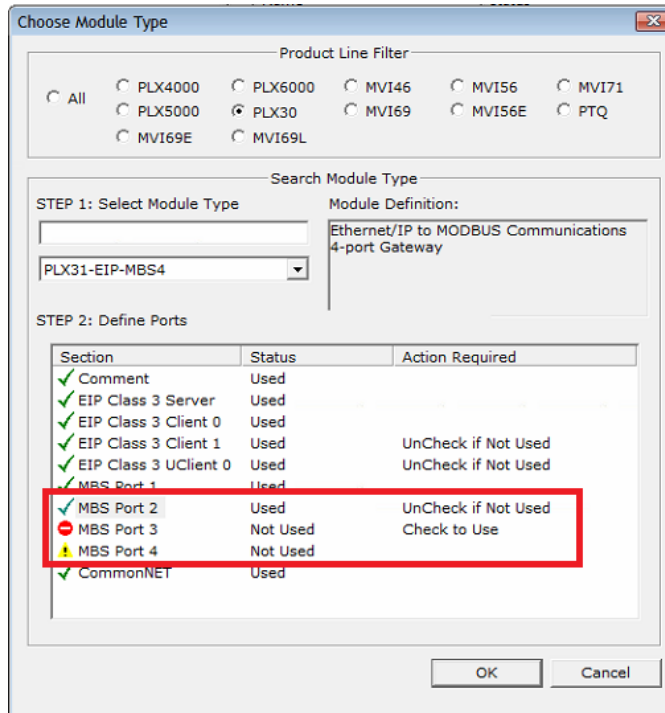

There are two ports disabled. Please note the following:

- Ports that you can disable have **UNCHECK IF NOT USED** in the **ACTION REQUIRED** column.
- Click the port name to disable the port. When you disable a port, a red circle replaces the green checkmark (*MBS Port 3* in this example).
- If there are multiple ports of the same type, only the last one has the *UnCheck if not Used* message (*MBS Port 2*). You can disable and enable ports only in reverse order. In this example, *MBS Port 4* was disabled before *MBS Port 3*.
- If you disable multiple ports of the same type, a yellow triangle replaces the red circle for the port(s) that you disabled first (*MBS Port 4*).
- Finally, if you want to enable a disabled port in this dialog box, click the port name again. Remember that you can enable ports only in order. In this example, you must enable *MBS Port 3* before you can enable *MBS Port 4*.

When you click **OK**, PCB inserts the gateway into the tree view with the disabled configuration options hidden.

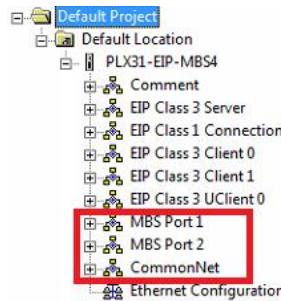

Note that *MBS Port 3* and *MBS Port 4* do not appear in the configuration options for the gateway.

To disable or enable ports on the gateway after you add it to the project

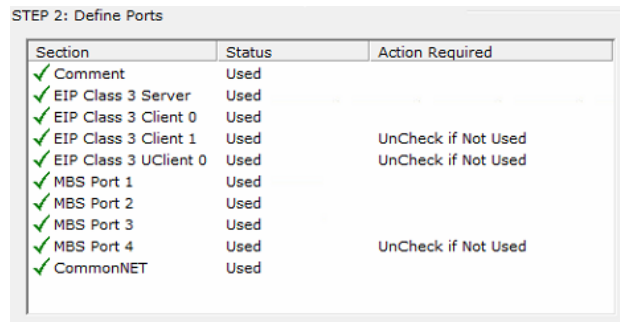

- 1 Right-click the gateway (*PLX31-EIP-MBS4* in this example) in the tree view, and then choose **CHOOSE MODULE TYPE**. This opens the *Choose Module Type* dialog box, with the correct **MODULE TYPE**.



Warning: Note that all of the ports are enabled by default, and that the port state in the *Choose Module Type* dialog box DOES NOT MATCH THE ACTUAL STATE OF THE PORTS. If you want any disabled ports to remain disabled, you must disable them again in this dialog box so that the red circle or yellow triangle appears next to the port name.

- 2 Click the port name to change its status from enabled to disabled, or from disabled to enabled. The same rules noted above still apply. For example, you can disable *MBS Port 3* only if *MBS Port 4* is already disabled.
- 3 When you click **OK**, PCB updates the gateway in the tree view, showing the configuration options for the enabled ports, and hiding the disabled ports.

2.5 Configuring Gateway Parameters

- 1 Click the **[+]** sign next to the module icon to expand gateway information.
- 2 Click the **[+]** sign next to any  icon to view gateway information and configuration options.
- 3 Double-click any  icon to open an *Edit* dialog box.
- 4 To edit a parameter, select the parameter in the left pane and make your changes in the right pane.
- 5 Click **OK** to save your changes.

2.5.1 Renaming PCB Objects

You can rename objects such as the *Default Project* and *Default Location* folders in the tree view. You can also rename the **MODULE** icon to customize the project.

- 1 Right-click the object you want to rename and then choose **RENAME**.
- 2 Type the new name for the object and press **Enter**.

2.5.2 Printing a Configuration File

- 1 In the main PCB window, right-click the **PLX3X GATEWAY** icon and then choose **VIEW CONFIGURATION**.
- 2 In the *View Configuration* dialog box, click the **FILE** menu and click **PRINT**.
- 3 In the *Print* dialog box, choose the printer to use from the drop-down list, select the printing options, and click **OK**.

2.6 Configuring the Ethernet Port

This section shows how to set the Ethernet port parameters for the PLX3x gateway.

To configure the Ethernet port in PCB

- 1 In the ProSoft Configuration Builder tree view, double-click the *Ethernet Configuration* icon.

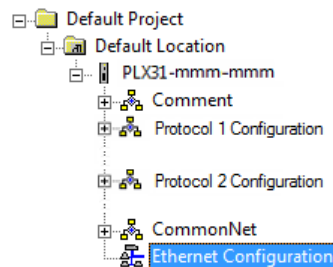

- 2 Click any parameter in the *Edit - WATTCP* dialog box to change the value. If your gateway has two Ethernet ports (PLX32) there are separate configuration options for each port.

Parameter	Description
IP Address	Unique IP address assigned to the module
Netmask	Subnet mask of module
Gateway	Gateway (if used)

Note: Each Ethernet port must be on a different Ethernet subnet.

To determine the protocol for an Ethernet port in PCB (PLX32 only)

- 1 In *ProSoft Configuration Builder*, click the **[+]** next to the gateway, then click the **[+]** next to *Module*.

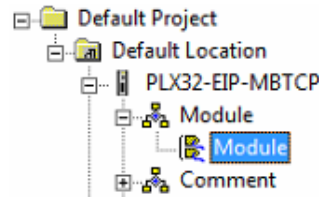

- 2 Double-click the second *Module* icon.
- 3 In the *Edit - Module* dialog box, click the port to see the protocol for that port. You cannot change the protocol assigned to a port.

2.7 Mapping Data in Module Memory

Use the *DATA MAP* section in the ProSoft Configuration Builder to copy data between areas in the gateway's internal database. This allows you to copy data to different addresses within the gateway database in order to create simpler data requests and control. You can use this feature for the following tasks.

- Copy a maximum of 100 registers per Data Map command, and you can configure a maximum of 200 separate copy commands.
- Copy data from the error or status tables in upper memory to internal database registers in the user data area.
- Rearrange the byte and/or word order during the copy process. For example, by rearranging byte or word order, you can convert floating-point values to the correct format for a different protocol.
- Use the Data Map to condense widely dispersed data into one contiguous data block, making it easier to access.

- 1 In the ProSoft Configuration Builder, expand the module tree by clicking the **[+]** next to the module name.
- 2 Click the **[+]** next to **COMMONNET**, and then double-click **DATA MAP**.

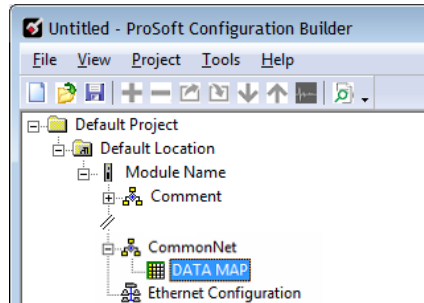

- 3 In the *Edit - Data Map* dialog box, click **ADD ROW**.

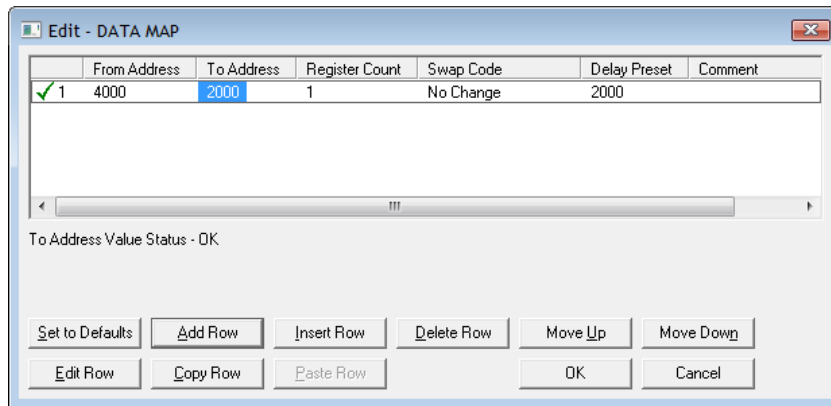

- 4 Click **EDIT ROW** to edit the parameters for the mapping.

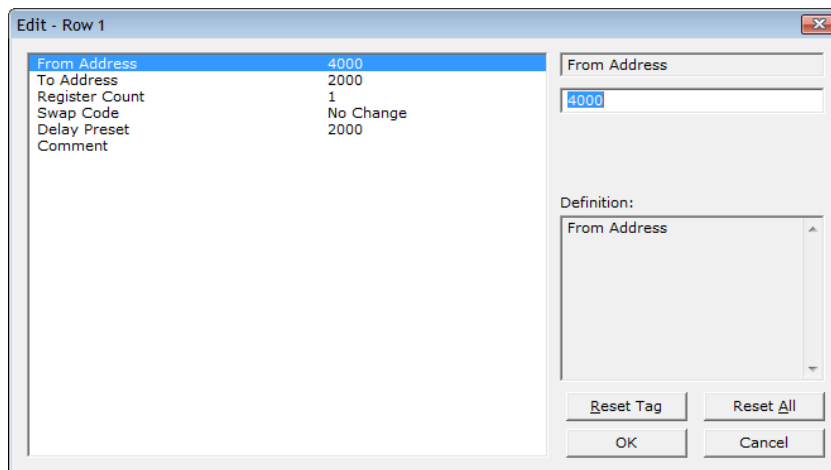

- 5 To change the value of a parameter, click the parameter and enter a new value. Click **OK** when finished.
- 6 Repeat the above steps to add more memory mappings.

2.7.1 From Address

0 to highest *Status Data* address

Specifies the beginning internal database register address for the copy operation. This address can be any valid address in the user data area or the status data area of the gateway.

2.7.2 To Address

0 to 3999

Specifies the beginning destination register address for the copy operation. This address must always be within the user data area. Make sure you specify a destination address that does not overwrite data that is stored in memory by one of the communication protocols running on the gateway.

2.7.3 Register Count

1 to 100

Specifies the number of registers to copy.

2.7.4 Swap Code

NO CHANGE, WORD SWAP, WORD AND BYTE SWAP, BYTE SWAP

You may need to swap the order of the bytes in the registers during the copy process in order to change the alignment of bytes between different protocols. Use this parameter when dealing with floating-point or other multi-register values, because there is no standard for storage of these data types in slave devices.

Swap Code	Description
No Swap	No change is made in the byte ordering (1234 = 1234)
Word Swap	The words are swapped (1234 = 3412)
Word and Byte Swap	The words are swapped, then the bytes in each word are swapped (1234 = 4321)
Bytes	The bytes in each word are swapped (1234 = 2143)

2.7.5 Delay Preset

This parameter sets an interval for each *Data Map* copy operation. The value for the *Delay Preset* is not a fixed amount of time. It is the number of firmware scans that must transpire between copy operations.

The firmware scan cycle can take a variable amount of time, depending on the level of activity of the protocol drivers running on the gateway and the level of activity on the gateway's communication ports. Each firmware scan can take from one to several milliseconds to complete. Therefore, *Data Map* copy operations cannot be expected to happen at regular intervals.

If multiple copy operations (several rows in the *Data map* section) happen too frequently or all happen in the same update interval, they could delay the process scan of the gateway protocols, which could result in slow data updates or missed data on communication ports. To avoid these potential problems, set the *Delay Preset* to different values for each row in the *Data Map* section and set them to higher, rather than lower, numbers.

For example, *Delay Preset* values below 1000 could cause a noticeable delay in data updates through the communication ports. Do not set all *Delay Presets* to the same value. Instead, use different values for each row in the *Data Map* such as 1000, 1001, and 1002 or any other different *Delay Preset* values you like. This prevents the copies from happening concurrently and prevents possible process scan delays.

2.8 Downloading the Project to the Gateway

Note: For instructions on connecting to the module with your PC, see *Connecting the PC to the Gateway* (page 15).

In order for the module to use the settings you configured, you must download (copy) the updated Project file from your PC to the module.

- 1 In the tree view in *ProSoft Configuration Builder*, right-click the **PLX3x GATEWAY** icon and then choose **DOWNLOAD FROM PC TO DEVICE**. This opens the *Download* dialog box.
- 2 In the *Download* dialog box, in the *Select Connection Type* dropdown box, use the default **ETHERNET** option.

Note: If you connected to the module using a temporary IP address, the Ethernet address field contains that temporary IP address. *ProSoft Configuration Builder* uses this temporary IP address to connect to the module.

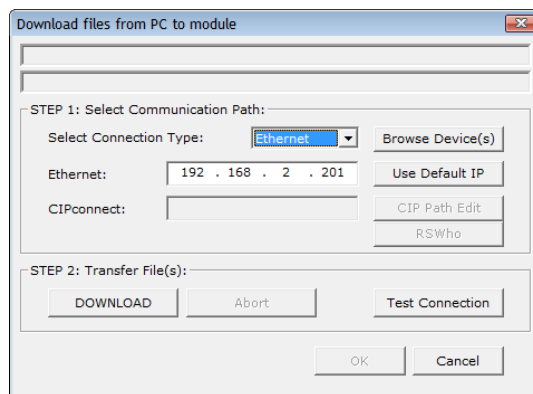

- 3 Click **TEST CONNECTION** to verify that the IP address allows access to the module.
- 4 If the connection succeeds, click **DOWNLOAD** to transfer the Ethernet configuration to the module.

If the *Test Connection* procedure fails, you will see an error message. To correct the error, follow these steps.

- 1 Click **OK** to dismiss the error message.
- 2 In the *Download* dialog box, click **BROWSE DEVICE(S)** to open *ProSoft Discovery Service*.

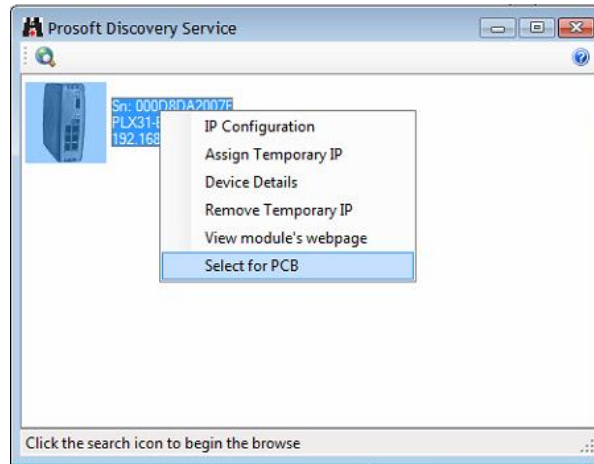

- 3 Right-click the module and then choose **SELECT FOR PCB**.
- 4 Close *ProSoft Discovery Service*.
- 5 Click **DOWNLOAD** to transfer the configuration to the module.

2.9 Uploading the Project from the Gateway

Note: For instructions on connecting to the module with your PC, see *Connecting the PC to the Gateway* (page 15).

You can upload the project settings from the PLX3x gateway into the current project in ProSoft Configuration Builder on your PC.

- 1 In the tree view in *ProSoft Configuration Builder*, right-click the **PLX3x GATEWAY** icon and then choose **UPLOAD FROM DEVICE TO PC**. This opens the *Upload* dialog box.
- 2 In the *Upload* dialog box, in the *Select Connection Type* dropdown box, use the default **ETHERNET** setting.

Note: If you connected to the module using a temporary IP address, the Ethernet address field contains that temporary IP address. *ProSoft Configuration Builder* uses this temporary IP address to connect to the module.

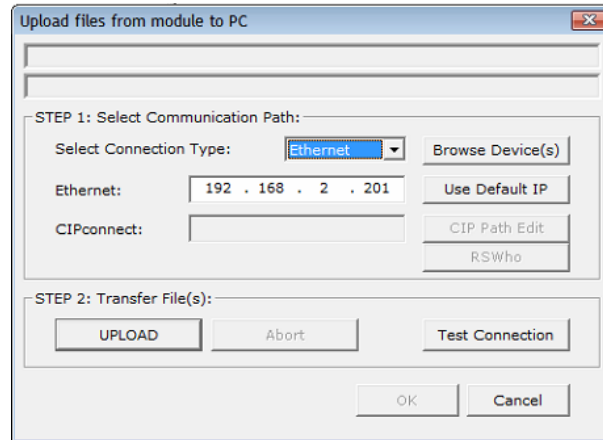

- 3 Click **TEST CONNECTION** to verify that the IP address allows access to the module.
- 4 If the connection succeeds, click **UPLOAD** to transfer the Ethernet configuration to the PC.

If the *Test Connection* procedure fails, you will see an error message. To correct the error, follow these steps.

- 1 Click **OK** to dismiss the error message.
- 2 In the *Upload* dialog box, click **BROWSE DEVICE(S)** to open *ProSoft Discovery Service*.

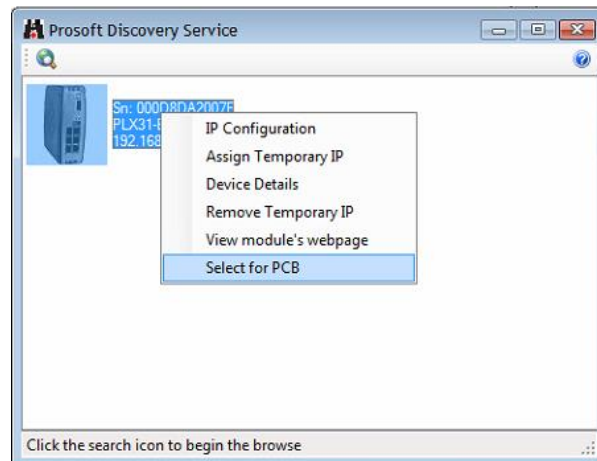

- 3 Right-click the module and then choose **SELECT FOR PCB**.
- 4 Close *ProSoft Discovery Service*.
- 5 Click **DOWNLOAD** to transfer the configuration to the module.

3 Diagnostics and Troubleshooting

In This Chapter

❖ LED Indicators.....	27
❖ Using Diagnostics in ProSoft Configuration Builder.....	29
❖ Gateway Status Data in Upper Memory	36

You can troubleshoot the module using several methods:

- Look at the LED indicators on the gateway.
- Use the Diagnostics functions in ProSoft Configuration Builder (PCB).
- Examine the data in the status data area (upper memory) of the gateway internal memory.

3.1 LED Indicators

The first and quickest is to scan the LEDs on the gateway to determine the existence and possible cause of a problem. The gateway's LEDs provide valuable information such as:

- The state of each port
- System configuration errors
- Application errors
- Fault indications

3.1.1 Main Gateway LEDs

This table describes the gateway front panel LEDs.

LED	State	Description
PWR (Power)	Off	Power is not connected to the power terminals or source is insufficient to properly power the gateway (208 mA at 24 VDC is required).
	Solid Green	Power is connected to the power terminals.
FLT (Fault)	Off	Normal operation.
	Solid Red	A critical error has occurred. Program executable has failed or has been user-terminated and is no longer running. Press the Reset button or cycle power to clear the error.
CFG (Configuration)	Off	Normal operation.
	Solid Amber	The unit is in configuration mode. Either a configuration error exists, or the configuration file is being downloaded or read. After power-up, the gateway reads the configuration, and the unit implements the configuration values and initializes the hardware. This occurs during power cycle or after you press the Reset button.
ERR (Error)	Off	Normal operation.
	Flashing Amber	An error condition has been detected and is occurring on one of the application ports. Check configuration and troubleshoot for communication errors.
	Solid Amber	This error flag is cleared at the start of each command attempt (master/client) or on each receipt of data (slave/adaptor/server). If this condition exists, it indicates a large number of errors are occurring in the application (due to bad configuration) or on one or more ports (network communication failures).
NS (Network Status) for EIP protocol only	Off	No power or no IP address
	Solid Red	Duplicate IP address
	Solid Green	Connected
	Flashing Red	Connection timeout
	Flashing Green	IP address obtained; no established connections
	Alternating Red and Green Flash	Self-test
MS (Module Status) for EIP protocol only	Off	No power
	Solid Red	Major fault
	Solid Green	Device operational
	Flashing Red	Minor fault
	Flashing Green	Standby
	Alternating Red and Green Flash	Self-test

3.1.2 Ethernet Port LEDs

This table describes the gateway Ethernet port LEDs.

LED	State	Description
LINK/ACT	Off	No physical network connection is detected. No Ethernet communication is possible. Check wiring and cables.
	Solid Green	Physical network connection detected. This LED must be ON solid for Ethernet communication to be possible.
100 Mbit	Off	No activity on the port.
	Flashing Amber	The Ethernet port is actively transmitting or receiving data.

3.1.3 Serial Port LEDs (for Gateways with Serial Ports)

This table describes gateway serial port LEDs.

LED	State	Description
RX	Off	No activity on the port.
	Flashing Green	The port is actively receiving data.
TX	Off	No activity on the port.
	Flashing Amber	The port is actively transmitting data.

3.2 Using Diagnostics in ProSoft Configuration Builder

ProSoft Configuration Builder (PCB) has many useful tools to help you with diagnostics and troubleshooting. You can use PCB to connect to your gateway and retrieve current status values, configuration data and other valuable information.

Tip: You can have a ProSoft Configuration Builder Diagnostics window open for more than one gateway at a time.

To connect to the gateway's communication port.

- 1 In PCB, right-click the gateway name and choose **DIAGNOSTICS**.

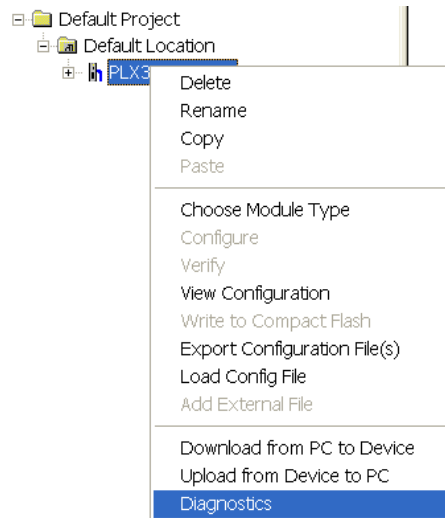

This opens the *Diagnostics* window.

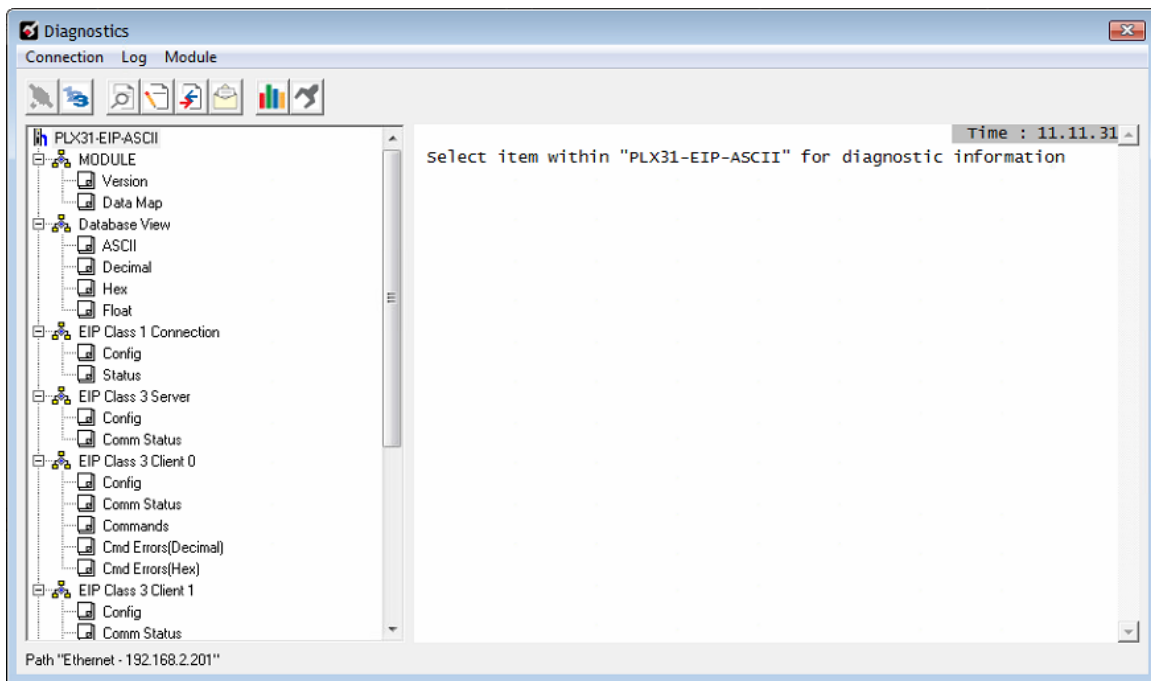

Note: the image above is for a specific version of the PLX3x gateway. The contents of the *Diagnostics* window for your module depends on the protocols supported by the gateway.

See Diagnostics Menu (page 32) for more information. If there is no response from the gateway, as in the example above, follow these steps:

- From the toolbar, click the **SETUP CONNECTION** button.

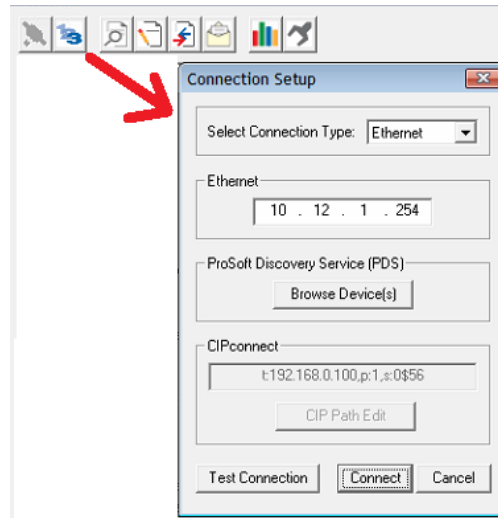

- In the *Connection Setup* dialog box, select **ETHERNET** from the **SELECT CONNECTION TYPE** list.
- Type in the gateway's IP address in the **ETHERNET** field.
- Click **CONNECT**.
- Verify that the Ethernet is connected properly between your computer's communication port and the gateway.
- If you are still not able to establish a connection, contact ProSoft Technology Technical Support for assistance.

3.2.1 Diagnostics Menu

The Diagnostics menu is arranged as a tree structure in the left side of the *Diagnostics* window. The available menu commands depend on the protocols supported in your PLX3x gateway.

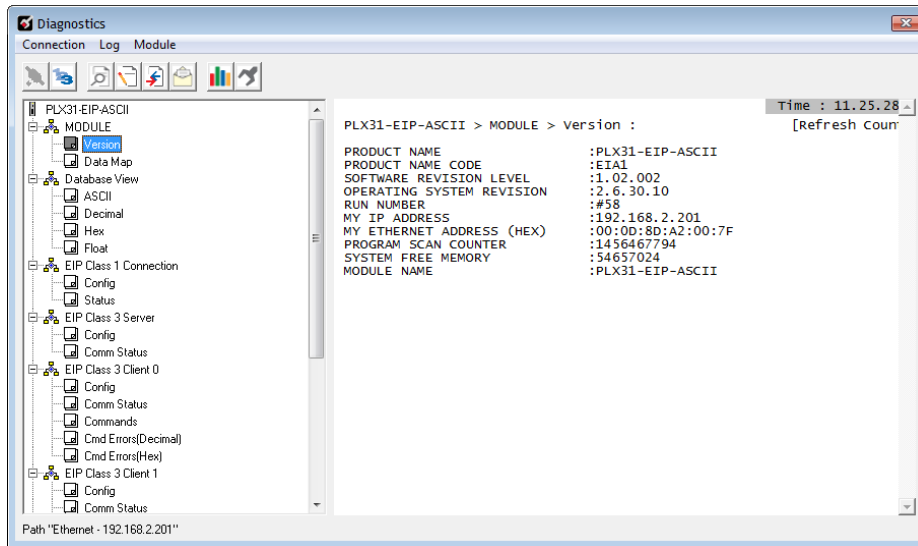

Caution: Some of the commands from this menu are designed for advanced debugging and system testing only, and can cause the gateway to stop communicating, potentially resulting in data loss or other communication failures. Use these commands only if you fully understand their potential effects, or if you are specifically directed to do so by ProSoft Technology Technical Support engineers.

The following menu commands are common to all PLX3x gateways:

Menu Command	Submenu Command	Description
Module	Version	Displays the gateway's current software version and other important values. You may be asked to provide this information when calling for technical support.
	Data Map	Displays the gateway's Data Map configuration.
Database View	ASCII	Displays the contents of the gateway's database in ASCII character format.*
	Decimal	Displays the contents of the gateway's database in decimal number format.*
	Hex	Displays the contents of the gateway's database in hexadecimal number format.*
	Float	Displays the contents of the gateway's database in floating-point number format.*

*Use the scroll bar on the right edge of the window to navigate through the database. Each page displays 100 words of data. The total number of pages available depends on your gateway's configuration.

3.2.2 Capturing a Diagnostic Session to a Log File

You can capture anything you do in a Diagnostics session to a log file. This feature can be useful for troubleshooting and record-keeping purposes, and for communication with ProSoft Technology's Technical Support team.

To capture session data to a log file

- 1 Open a *Diagnostics* window. See Using Diagnostics in ProSoft Configuration Builder (page 29).
- 2 To log a Diagnostics session to a text file, from the toolbar, click the **LOG FILE** button. Click the button again to stop the capture.



- 3 To view the log file, from the toolbar, click the **VIEW LOG FILE** button. The log file opens as a text file, which you can rename and save to a different location.



- 4 To email the log file to ProSoft Technology's Technical Support team, from the toolbar, click the **EMAIL LOG FILE** button. This only works if you have installed Microsoft Outlook on your PC.)

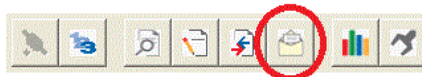

- 5 If you capture multiple sequential sessions, PCB appends the new data to the end of the previously captured data. If you want to clear the previous data from the log file, you must click the **CLEAR DATA** button each time before you start capturing data.



3.2.3 Using the Data Analyzer (Serial Protocols Only)

The Data Analyzer is an extremely valuable troubleshooting tool available in ProSoft Configuration Builder. It allows you to "see" the data packets entering and leaving the serial ports on the gateway. You can also capture this data to a log file.

Note: The PCB Data Analyzer is for serial ports only. To analyze data traffic on an Ethernet port, ProSoft Technology recommends using a network protocol analyzer available on the Internet, such as Wireshark.

To use the Data Analyzer

- 1 Open a *Diagnostics* window. See Using Diagnostics in ProSoft Configuration Builder (page 29).
- 2 From the toolbar, click the **SETUP DATA ANALYZER** button.



- 3 In the *Data Analyzer Setup* dialog box, specify the time tick interval, the serial port number, and whether the data packet contents should be displayed in hexadecimal number or ASCII character format. Click **OK**.

Note: The time tick is a symbol (`_TT_`) displayed on the *Data Analyzer* screen that allows you to estimate time intervals during a Data Analyzer session. The time tick prints at the time interval you choose in the *Data Analyzer Setup* dialog box. For example, if you select 10 mS Ticks, it prints `_TT_` every 10 milliseconds.

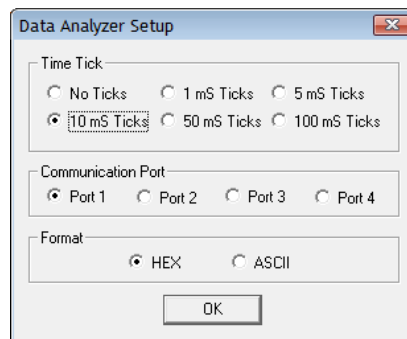

- 4 If you wish to capture the Data Analyzer session to a log file, from the toolbar, click the **LOG FILE** button.



3.2.4 Warm Boot / Cold Boot

Warm and Cold booting the PLX3x gateway can be done by clicking **MODULE > GENERAL > WARM BOOT** or **COLD BOOT**.

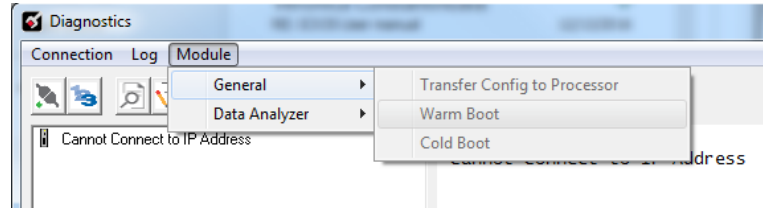

3.3 Gateway Status Data in Upper Memory

The gateway writes useful module status data in dedicated upper memory locations in its internal database. The location of this status data area depends on the protocols supported by your gateway. You can use the Data Map function in Prosoft Configuration Builder to map this data into the user data area of the gateway's database (registers 0 through 3999). Remote devices, such as HMIs or processors can then access the status data. See Mapping Data in Module Memory (page 21).

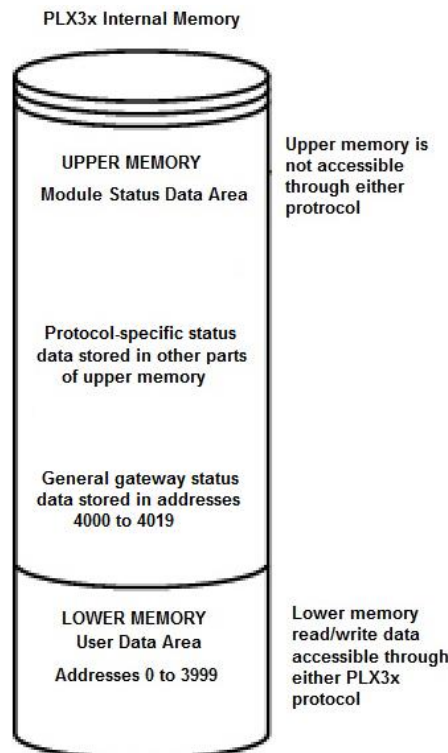

3.3.1 General Gateway Status Data in Upper Memory

The following table describes the contents of the gateway's general status data area.

Register Address	Description
4000 through 4001	Program Cycle Counter
4002 through 4004	Product Code (ASCII)
4005 through 4009	Product Revision (ASCII)
4010 through 4014	Operating System Revision (ASCII)
4015 through 4019	OS Run Number (ASCII)

3.3.2 Protocol-Specific Status Data in Upper Memory

The PLX3x gateway also has upper memory locations for protocol-specific status data. The location of the status data area for the gateway protocol drivers depend on the protocols. For more information, see:

- EIP Status Data in Upper Memory (page 67)
- MBTCP Status Data in Upper Memory (page 104)
- MBS Status Data in Upper Memory (page 123)
- ASCII Status Data in Upper Memory (page 144)
- SIE Status Data in Upper Memory (page 167)
- PND Status Data in Upper Memory (page 201)

4 Hardware Information

In This Chapter

- ❖ EIP Functional Overview 39
- ❖ Serial Port Cables (for Gateways with Serial Ports) 40

4.1 Hardware Specifications

Specification	Description
Power Supply	24 VDC nominal 10 VDC to 36 VDC allowed Positive, Negative, GND Terminals
Current Load	208 mA normal @ 24 VDC normal 300 mA maximum @ 36 VDC maximum
Operating Temperature	-25°C to 70°C (-13°F to 158°F)
Storage Temperature	-40°C to 80°C (-40°F to 176°F)
Relative Humidity	5% to 95% RH with no condensation
Dimensions (H x W x D)	5.38 x 1.99 x 4.38 in 13.67 x 5.05 x 11.13 cm
LED Indicators (On all gateways)	<ul style="list-style-type: none"> ▪ Configuration (CFG) and Error (ERR) Communication Status ▪ Power (PWR) and Hardware Fault (FLT) ▪ Network Status (NS) EtherNet/IP™ Class I or Class III Connection Status (EtherNet/IP Only) ▪ Module Status (MS) Module Configuration Status (EtherNet/IP Only) ▪ Ethernet Communication Port Link/Activity and 100 mbit ▪ Serial Communication Port Receive (RX) and Transmit (TX)
Ethernet Port(s)	10/100 Mbit full-duplex RJ45 Connector Electrical Isolation 1500 Vrms at 50 Hz to 60 Hz for 60 seconds, applied as specified in section 5.3.2 of IEC 60950: 1991 Ethernet Broadcast Storm Resiliency = less than or equal to 5000 [ARP] frames-per-second and less than or equal to 5 minutes duration
Serial Port Isolation	2500 Vrms port signal isolation per UL 1577 serial port communication signal uses RF (Radio Frequency) modulation signal as isolation media, IC chip model is Silicon Labs Si844x (Si8440,Si8441,Si8442).
Shipped With Each Unit	2.5 mm screwdriver J180 Power Connector (1 to 4) RJ45-DB9M Serial Adapter Cable (serial protocol only) (1 to 4) DB9 to Screw Terminal Adapter (serial protocol only)

4.1.1 Serial Port Specifications

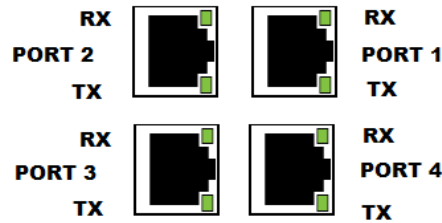

Type	Specifications
Serial Port Isolation	2500 Vrms port signal isolation per UL 1577 serial port communication signal uses RF (Radio Frequency) modulation signal as isolation media, IC chip model is Silicon Labs Si844x (Si8440, Si8441, Si8442).
Serial Port Protection	RS-485/422 port interface lines TVS diode protected at +/- 27V standoff voltage. RS-232 port interface lines fault protected to +/- 36V power on, +/- 40V power off.

4.2 Serial Port Cables (for Gateways with Serial Ports)

This section contains information on the cable and pinout assignments for the PLX3x gateway's serial ports (RS-232/422/485). The PLX3x gateway may come with one or four serial ports, depending on the configuration purchased.

Note:

The PLX31-EIP-MBS4 gateway contains four serial communication ports.

The PLX31-EIP-MBS gateway contains one serial communication port.

Each physical serial port has a RJ45 jack connector. A six-inch RJ45 to DB9 Male adapter cable is provided for each serial port. The DB9 Male adapter cable provides connections for RS-232, wired as Data Terminal Equipment (DTE), RS-422 and RS-485.

4.2.1 Serial Port Specifications

This type of connection is used when the device connected to the gateway requires hardware handshaking (control and monitoring of modem signal lines). To enable hardware handshaking, set the port configuration to use RTS/CTS handshaking. (For MBS protocol, set the *Use CTS Line* parameter to **Yes**. For ASCII protocol, set the Handshaking parameter to **Yes**).

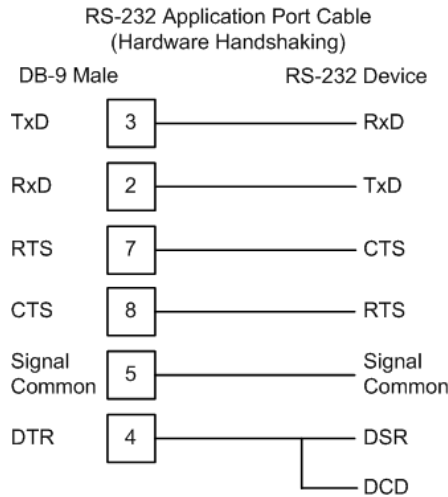

4.2.2 RS-232 - Null Modem (DTE without Hardware Handshaking)

This type of connection can be used to connect the gateway to a computer or field device communication port.

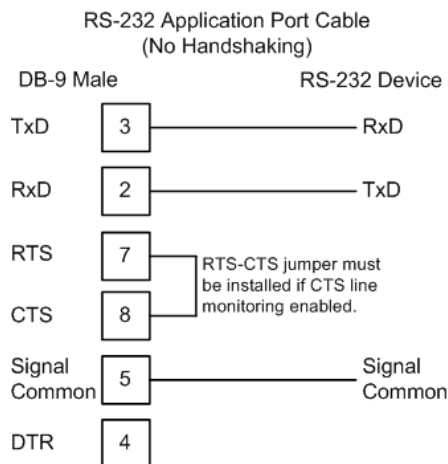

Note: If the port is configured to use RTS/CTS handshaking, then a jumper is required between the RTS and the CTS line on the gateway connection.

4.2.3 RS-232 - DTE to DCE Modem Connection

This type of connection is required between the gateway and a modem or other communication device.

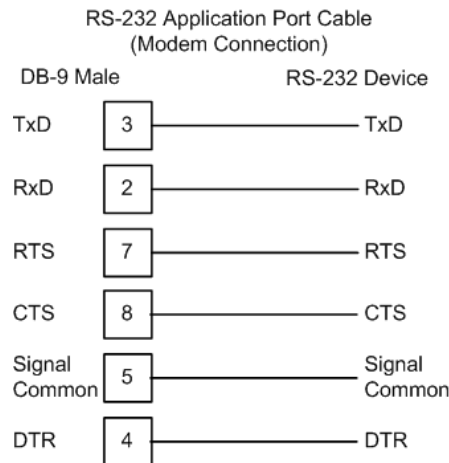

For most modem applications, RTS/CTS handshaking should be enabled in the port configuration.

4.2.4 RS-422 Interface Connections

The following illustration applies when the RS-422 interface is selected.

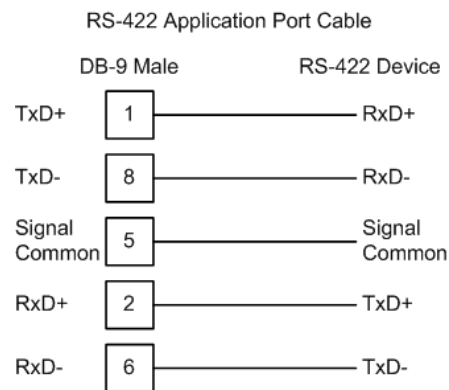

4.2.5 RS-485 Interface Connection

The following illustration applies when the RS-485 interface is selected.

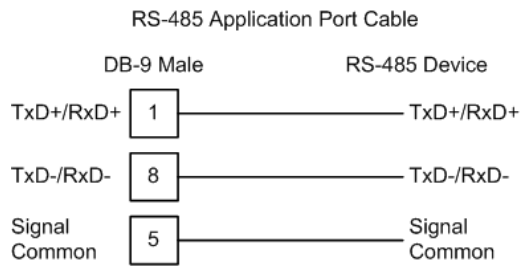

NOTE: This type of connection is commonly called a RS-485 half-duplex, 2-wire connection. If you have RS-485 4-wire, full-duplex devices, they can be connected to the gateway's serial ports by wiring together the TxD+ and RxD+ from the two pins of the full-duplex device to Pin 1 on the gateway and wiring together the TxD- and RxD- from the two pins of the full-duplex device to Pin 8 on the gateway. As an alternative, you could try setting the gateway to use the RS-422 interface and connect the full-duplex device according to the RS-422 wiring diagram. For additional assistance, please contact ProSoft Technical Support.

5 EIP Protocol

In This Chapter

- ❖ EIP Functional Overview 45
- ❖ EIP Configuration 49
- ❖ Network Diagnostics..... 66
- ❖ EIP Reference 72

5.1 EIP Functional Overview

You can use the PLX3x gateway EIP gateway to interface many different protocols into the Rockwell Automation family of processors, or other software-based solutions.

The following illustration shows the functionality of the EtherNet/IP protocol.

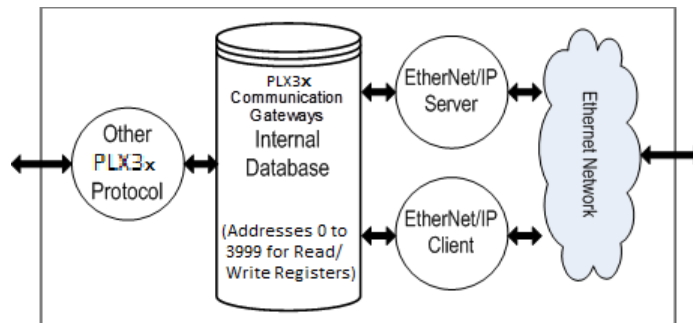

5.1.1 EtherNet/IP General Specifications

The EIP driver supports the following connections:

Class	Connection Type	Number of Connections
Class 1	I/O	Depends on the gateway model: PLX3x-EIP-MBTCP - 2 connections PLX3x-EIP-MBS - 2 connections PLX3x-EIP-MBS4 - 8 connections PLX3x-EIP-ASCII - 1 connection PLX3x-EIP-ASCII4 - 4 connections PLX3x-EIP-SIE - 2 connections PLX3x-EIP-PND - 8 connections
Class 3	Connected Client	2
	Unconnected Client	1
	Server	5

Supported PLC Types	PLC2, PLC5, SLC, CLX, Cmplx, MICROLX
Supported Message Types	PCCC and CIP
I/O connection sizes in/out	496/496 bytes
Max RPI time	5 ms per connection
CIP Services Supported	0x4C - CIP Data Table Read 0x4D - CIP Data Table Write CIP Generic
Command List	Supports up to 100 commands per client. Each command is configurable for command type, IP address, register to/from address, and word/bit count.
Command Sets	PLC-2/PLC-3/PLC5 Basic Command Set PLC5 Binary Command Set PLC5 ASCII Command Set SLC500 Command Set

5.1.2 EIP Internal Database

The internal database is central to the functionality of the PLX3x gateway. The gateway shares this database between all the communications ports on the gateway and uses it as a conduit to pass information from one protocol to another device on one network to one or more devices on another network. This permits data from devices on one communication port to be accessed and controlled by devices on another communication port.

In addition to data from the client and server, you can map status and error information generated by the gateway into the user data area of the internal database. The internal database is divided into two areas:

- Upper memory for the module status data area. This is where the module writes internal status data for the protocols supported by the module.
- Lower memory for the user data area. This is where incoming data from external devices is stored and accessed.

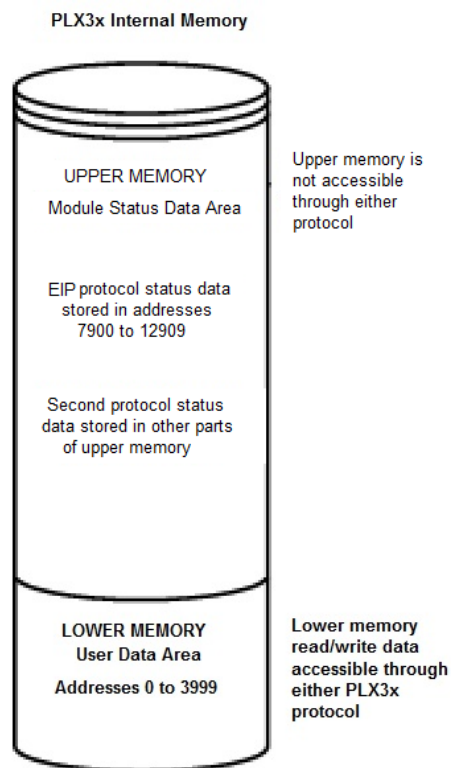

Either protocol in the PLX3x gateway can write data to and read data from the user data area.

- If the module is acting as a client/master, you create commands to read data from external client/server devices and store the data in a specific location in the user data area.
- If the module is acting as a server/slave, the external client/master devices write data to a specific location in the user data area.

Note: If you want to access module status data in the upper memory, you can use the data mapping feature in the gateway to copy data from the module status data area to the user data area. See Mapping Data in Module Memory (page 21). Otherwise, you can use the diagnostic functions in ProSoft Configuration Builder to view module status data. For more information on the module status data, see Network Diagnostics (page 66).

EIP Client Access to Database

The client functionality exchanges data between the 's internal database and data tables established in one or more processors or other server based devices. The command list that you define in ProSoft Configuration Builder specifies what data is to be transferred between the gateway and each of the servers on the network. No ladder logic is required in the processor (server) for client functionality, except to assure that sufficient data memory exists.

The following illustration describes the flow of data between the Ethernet clients and the internal database.

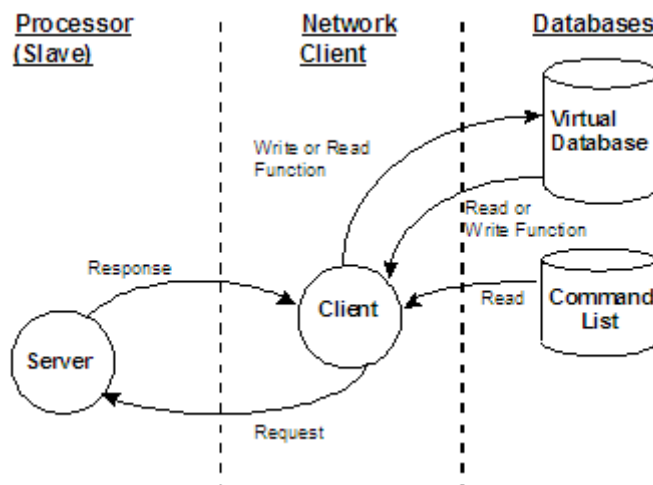

Multiple Server Access to EIP Database

Server support in the gateway allows client applications (such as HMI software and processors) to read from and write to the gateway's database. The server driver is able to support multiple concurrent connections from several clients.

When configured as a server, the user data area of the internal database in the gateway is the source for read requests and the destination for write requests from remote clients. Access to the database is controlled by the command type received in the incoming message from the client.

The gateway must be correctly configured and connected to the network before any attempt is made to use it. Use a network verification program, such as *ProSoft Discovery Service* or the command prompt PING instruction, to verify that the gateway can be seen on the network. Use *ProSoft Configuration Builder* to confirm proper configuration of the gateway and to transfer the configuration files to and from the gateway.

5.2 EIP Configuration

5.2.1 Configuring EIP Class 3 Server

Use the *EIP Class 3 Server* connection in ProSoft Configuration Builder when the gateway is acting as a server (slave) device responding to message instructions initiated from a client (master) device such as an HMI, DCS, PLC, or PAC.

To set the server file size in PCB

- 1 In ProSoft Configuration Builder, click the **[+]** next to the gateway, then click the **[+]** next to *EIP Class 3 Server*.

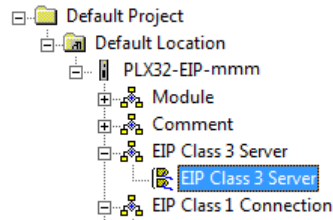

- 2 Double-click the second *EIP Class 3 Server* to display the *Edit - EIP Class 3 Server* dialog box.
- 3 Select the **SERVER FILE SIZE** (100 or 1000).
 - For a value of 100, the registers are from N10:0 to N10:99.
 - For a value of 1000, the valid registers are from N10:0 to N10:999.

Accessing the Gateway's Internal Memory

The following table refers to the user data area in the module's memory:

Data Type	Tag Name	Length of Each Element in CIP Message	Array Range for 4000 Element Database
BOOL	BOOLData[]	1	0 to 63999
Bit Array	BITAData[]	4	0 to 1999
SINT	SINTData[]	1	0 to 7999
INT	INT_Data[]	2	0 to 3999
DINT	DINTData[]	4	0 to 1999
REAL	REALData[]	4	0 to 1999

MSG Instruction Type - CIP

The following table defines the relationship of the user data area in the gateway's internal database to the addresses required in the MSG CIP instructions:

Data-base Address	CIP Integer	CIP Boolean	CIP Bit Array	CIP Byte	CIP DINT	CIP Real
0	Int_data [0]	BoolData[0]	BitAData[0]	SIntData[0]	DIntData[0]	RealData [0]
999	Int_data [999]	BoolData[15984]		SIntData[1998]		
1000	Int_data [1000]	BoolData[16000]	BitAData[500]	SIntData[2000]	DIntData[500]	RealData [500]
1999	Int_data [1999]	BoolData[31984]		SIntData[3998]		
2000	Int_data [2000]	BoolData[32000]	BitAData[1000]	SIntData[4000]	DIntData[1000]	RealData [1000]
2999	Int_data [2999]	BoolData[47984]		SIntData[5998]		
3000	Int_data [3000]	BoolData[48000]	BitAData[1500]	SIntData[6000]	DIntData[1500]	RealData [1500]
3999	Int_data [3999]	BoolData[63999]		SIntData[9998]		

MSG Instruction Type - PCCC

The following table defines the relationship of the user data area in the gateway's internal database to the addresses required in the MSG PCCC instructions:

Database Address	File size 100	Database Address	File size 100
0	N10:0	0	N10:0
999	N19:99	999	N19:99
1000	N20:0	1000	N20:0
1999	N29:99	1999	N29:99
2000	N30:0	2000	N30:0

EtherNet/IP Explicit Messaging Server Command Support

The PLX3x gateway supports several command sets.

Basic Command Set Functions

Command	Function	Definition	Supported in Server
0x00	N/A	Protected Write	X
0x01	N/A	Unprotected Read	X
0x02	N/A	Protected Bit Write	X
0x05	N/A	Unprotected Bit Write	X
0x08	N/A	Unprotected Write	X

PLC-5 Command Set Functions

Command	Function	Definition	Supported in Server
0x0F	0x00	Word Range Write (Binary Address)	X
0x0F	0x01	Word Range Read (Binary Address)	X
0x0F		Typed Range Read (Binary Address)	X
0x0F		Typed Range Write (Binary Address)	X
0x0F	0x26	Read-Modify-Write (Binary Address)	
0x0F	0x00	Word Range Write (ASCII Address)	X
0x0F	0x01	Word Range Read (ASCII Address)	X
0x0F	0x26	Read-Modify-Write (ASCII Address)	

SLC-500 Command Set Functions

Command	Function	Definition	Supported in Server
0x0F	0xA1	Protected Typed Logical Read With Two Address Fields	X
0x0F	0xA2	Protected Typed Logical Read With Three Address Fields	X
0x0F	0xA9	Protected Typed Logical Write With Two Address Fields	X
0x0F	0xAA	Protected Typed Logical Write With Three Address Fields	X
0x0F	0xAB	Protected Typed Logical Write With Mask (Three Address Fields)	

5.2.2 Configuring EIP Class 1 Connection

Use the *EIP Class 1 Connection* in ProSoft Configuration Builder when the gateway acts as an EIP adapter transferring data to and from a PLC (the EIP scanner) using a direct I/O connection. Direct I/O connections can transfer large amounts of data quickly.

The PLX3x EIP gateway can handle up to eight I/O connections (depending on the model), each with 248 words of input data and 248 words of output data.

Adding the Gateway to RSLogix5000 v.20

- 1 Start Rockwell Automation RSLinx and browse to the PLX3x gateway.
- 2 Right-click the gateway and then choose **UPLOAD EDS FROM DEVICE**.

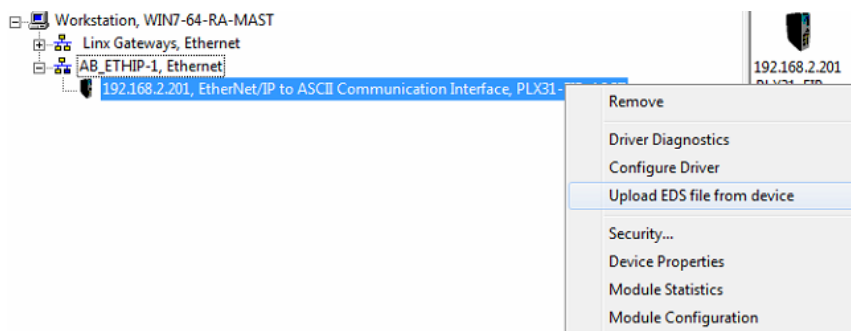

Note: RSLogix5000 may need to be restarted in order to complete the EDS installation.

- 3 After you restart RSLogix 5000, open the desired RSLogix 5000 project.
- 4 In the *Controller Organizer*, right-click the EtherNet/IP bridge in the I/O tree and choose **NEW MODULE**.

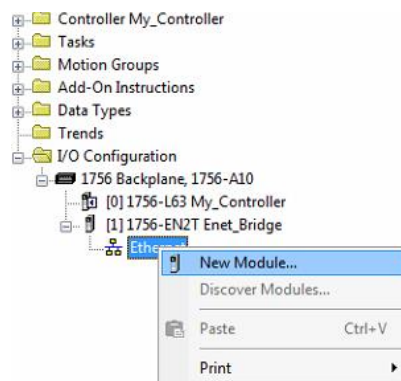

- 5 In the *Select Module Type* dialog box, in the *Enter search text* box, type PLX3.

- 6 Click your PLX3x gateway, and then click **CREATE**. This opens the *New Module* dialog box.

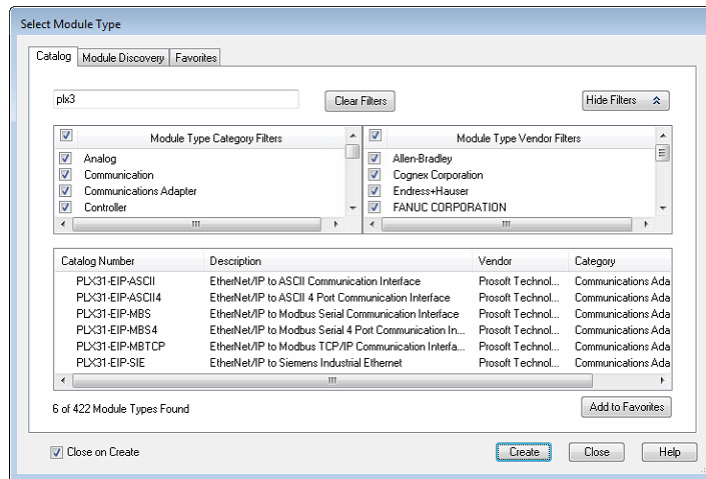

- 7 In the *New Module* dialog box, enter a name for the gateway, then enter the IP address of the PLX3x gateway.

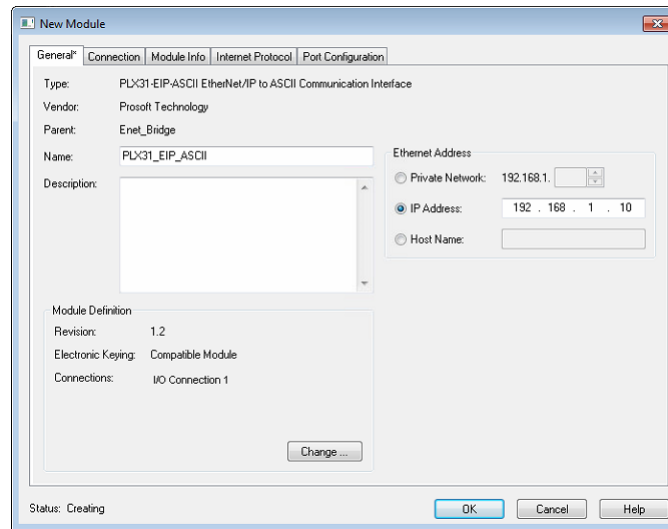

- 8 To add I/O connections click **CHANGE**.

- 9 In the *Module Definition* dialog box, enter the I/O connections.

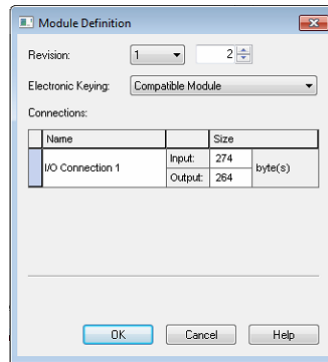

- 10 You can add up to eight I/O connections (depending on the PLX3x module). The I/O connections have a fixed size of 496 bytes of input data and 496 bytes of output data. When finished click **OK**.
- 11 In the *Module Properties* dialog box, click the **CONNECTION** tab to configure each I/O connection with its own RPI time. When finished, click **OK**. The new gateway appears in the *Controller Organizer* under the EtherNet/IP bridge.

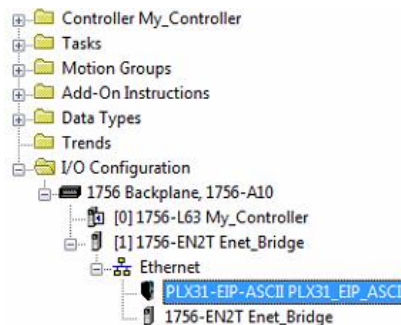

Adding the Gateway to RSLogix5000 v.16 through v.19

Note: Class 1 connections are not supported in RSLogix v.15 and older

- 1 Start Rockwell Automation RSLogix 5000.
- 2 In the *Controller Organizer*, right-click the EtherNet/IP bridge in the I/O tree and choose **NEW MODULE**.
- 3 In the *Select Module Type* dialog box, click **FIND**. Search for *Generic EtherNet Bridge*, click *Generic Ethernet Bridge*, and then click **CREATE**.
- 4 In the *New Module* dialog box, enter a name for the gateway, then enter the IP address of the PLX3x gateway. This creates the communication path from the processor to the PLX3x gateway.

- 5 Add a new module under the *Generic EtherNet Bridge* and add a CIP Connection (*CIP-MODULE*). Here is where you specify the parameters for the I/O connection. The input and output sizes need to match the input and output sizes configured in PCB. The **ADDRESS** field value represents the connection number in PCB. By default all of the connections have 248 Input words, 248 Output words, and 0 Configuration words. Set the Comm format to Data type INT, and set the Assembly instances to be "1" for input, "2" for output, and "4" for configuration.
- 6 Add and configure a CIP Connection for each I/O connection.

Configuring EIP Class 1 Connections in PCB

After you have created the PLX3x module in RSLogix 5000, you must configure the connections in the module.

To configure Class 1 connections in PCB

- 1 In *ProSoft Configuration Builder*, click the **[+]** next to the gateway, then click the **[+]** next to *EIP Class 1 Connection [x]*. The value of [x] depends on the number of ports on your PLX3x gateway (1 to 4).

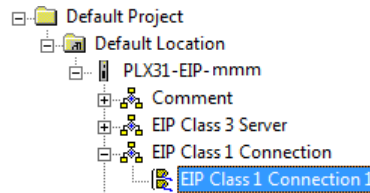

- 2 Double-click the *EIP Class 1 Connection [x]* to display the *Edit - EIP Class 1 Connection [x]* dialog box.
- 3 In the dialog box, click a parameter and then enter a value for the parameter. There are four configurable parameters for each I/O connection in ProSoft Configuration Builder.

Parameter	Value Range	Description
Input Data Address	0 to 3999	Specifies the starting address within the gateway's virtual database for data transferred from the gateway to the PLC.
Input Size	0 to 248	Specifies the number of Integers being transferred to the PLC's input image (248 integers max).
Output Data Address	0 to 3999	Specifies the starting address within the gateway's virtual database for data transferred from the PLC to the gateway.
Output Size	0 to 248	Specifies the number of integers being transferred to the PLC's output image (248 integers max).

5.2.3 Configuring EIP Class 3 Client[x]/UClient Connection

The PLX3x gateway supports two connected clients and one unconnected client (most devices use connected clients; be sure refer to the user manual for the target device for verification).

- Use the *EIP Class 3 Client [x]* connections when the gateway is acting as a client/master initiating message instructions to the server/slave devices. The PLX3x EIP protocol supports three connected client connections. Typical applications include SCADA systems, and SLC communication.
- Use the *EIP Class 3 UClient* connection when the gateway is acting as a client/master initiating message instructions to the server/slave devices. The PLX3x EIP protocol supports one unconnected client connection. Unconnected messaging is a type of EtherNet/IP explicit messaging that uses TCP/IP implementation. Certain devices, such as the AB Power Monitor 3000 series B, support unconnected messaging. Check your device documentation for further information about its EtherNet/IP implementation.

Class 3 Client[x]/UClient

To configure Class 3 Client/UClient [x] connections

- 1 In ProSoft Configuration Builder, click the **[+]** next to the gateway, then click the **[+]** next to *EIP Class 3 Client [x]* or *EIP Class 3 UClient [x]*.

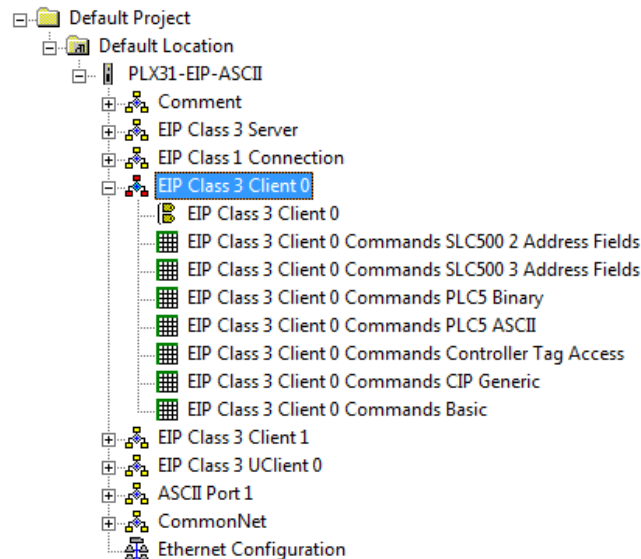

- 2 Double-click the second *EIP Class 3 Client [x]* to display the *Edit - EIP Class 3 Client [x]* dialog box.
- 3 In the dialog box, click any parameter to change its value.

The following table specifies the configuration for the EIP client (master) device on the network port:

Parameter	Value	Description
Minimum Command Delay	0 to 65535 milliseconds	Specifies the number of milliseconds to wait between the initial issuances of a command. This parameter can be used to delay all commands sent to servers to avoid "flooding" commands on the network. This parameter does not affect retries of a command as they will be issued when failure is recognized.
Response Timeout	0 to 65535 milliseconds	Specifies the amount of time in milliseconds that a Client will wait before re-transmitting a command if no response is received from the addressed server. The value to use depends on the type of communication network used, and the expected response time of the slowest device connected to the network.
Retry Count	0 to 10	Specifies the number of times a command will be retried if it fails.

Class 3 Client[x]/UClient Commands

There is a separate command list for each of the different message types supported by the protocol. Each list is processed from top to bottom, one after the other, until all specified commands are completed, and then the polling process begins again.

This section defines the EtherNet/IP commands to be issued from the gateway to server devices on the network. You can use these commands for data collection and control of devices on the TCP/IP network. In order to interface the virtual database with Rockwell Automation Programmable Automation Controllers (PACs), Programmable Logic Controllers (PLCs), or other EtherNet/IP server devices, you must construct a command list, using the command list parameters for each message type.

To add Class 3 Client/UClient [x] commands

- 1 In ProSoft Configuration Builder, click the **[+]** next to the gateway, then click the **[+]** next to *EIP Class 3 Client [x]* or *EIP Class 3 UClient [x]*.

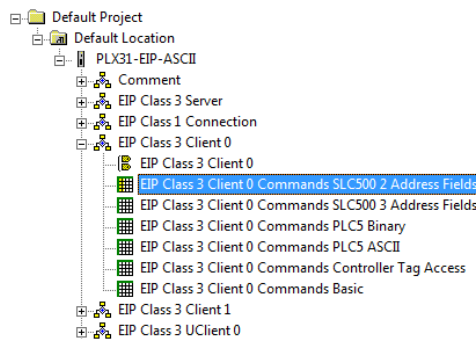

- 2 Double-click the desired command type to display the *Edit - EIP Class 3 Client [x] Commands* or *Edit - EIP Class 3 UClient [x] Commands* dialog box.
- 3 Click **ADD ROW** to add a new command.
- 4 Click **EDIT ROW** or double-click the row to display the *Edit* dialog box where you configure the command.

Class 3 Client/UClient [x] Commands SLC500 2 Address Fields

Parameter	Value	Description
Enable	Enable Disable Conditional Write	Specifies if the command should be executed and under what conditions. ENABLE - The Command is executed each scan of the command list DISABLE - The command is disabled and will not be executed CONDITIONAL WRITE - The Command executes only if the internal data associated with the command changes
Internal Address	0 to 3999	Specifies the database address in the modules internal database to be associated with the command. If the command is a read function, the data received in the response message is placed at the specified location. If the command is a write function data used in the command is sourced from specified data area.
Poll Interval	0 to 65535	Specifies the minimum interval to execute continuous commands. The parameter is entered in 1/10 of a second. If a value of 100 is entered for a command, the command executes no more frequently than every 10 seconds.
Reg Count	0 to 125	Specifies the number of data points to be read from or written to the target device.
Swap Code	None Word swap Word and Byte swap Byte swap	Specifies if the data from the server is to be ordered differently than it was received. This parameter is typically used when dealing with floating-point or other multi-register values. NONE - No change is made (abcd) WORD SWAP - The words are swapped (cdab) WORD AND BYTE SWAP - The words and bytes are swapped (dcba) BYTE SWAP - The bytes are swapped (badc)
IP Address	xxx.xxx.xxx.xxx	Specifies the IP address of the target device to be addressed.
Slot	-1	Specifies the slot number for the device. Use a value of -1 when interfacing to an SLC 5/05. These devices do not have a slot parameter. When addressing a processor in a ControlLogix or CompactLogix rack, the slot number corresponds to the slot in the rack containing the controller being addressed.
Func Code	501 509	Specifies the function code to be used in the command. 501 - Protected Typed Read 509 - Protected Typed Write
File Type	Binary Counter Timer Control Integer Float ASCII String Status	Specifies the file type to be associated with the command.
File Number	-1	Specifies the PLC-5 file number to be associated with the command. If a value of -1 is entered for the parameter, the field will not be used in the command, and the default file will be used.
Element Number		Specifies the element in the file where the command will start.
Comment		Optional 32 character comment for the command.

Class 3 Client[x]/UClient Commands SLC500 3 Address Fields

This command is typically used when accessing data in a Timer or Counter. I.e. T.1.1.2 is the address of the accumulator in Timer 1.

Parameter	Value	Description
Enable	Enable Disable Conditional Write	Specifies if the command should be executed and under what conditions. ENABLE - The Command is executed each scan of the command list DISABLE - The command is disabled and will not be executed CONDITIONAL WRITE - The Command executes only if the internal data associated with the command changes
Internal Address	0 to 3999	Specifies the database address in the modules internal database to be associated with the command. If the command is a read function, the data received in the response message is placed at the specified location. If the command is a write function data used in the command is sourced from specified data area.
Poll Interval	0 to 65535	Specifies the minimum interval to execute continuous commands. The parameter is entered in 1/10 of a second. If a value of 100 is entered for a command, the command executes no more frequently than every 10 seconds.
Reg Count	0 to 125	Specifies the number of data points to be read from or written to the target device.
Swap Code	None Word swap Word and Byte swap Byte swap	Specifies if the data from the server is to be ordered differently than it was received. This parameter is typically used when dealing with floating-point or other multi-register values. NONE - No change is made (abcd) WORD SWAP - The words are swapped (cdab) WORD AND BYTE SWAP - The words and bytes are swapped (dcba) Byte swap - The bytes are swapped (badc)
IP Address	xxx.xxx.xxx.xxx	Specifies the IP address of the target device to be addressed by this command.
Slot	-1	Specifies the slot number for the device. Use a value of -1 when interfacing to an SLC 5/05. These devices do not have a slot parameter. When addressing a processor in a ControlLogix or CompactLogix, the slot number corresponds to the slot in the rack containing the controller being addressed.
Func Code	502 510 511	Specifies the function code to be used in the command. 502 - Protected Typed Read 510 - Protected Typed Write 511 - Protected Typed Write w/Mask

Parameter	Value	Description
File Type	Binary Counter Timer Control Integer Float ASCII String Status	Specifies the file type to be associated with the command.
File Number	-1	Specifies the SLC 500 file number to be associated with the command. If a value of -1 is entered for the parameter, the field will not be used in the command, and the default file will be used.
Element Number		Specifies the element in the file where the command will start.
Sub Element		Specifies the sub-element to be used with the command. Refer to the AB documentation for a list of valid sub-element codes.
Comment		Optional 32 character comment for the command.

Class 3 Client[x]/UClient Commands PLC5 Binary

Parameter	Value	Description
Enable	Enable Disable Conditional Write	Specifies if the command should be executed and under what conditions. ENABLE - The Command is executed each scan of the command list DISABLE - The command is disabled and will not be executed CONDITIONAL WRITE - The Command executes only if the internal data associated with the command changes
Internal Address	0 to 3999	Specifies the database address in the modules internal database to be associated with the command. If the command is a read function, the data received in the response message is placed at the specified location. If the command is a write function data used in the command is sourced from specified data area.
Poll Interval	0 to 65535	Specifies the minimum interval to execute continuous commands. The parameter is entered in 1/10 of a second. If a value of 100 is entered for a command, the command executes no more frequently than every 10 seconds.
Reg Count	0 to 125	Specifies the number of data points to be read from or written to the target device.
Swap Code	None Word swap Word and Byte swap Byte swap	Specifies if the data from the server is to be ordered differently than it was received. This parameter is typically used when dealing with floating-point or other multi-register values. NONE - No change is made (abcd) WORD SWAP - The words are swapped (cdab) WORD AND BYTE SWAP - The words and bytes are swapped (dcba) BYTE SWAP - The bytes are swapped (badc)
IP Address	xxx.xxx.xxx.xxx	Specifies the IP address of the target device to be addressed by this command.
Slot	-1	Specifies the slot number for the device. Use a value of -1 when

Parameter	Value	Description
		interfacing to a PLC5 These devices do not have a slot parameter. When addressing a processor in a ControlLogix or CompactLogix, the slot number corresponds to the slot in the rack containing the controller being addressed.
Func Code	100 101 102	Specifies the function code to be used in the command. 100 - Word Range Write 101 - Word Range Read 102 - Read-Modify-Write
File Number	-1	Specifies the PLC5 file number to be associated with the command. If a value of -1 is entered for the parameter, the field will not be used in the command, and the default file will be used.
Element Number		Specifies the element in the file where the command will start.
Sub Element		Specifies the sub-element to be used with the command. Refer to the AB documentation for a list of valid sub-element codes.
Comment		Optional 32 character comment for the command.

Class 3 Client[x]/UClient Commands PLC5 ASCII

Parameter	Value	Description
Enable	Enable Disable Conditional Write	Specifies if the command should be executed and under what conditions. ENABLE - The Command is executed each scan of the command list DISABLE - The command is disabled and will not be executed CONDITIONAL WRITE - The Command executes only if the internal data associated with the command changes
Internal Address	0 to 3999	Specifies the database address in the modules internal database to be associated with the command. If the command is a read function, the data received in the response message is placed at the specified location. If the command is a write function data used in the command is sourced from specified data area.
Poll Interval	0 to 65535	Specifies the minimum interval to execute continuous commands. The parameter is entered in 1/10 of a second. If a value of 100 is entered for a command, the command executes no more frequently than every 10 seconds.
Reg Count	0 to 125	Specifies the number of data points to be read from or written to the target device.
Swap Code	None Word swap Word and Byte swap Byte swap	Specifies if the data from the server is to be ordered differently than it was received. This parameter is typically used when dealing with floating-point or other multi-register values. NONE - No change is made (abcd) WORD SWAP - The words are swapped (cdab) WORD AND BYTE SWAP - The words and bytes are swapped (dcba) BYTE SWAP - The bytes are swapped (badc)
IP Address	xxx.xxx.xxx.xxx	Specifies IP address of the target device to be addressed by this command.
Slot	-1	Specifies the slot number for the device. Use a value of -1 when

Parameter	Value	Description
		interfacing to a PLC5 These devices do not have a slot parameter. When addressing a processor in a ControlLogix or CompactLogix, the slot number corresponds to the slot in the rack containing the controller being addressed.
Func Code	150 151 152	Specifies the function code to be used in the command. 150 - Word Range Write 151 - Word Range Read 152 - Read-Modify-Write
File String		Specifies the PLC-5 Address as a string. For example N10:300
Comment		Optional 32 character comment for the command.

Class 3 Client[x]/UClient Commands Controller Tag Access

Parameter	Value	Description
Enable	Enable Disable Conditional Write	Specifies if the command should be executed and under what conditions. ENABLE - The Command is executed each scan of the command list DISABLE - The command is disabled and will not be executed CONDITIONAL WRITE - The Command executes only if the internal data associated with the command changes
Internal Address	0 to 3999	Specifies the database address in the modules internal database to be associated with the command. If the command is a read function, the data received in the response message is placed at the specified location. If the command is a write function data used in the command is sourced from specified data area.
Poll Interval	0 to 65535	Specifies the minimum interval to execute continuous commands. The parameter is entered in 1/10 of a second. If a value of 100 is entered for a command, the command executes no more frequently than every 10 seconds.
Reg Count	0 to 125	Specifies the number of data points to be read from or written to the target device.
Swap Code	None Word swap Word and Byte swap Byte swap	Specifies if the data from the server is to be ordered differently than it was received. This parameter is typically used when dealing with floating-point or other multi-register values. NONE - No change is made (abcd) WORD SWAP - The words are swapped (cdab) WORD AND BYTE SWAP - The words and bytes are swapped (dcba) BYTE SWAP - The bytes are swapped (badc)
IP Address	xxx.xxx.xxx.xxx	Specifies the IP address of the target device to be addressed by this command.
Slot	-1	Specifies the slot number for the device. Use a value of -1 when interfacing to a PLC5 These devices do not have a slot parameter. When addressing a processor in a ControlLogix or CompactLogix, the slot number corresponds to the slot in the rack containing the controller being addressed.
Func Code	332 333	Specifies the function code to be used in the command. 332 - CIP Data Table Read 333 - CIP Data Table Write

Data Type	Bool SINT INT DINT REAL DWORD	Specifies the data type of the target controller tag name.
Tag Name		Specifies the controller tag in the target PLC.
Offset	0 to 3999	Specifies the offset database where the value corresponds to the Tag Name parameter
Comment		Optional 32 character comment for the command.

Class 3 Client[x]/UClient Commands CIP Generic

Parameter	Value	Description
Enable	Disabled Enabled Conditional Write	Specifies the condition to execute the command. DISABLED - The command is disabled and will not be executed. ENABLED - The command is executed on each scan of the command list if the <i>Poll Interval</i> is set to zero. If the <i>Poll Interval</i> is non-zero, the command is executed when the interval timer expires. CONDITIONAL WRITE - The command executes only if the internal data value(s) to be sent has changed.
Internal Address	0 to 9998	Specifies the database address in the modules internal database to be associated with the command. If the command is a read function, the data received in the response message is placed at the specified location. If the command is a write function, data used in the command is sourced from specified data area.
Poll Interval	0 to 65535	Specifies the minimum interval to execute continuous commands. The parameter is entered in 1/10 of a second. For example, if a value of '100' is entered for a command, the command executes no more frequently than every 10 seconds.
Reg Count	0 to 125	Specifies the number of data points to read/write to the target device.
Swap Code	None Word swap Word and Byte swap Byte swap	Specifies if the data from the server is to be ordered differently than it was received. This parameter is typically used when dealing with floating-point or other multi-register values. NONE - No change is made (abcd) WORD SWAP - The words are swapped (cdab) WORD AND BYTE SWAP - The words and bytes are swapped (dcba) BYTE SWAP - The bytes are swapped (badc)
IP Address	xxx.xxx.xxx.xxx	Specifies the IP address of the target device to be addressed by this command.
Slot	-1	Use '-1' to target a connected device. Use > -1 to target a device in a specific slot number within the rack.
Func Code	CIP Generic	Used to read/write the attributes of any object by using an explicit address
Service Code	00 to FF (Hex)	An integer identification value which denotes a particular Object Instance and/or Object class function. For more information refer to ODVA CIP specification.

Class	00 to FFFF (Hex)	An integer identification value assigned to each Object Class accessible from the network. For more information, refer to ODVA CIP specification.
Instance	Application-dependent	An integer identification value assigned to an Object Instance that identifies it among all Instances of the same Class. For more information, refer to ODVA CIP specification.
Attribute	00 to FFFF (Hex)	An integer identification value assigned to a Class and/or Instance Attribute. For more information, refer to ODVA CIP specification.
Comment		This field can be used to give a 32 character comment to the command. The ":" and "#" characters are reserved characters. It is strongly recommended not be use in the comment section.

Note: Due to the behavior of Connected Clients, please note the following:

- You cannot configure multiple commands with different Class objects to the same device.
- You cannot configure multiple commands with different Class objects to different devices.
- You can configure multiple commands using the Get_Attribute_Single of the same Class and address different Attributes.
- If you have commands in any of the other command types (i.e. Controller Tag Access) and configure a CIP Generic command to the same device, it will not work due to the Connected Client having an active connection to a device. However, you can use both Controller Tag Access and CIP Generic if the target devices are different.
- To avoid any or all these scenarios, it is recommended to use the Unconnected Client if you wish to send commands to different devices, since these connections are reset/closed after each command is executed.

Class 3 Client[x]/UClient Commands Basic

Parameter	Value	Description
Enable	Enable Disable Conditional Write	Specifies if the command should be executed and under what conditions. ENABLE - The command is executed each scan of the command list DISABLE - The command is disabled and will not be executed CONDITIONAL WRITE - The command executes only if the internal data associated with the command changes
Internal Address	0 to 3999	Specifies the database address in the module's internal database to be associated with the command. If the command is a read function, the data received in the response message is placed at the specified location. If the command is a write function data used in the command is sourced from the specified data area.
Poll Interval	0 to 65535	Specifies the minimum interval to execute continuous commands. The parameter is entered in 1/10 of a second. If a value of 100 is entered for a command, the command executes no more frequently than every 10 seconds.
Reg Count	0 to 125	Specifies the number of data points to be read from or written to the target device.
Swap Code	None Word swap Word and Byte swap Byte swap	Specifies if the data from the server is to be ordered differently than it was received. This parameter is typically used when dealing with floating-point or other multi-register values. NONE - No change is made (abcd) WORD SWAP - The words are swapped (cdab) WORD AND BYTE SWAP - The words and bytes are swapped (dcba) BYTE SWAP - The bytes are swapped (badc)
IP Address	xxx.xxx.xxx.xxx	Specifies the IP address of the target device to be addressed by this command.
Slot	-1	Use a value of -1 when interfacing to an SLC 5/05. These devices do not have a slot parameter. When addressing a processor in a ControlLogix or CompactLogix, the slot number corresponds to the slot in the rack containing the controller being addressed.
Func Code	1 2 3 4 5	Specifies the function code to be used in the command. 1 - Protected Write 2 - Unprotected Read 3 - Protected Bit Write 4 - Unprotected Bit Write 5 - Unprotected Write
Word Address		Specifies the word address where to start the operation.
Comment		Optional 32 character comment for the command.

5.3 Network Diagnostics

5.3.1 EIP PCB Diagnostics

The best way to troubleshoot the EIP driver is to use ProSoft Configuration Builder to access the diagnostic capabilities of the gateway through the Ethernet debug port.

The following table summarizes the status information available in PCB for the EIP driver:

Connection Type	Submenu Item	Description
EIP Class 1	Config	Configuration settings for Class 1 Connections.
	Status	Status of the Class 1 Connections. Displays any configuration error, as well as the number of Class 1 Connections.
EIP Class 3 Server	Config	Configuration settings for Class 3 Server Connections.
	Comm Status	Status information for each Class 3 Server Connection. Displays port numbers, IP addresses, socket status, and read and write counts.
EIP Class 3 Client/UClient [x]	Config	Configuration settings for Class 3 Client/UClient Connections.
	Comm Status	Status information for Class 3 Client/UClient [x] commands. Displays a summary of all the errors resulting from Class 3 Client/UClient [x] commands.
	Commands	Configuration for the Class 3 Client/UClient [x] command list.
	Cmd Errors (Decimal)	Current error codes for each command on the Class 3 Client/UClient [x] command list in decimal number format. A zero means there is currently no error for the command.
	Cmd Errors (Hex)	Current error codes for each command on the Class 3 Client/UClient [x] command list in hexadecimal number format. A zero means there is currently no error for the command.

For specific information on error codes, see EIP Error Codes (page 69).

5.3.2 EIP Status Data in Upper Memory

The EIP driver has an associated status data area located in the PLX3x gateway's upper memory. The *Data Map* functionality of the PLX3x gateway can be used to map this data into the normal user data range of the PLX3x gateway's database.

Note that all the status values are initialized to zero (0) at power-up, cold boot and during warm boot.

EIP Client Status Data

The following table lists the addresses in upper memory the PLX3x gateway stores general error and status data for each EIP connected and unconnected client:

EIP Client	Address Range
Connected Client 0	12000 through 12109
Connected Client 1	12400 through 12509
Unconnected Client 0	12600 through 12709

The content of each client's status data area is structured in the same way. The following table describes the content of each register in the status data area:

Offset	Description
0	Number of Command Requests
1	Number of Command Responses
2	Number of Command Errors
3	Number of Requests
4	Number of Responses
5	Number of Errors Sent
6	Number of Errors Received
7	Reserved
8	Current Error Code
9	Last Error Code

EIP Client Command List Error Data

The PLX3x gateway stores a status/error code in upper memory for each command in each EIP client's command list. The following table lists the addresses in upper memory where the gateway stores the command list error data for each EIP client:

EIP Client	Address Range
Connected client 0	7910 through 8009
Connected client 1	8110 through 8209
Unconnected client 0	12810 through 12909

The first word in each client's command list error data area contains the status/error code for the first command in the client's command list. Each successive word in the command error list is associated with the next command in the list. Therefore, the size of the command list error data area depends on the number of commands defined.

The structure of the command list error data area (which is the same for all clients) is displayed in the following table:

Offset	Description
0	Command #1 Error Code
1	Command #2 Error Code
2	Command #3 Error Code
3	Command #4 Error Code
4	Command #5 Error Code
.	.
.	.
.	.
97	Command #98 Error Code
98	Command #99 Error Code
99	Command #100 Error Code

EIP Server Status Data

The following table lists the addresses in upper memory where the PLX3x gateway stores status data for each EIP server:

EIP Server	Address Range
0	11000 through 11015
1	11016 through 11031
2	11032 through 11047
3	11048 through 11063
4	11064 through 11079

The content of each server's status data area is structured the same. The following table describes the content of each register in the status data area:

Offset	Description
0 through 1	Connection State
2 through 3	Open Connection Count
4 through 5	Socket Read Count
6 through 7	Socket Write Count
8 through 15	Peer IP

5.3.3 EIP Error Codes

The gateway stores error codes returned from the command list process in the command list error memory region. A word is allocated for each command in the memory area. The error codes are formatted in the word as follows: The least-significant byte of the word contains the extended status code and the most-significant byte contains the status code.

Use the error codes returned for each command in the list to determine the success or failure of the command. If the command fails, use the error code to determine the cause of failure.

Warning: The gateway specific error codes (not EtherNet/IP/PCCC compliant) are returned from within the gateway and never returned from an attached EtherNet/IP/PCCC slave device. These are error codes that are part of the EtherNet/IP/PCCC protocol or are extended codes unique to the PLX3x gateway. The common errors for the EtherNet/IP/PCCC protocol are shown below.

Local STS Error Codes

Code (Int)	Code (Hex)	Description
0	0x0000	Success, no error
256	0x0100	DST node is out of buffer space
512	0x0200	Cannot guarantee delivery (Link Layer)
768	0x0300	Duplicate token holder detected
1024	0x0400	Local port is disconnected
1280	0x0500	Application layer timed out waiting for response
1536	0x0600	Duplicate node detected
1792	0x0700	Station is offline
2048	0x0800	Hardware fault

Remote STS Error Codes

Code (Int)	Code (Hex)	Description
0	0x0000	Success, no error
4096	0x1000	Illegal command or format
8192	0x2000	Host has a problem and will not communicate
12288	0x3000	Remote node host is missing, disconnected or shut down
16384	0x4000	Host could not complete function due to hardware fault
20480	0x5000	Addressing problem or memory protect rungs
24576	0x6000	Function not allowed due to command protection selection
26872	0x7000	Processor is in Program mode
-32768	0x8000	Compatibility mode file missing or communication zone problem
-28672	0x9000	Remote node cannot buffer command
-24576	0xA000	Wait ACK (1775-KA buffer full)
-20480	0xB000	Remote node problem due to download

Code (Int)	Code (Hex)	Description
-16384	0xC000	Wait ACK (1775-KA buffer full)
-12288	0xD000	Not used
-8192	0xE000	Not used
	0xF0nn	Error code in the EXT STS byte (nn contains EXT error code)

EXT STS Error Codes

Code (Int)	Code (Hex)	Description
-4096	0xF000	Not used
-4095	0xF001	A field has an illegal value
-4094	0xF002	Fewer levels specified in address than minimum for any address
-4093	0xF003	More levels specified in address than system supports
-4092	0xF004	Symbol not found
-4091	0xF005	Symbol is of improper format
-4090	0xF006	Address does not point to something usable
-4089	0xF007	File is wrong size
-4088	0xF008	Cannot complete request
-4087	0xF009	Data or file is too large
-4086	0xF00A	Transaction size plus word address is too large
-4085	0xF00B	Access denied, improper privilege
-4084	0xF00C	Condition cannot be generated - resource is not available
-4083	0xF00D	Condition already exists - resource is already available
-4082	0xF00E	Command cannot be executed
-4081	0xF00F	Histogram overflow
-4080	0xF010	No access
-4079	0xF011	Illegal data type
-4078	0xF012	Invalid parameter or invalid data
-4077	0xF013	Address reference exists to deleted area
-4076	0xF014	Command execution failure for unknown reason
-4075	0xF015	Data conversion error
-4074	0xF016	Scanner not able to communicate with 1771 rack adapter
-4073	0xF017	Type mismatch
-4072	0xF018	1171 Gateway response was not valid
-4071	0xF019	Duplicate label
-4070	0xF01A	File is open; another node owns it
-4069	0xF01B	Another node is the program owner
-4068	0xF01C	Reserved
-4067	0xF01D	Reserved
-4066	0xF01E	Data table element protection violation
-4065	0xF01F	Temporary internal problem

EIP Error Codes

Code (Int)	Code (Hex)	Description
-1	0xFFFF	CTS modem control line not set before transmit
-2	0xFFFE	Timeout while transmitting message
-10	0xFFFF6	Timeout waiting for DLE-ACK after request
-11	0xFFFF5	Timeout waiting for response after request
-12	0xFFFF4	Reply data does not match requested byte count
-20	0xFFEC	DLE-NAK received after request
-21	0xFFEB	DLE-NAK sent after response
-200	0xFF38	DLE-NAK received after request

TCP/IP Interface Error Codes

Error (Int)	Error (Hex)	Description
-33	0xFFDF	Failed to connect to target
-34	0xFFDE	Failed to register session with target (timeout)
-35	0xFFDD	Failed forward open response timeout
-36	0xFFDC	PCCC/Tag command response timeout
-37	0xFFDB	No TCP/IP connection error

Common Response Error Codes

Error (Int)	Error (Hex)	Description
-40	0xFFD8	Invalid response length
-41	0xFFD7	CPF item count not correct
-42	0xFFD6	CPF address field error
-43	0xFFD5	CPF packet tag invalid
-44	0xFFD4	CPF bad command code
-45	0xFFD3	CPF status error reported
-46	0xFFD2	CPF incorrect connection ID value returned
-47	0xFFD1	Context field not matched
-48	0xFFD0	Incorrect session handle returned
-49	0xFFCF	CPF not correct message number

Register Session Response Error Codes

Error (Int)	Error (Hex)	Description
-50	0xFFCE	Message length received not valid
-51	0xFFCD	Status error reported
-52	0xFFCC	Invalid version

Forward Open Response Error Codes

Error (Int)	Error (Hex)	Description
-55	0xFFC9	Message length received not valid
-56	0xFFC8	Status error reported

PCCC Response Error Codes

Error (Int)	Error (Hex)	Description
-61	0xFFC3	Message length received not valid
-62	0xFFC2	Status error reported
-63	0xFFC1	CPF bad command code
-64	0xFFC0	TNS in PCCC message not matched
-65	0xFFBF	Vendor ID in PCCC message not matched
-66	0xFFBE	Serial number in PCCC message not matched

5.4 EIP Reference

5.4.1 SLC and MicroLogix Specifics

Messaging from a SLC 5/05

The PLX3x gateway can receive messages from a SLC 5/05 containing an Ethernet interface. The gateway supports both read and write commands.

SLC5/05 Write Commands

Write commands transfer data from the SLC processor to the gateway. The following diagram shows an example rung to execute a write command.

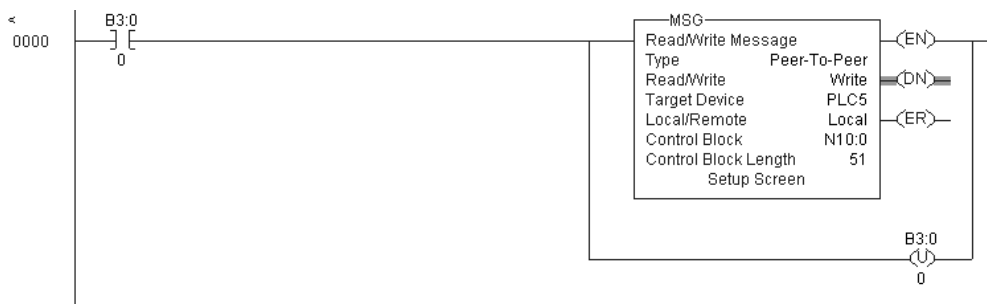

- 1 Set the **READ/WRITE** parameter to **WRITE**. The gateway supports a **TARGET DEVICE** parameter value of **500CPU** or **PLC5**.

- In the MSG object, click **SETUP SCREEN** in the MSG object to complete the configuration of the MSG instruction. This displays the following dialog box.

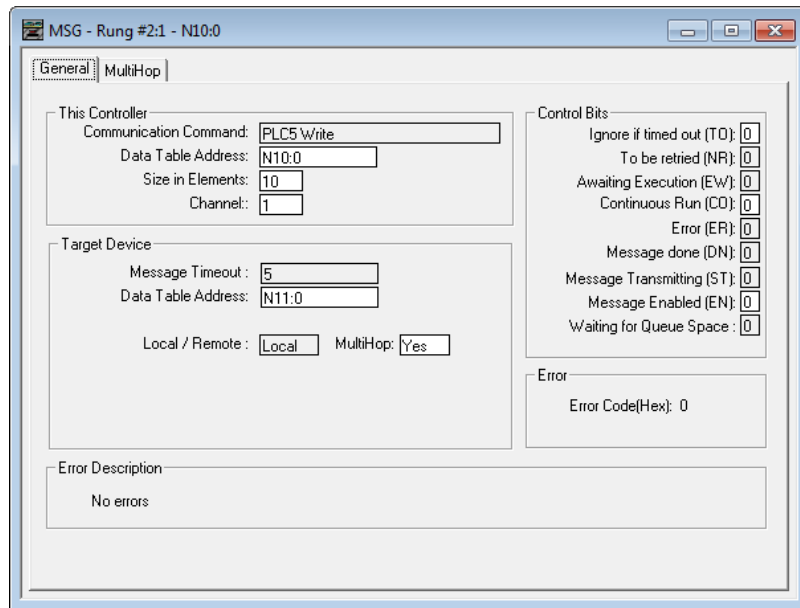

- Set the **TARGET DEVICE DATA TABLE ADDRESS** to a valid file element (such as, N11:0) for SLC and PLC5 messages.
- Set the **MULTIHOP** option to **YES**.
- Complete the **MULTIHOP** tab portion of the dialog box shown in the following image.

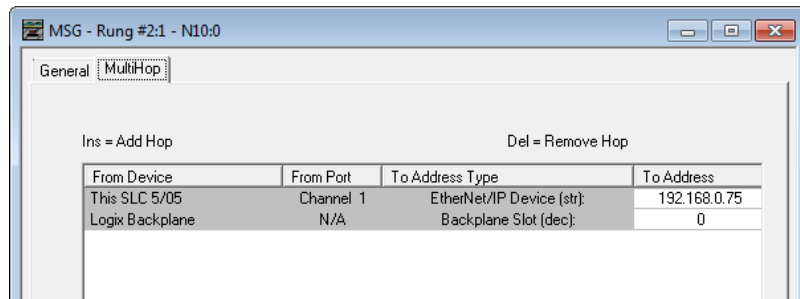

- Set the **TO ADDRESS** value to the gateway's Ethernet IP address.
- Press the **INS** key to add the second line for ControlLogix Backplane and set the slot number to zero.

SLC5/05 Read Commands

Read commands transfer data to the SLC processor from the gateway. The following diagram shows an example rung to execute a read command.

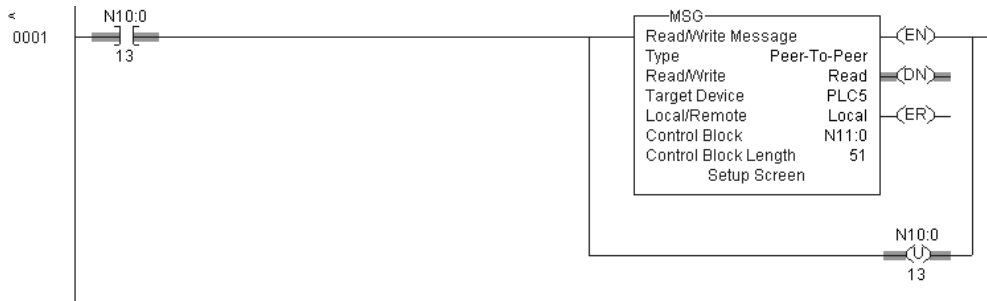

- 1 Set the **READ/WRITE** parameter to **READ**. The gateway supports a **TARGET DEVICE** parameter value of **500CPU** or **PLC5**.
- 2 In the MSG object, click **SETUP SCREEN** in the MSG object to complete the configuration of the MSG instruction. This displays the following dialog box.

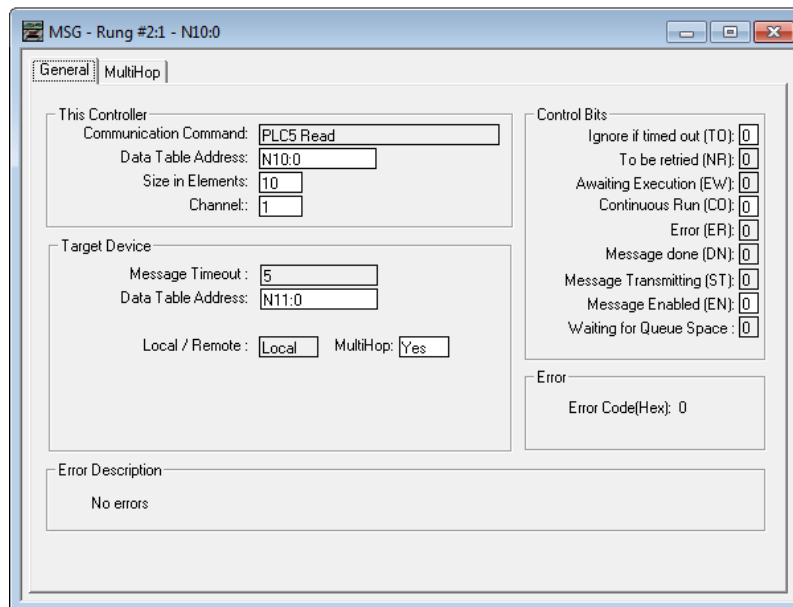

- 3 Set the **TARGET DEVICE DATA TABLE ADDRESS** to a valid file element (such as, N11:0) for SLC and PLC5 messages.
- 4 Set the **MULTIHOP** option to **YES**.

- Fill in the **MULTIHOP** tab portion of the dialog box as shown in the following image.

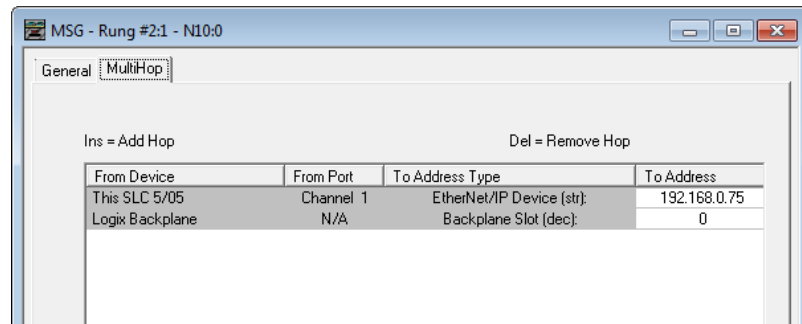

- Set the **TO ADDRESS** value to the gateway's Ethernet IP address.
- Press the **INS** key to add the second line for ControlLogix Backplane and set the slot number to zero.

SLC File Types

This information is specific to the SLC and MicroLogix family or processors used with the PCCC command set. The SLC and MicroLogix processor commands support a file type field entered as a single character to denote the data table to use in the command. The following table defines the relationship of the file types accepted by the gateway and the SLC file types.

File Type	Description
S	Status
B	Bit
T	Timer
C	Counter
R	Control
N	Integer
F	Floating-point
Z	String
A	ASCII

The *File Type Command Code* is the ASCII character code value of the File Type letter. This is the value to enter for the **FILE TYPE** parameter of the PCCC Command configurations in the data tables in the ladder logic.

Additionally, the SLC specific functions (502, 510 and 511) support a sub-element field. This field selects a sub-element field in a complex data table. For example, to obtain the current accumulated value for a counter or timer, set the sub-element field to 2.

5.4.2 PLC5 Processor Specifics

Messaging from a PLC5

The gateway can receive messages from a PLC5 containing an Ethernet interface. The gateway supports both read and write commands.

PLC5 Write Commands

Write commands transfer data from the PLC5 processor to the gateway. The following diagram shows an example rung to execute a write command.

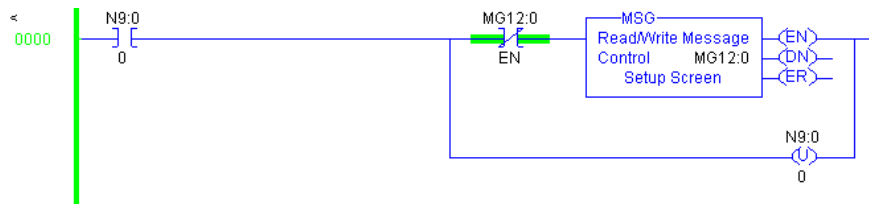

- 1 In the MSG object, click **SETUP SCREEN** in the MSG object to complete the configuration of the MSG instruction. This displays the following dialog box.

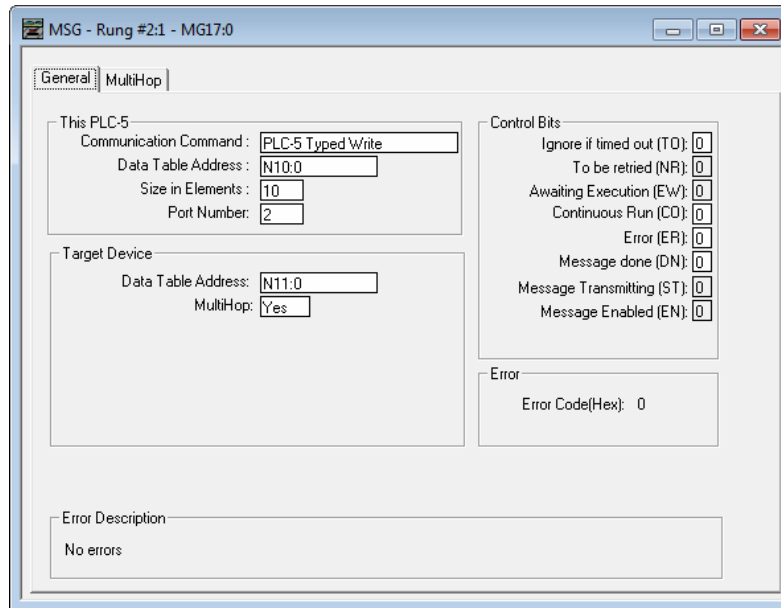

- 2 Select the **COMMUNICATION COMMAND** to execute from the following list of supported commands.
 - PLC5 Type Write
 - PLC2 Unprotected Write
 - PLC5 Typed Write to PLC
 - PLC Typed Logical Write

- 3 Set the **TARGET DEVICE DATA TABLE ADDRESS** to a valid file element (such as, N11:0) for SLC and PLC5 messages. For the PLC2 Unprotected Write message, set the address to the database index (such as, 1000) for the command.
- 4 Set the **MULTIHOP** option to **YES**.
- 5 Complete **MULTIHOP** tab portion of the dialog box as shown in the following image.

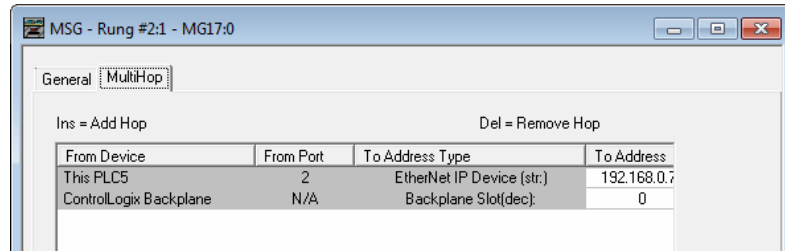

- 6 Set the **TO ADDRESS** value to the gateway's Ethernet IP address.
- 7 Press the **INS** key to add the second line for ControlLogix Backplane and set the slot number to zero.

PLC5 Read Commands

Read commands transfer data to the PLC5 processor from the gateway. The following diagram shows an example rung that executes a read command.

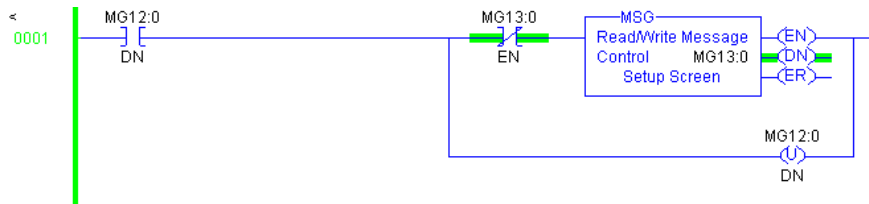

- 1 In the MSG object, click **SETUP SCREEN** in the MSG object to complete the configuration of the MSG instruction. This displays the following dialog box.

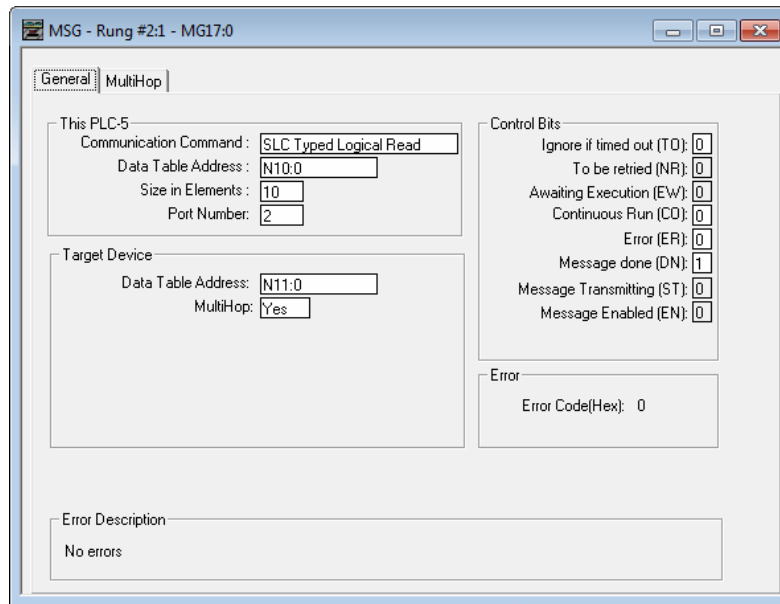

- 2 Select the **COMMUNICATION COMMAND** to execute from the following list of supported commands.
 - PLC5 Type Read
 - PLC2 Unprotected Read
 - PLC5 Typed Read to PLC
 - PLC Typed Logical Read
- 3 Set the **TARGET DEVICE DATA TABLE ADDRESS** to a valid file element (such as, N11:0) for SLC and PLC5 messages. For the PLC2 Unprotected Read message, set the address to the database index (such as, 1000) for the command.
- 4 Set the **MULTIHOP** option to **YES**.
- 5 Complete the **MULTIHOP** tab portion of the dialog box as shown in the following image.

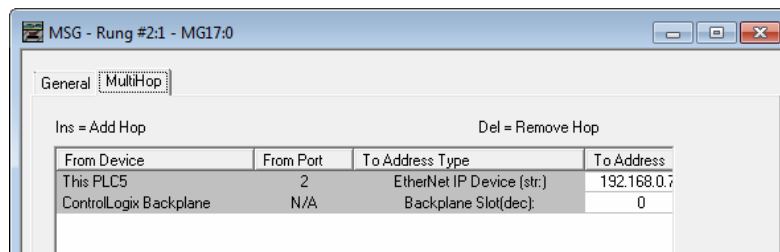

- 6 Set the **TO ADDRESS** value to the gateway's Ethernet IP address.
- 7 Press the **INS** key to add the second line for ControlLogix Backplane and set the slot number to zero.

PLC-5 Sub-Element Fields

This section contains information specific to the PLC-5 processor when using the PCCC command set. The commands specific to the PLC-5 processor contain a sub-element code field. This field selects a sub-element field in a complex data table. For example, to obtain the current accumulated value for a counter or timer, set the sub-element field to 2. The following tables show the sub-element codes for PLC-5 complex data tables.

Timer / Counter

Code	Description
0	Control
1	Preset
2	Accumulated

Control

Code	Description
0	Control
1	Length
2	Position

PD

All PD values are floating point values, they are two words long.

Code	Description
0	Control
2	SP
4	Kp
6	Ki
8	Kd
26	PV

BT

Code	Description
0	Control
1	RLEN
2	DLEN
3	Data file #
4	Element #
5	Rack/Grp/Slot

MG

Code	Description
0	Control
1	Error
2	RLEN
3	DLEN

5.4.3 ControlLogix and CompactLogix Processor Specifics

Messaging from a ControlLogix or CompactLogix Processor

Use the MSG instruction to exchange data between a Control/CompactLogix processor and the gateway. There are two basic methods of data transfer supported by the gateway when using the MSG instruction: encapsulated PCCC messages and CIP Data Table messages. You can use either method.

Encapsulated PCCC Messages

This section contains information specific to the Control/CompactLogix processor when using the PCCC command set. The current implementation of the PCCC command set does not use functions that can directly access the Controller Tag Database. In order to access this database, you must use the table-mapping feature in RSLogix 5000. RSLogix 5000 permits assigning Controller Tag Arrays to virtual PLC 5 data tables. The PLX3x gateway using the PLC 5 command set defined in this document can then access this controller data.

PLC5 and SLC5/05 processors containing an Ethernet interface use the encapsulated PCCC message method. The gateway simulates these devices and accepts both read and write commands.

Encapsulated PCCC Write Message

Write commands transfer data from the processor to the gateway. The gateway supports the following encapsulated PCCC commands:

- PLC2 Unprotected Write
- PLC5 Typed Write
- PLC5 Word Range Write
- PLC Typed Write

The following diagram shows an example rung that executes a write command.

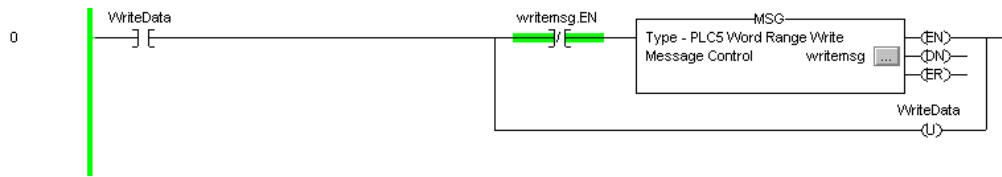

- 1 In the *Message Configuration* dialog box, define the data set to be transferred from the processor to the gateway as shown in the following image.

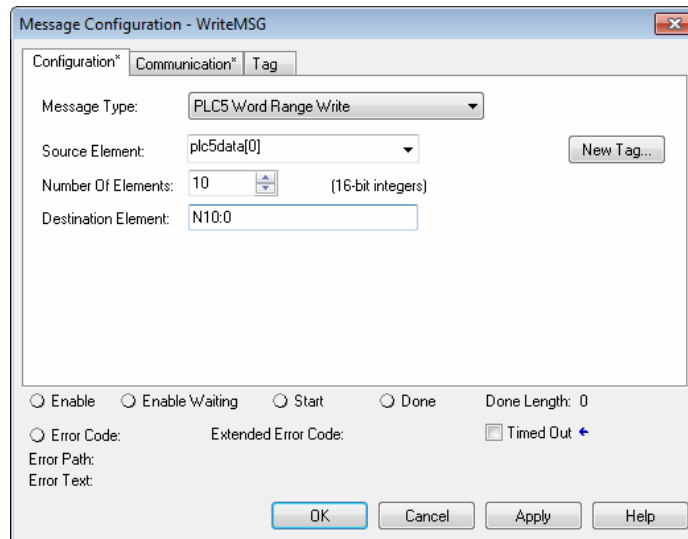

- 2 Complete the dialog box for the data area to be transferred.
 - For PLC5 and SLC messages, set the **DESTINATION ELEMENT** to an element in a data file (such as, N10:0).
 - For the PLC2 Unprotected Write message, set the **DESTINATION ELEMENT** to the address in the gateway's internal database. This cannot be set to a value less than ten. This is not a limitation of the gateway but of the RSLogix software.
 - For a PLC2 Unprotected Write or Read function, enter the database address in octal format.

- 3 Click the **COMMUNICATION** tab and complete the communication information as shown in the following image.

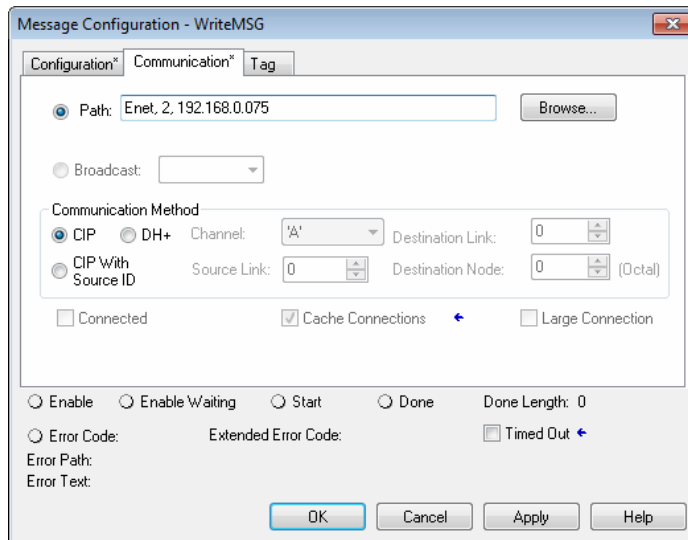

- 4 Make sure you select **CIP** as the **COMMUNICATION METHOD**. The **PATH** specifies the message route from the processor to the EIP gateway. Path elements are separated by commas. In the example path shown:
 - The first element is "Enet", which is the user-defined name given to the 1756-ENET gateway in the chassis (you can substitute the slot number of the ENET gateway for the name)
 - The second element, "2", represents the Ethernet port on the 1756-ENET gateway.
 - The last element of the path, "192.168.0.75" is the IP address of the gateway, which is the target for the message.

More complex paths are possible if routing to other networks using multiple 1756-ENET gateways and racks. Refer to the ProSoft Technology Technical Support Knowledgebase for more information on Ethernet routing and path definitions (www.prosoft-technology.com/support).

Encapsulated PCCC Read Message

Read commands transfer data from the gateway to a processor. The gateway supports the encapsulated PCCC commands:

- PLC2 Unprotected Read
- PLC5 Typed Read
- PLC5 Word Range Read
- PLC Typed Read

The following diagram shows an example rung that executes a read command.

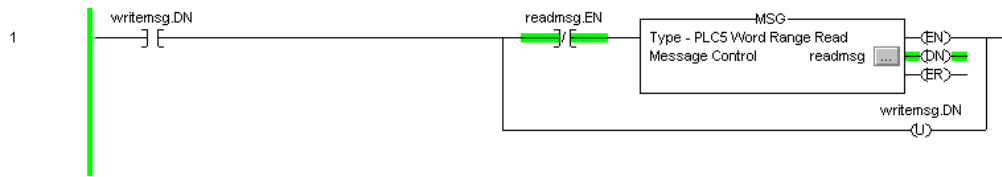

- 1 In the *Message Configuration* dialog box, define the data set to be transferred from the processor to the gateway as shown in the following image.

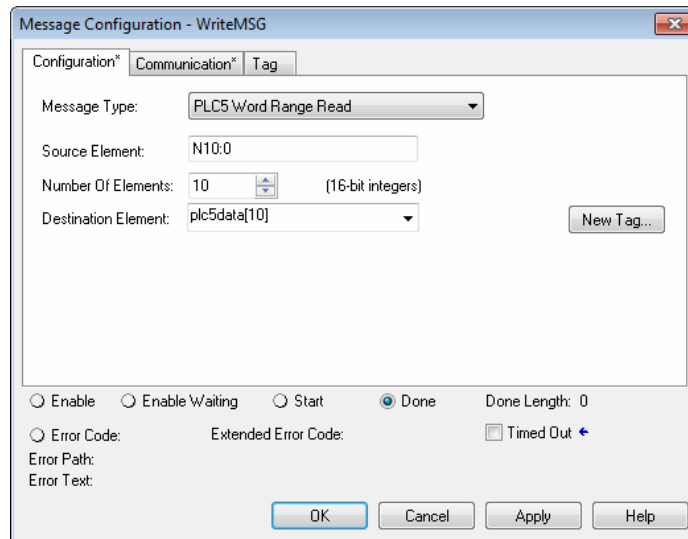

- 2 Complete the dialog box for the data area to be transferred.
 - For PLC5 and SLC messages, set the **SOURCE ELEMENT** to an element in a data file (such as, N10:0).
 - For the PLC2 Unprotected Read message, set the **SOURCE ELEMENT** to the address in the gateway's internal database. This cannot be set to a value less than ten. This is not a limitation of the gateway but of the RSLogix software.

- 3 Click the **COMMUNICATION** tab and complete the communication information as shown in the following image.

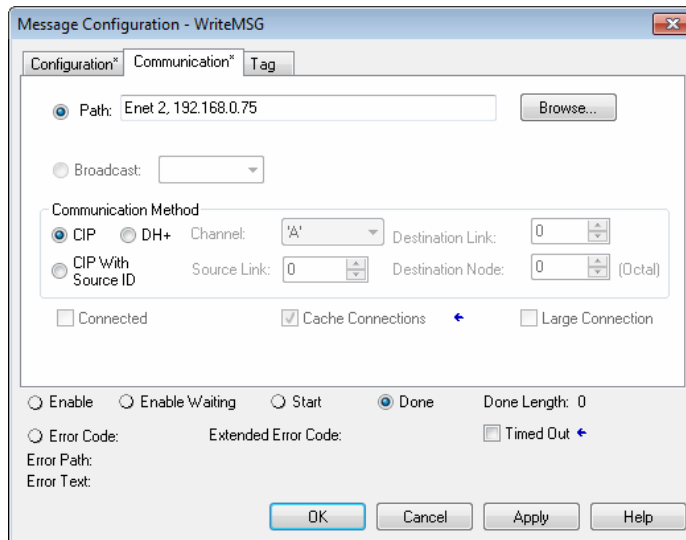

- 4 Make sure you select **CIP** as the **COMMUNICATION METHOD**. The **PATH** specifies the message route from the processor to the EIP gateway. Path elements are separated by commas. In the example path shown:
 - The first element is "Enet", which is the user-defined name given to the 1756-ENET gateway in the chassis (you can substitute the slot number of the ENET gateway for the name)
 - The second element, "2", represents the Ethernet port on the 1756-ENET gateway.
 - The last element of the path, "192.168.0.75" is the IP address of the gateway, and the target for the message.

More complex paths are possible if routing to other networks using multiple 1756-ENET gateways and racks. Refer to the ProSoft Technology Technical Support Knowledgebase for more information on Ethernet routing and path definitions (www.prosoft-technology.com/support).

CIP Data Table Operations

You can use CIP messages to transfer data between the ControlLogix or CompactLogix processor and the gateway. Tag names define the elements to be transferred. The gateway supports both read and write operations.

CIP Data Table Write

CIP data table write messages transfer data from the processor to the gateway. The following diagram shows an example rung that executes a write command.

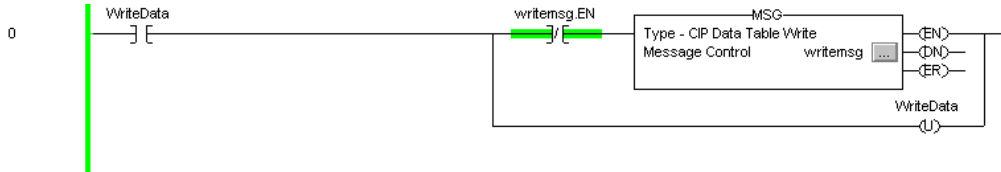

- 1 In the *Message Configuration* dialog box, define the data set to be transferred from the processor to the gateway as shown in the following image.

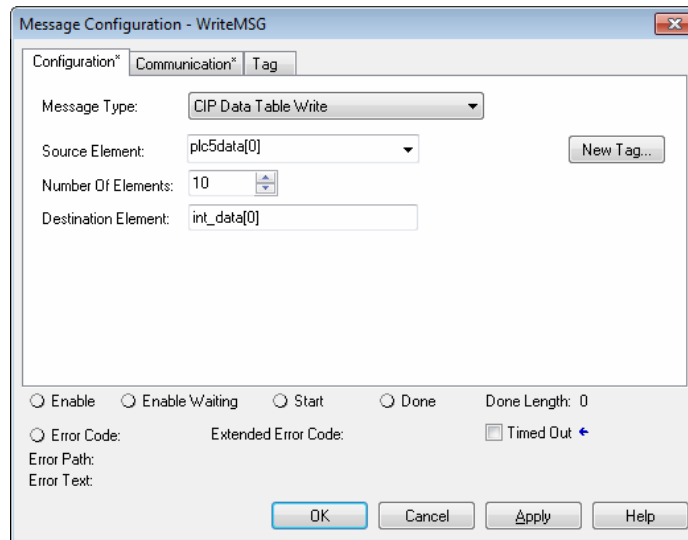

- 2 Complete the dialog box for the data area to be transferred. CIP Data Table messages require a tag database element for both the source and destination.
 - The **SOURCE TAG** is a tag defined in the Controller Tag database.
 - The **DESTINATION ELEMENT** is the tag element in the gateway.
 - The gateway simulates a tag database as an array of elements defined by the maximum register size for the gateway with the tag name **INT_DATA** (with the maximum value of int_data[3999]).

- 3 In the previous example, the first element in the database is the starting location for the write operation of ten elements. Click the **COMMUNICATION** tab and complete the communication information as shown in the following image.

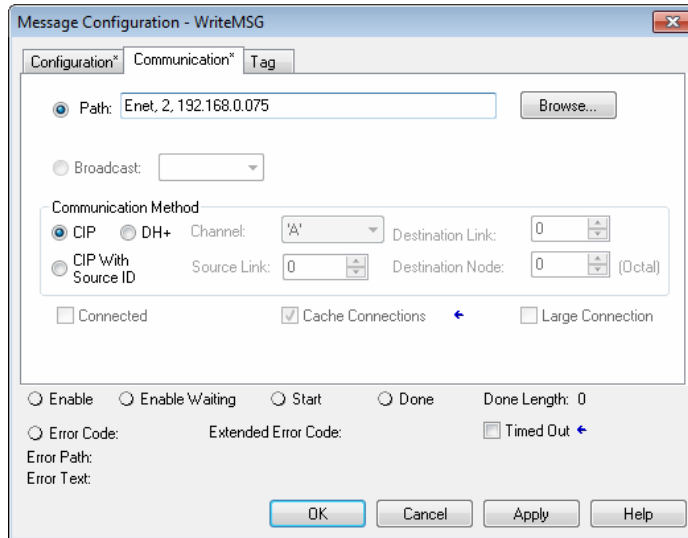

- 4 Make sure you select **CIP** as the **COMMUNICATION METHOD**. The **PATH** specifies the message route from the processor to the EIP gateway. Path elements are separated by commas. In the example path shown:
 - o The first element is "Enet", which is the user-defined name given to the 1756-ENET gateway in the chassis (you can substitute the slot number of the ENET gateway for the name)
 - o The second element, "2", represents the Ethernet port on the 1756-ENET gateway.
 - o The last element of the path, "192.168.0.75" is the IP address of the gateway, which is the target for the message.

More complex paths are possible if routing to other networks using multiple 1756-ENET gateways and racks. Refer to the ProSoft Technology Technical Support Knowledgebase for more information on Ethernet routing and path definitions (www.prosoft-technology.com/support).

CIP Data Table Read

CIP data table read messages transfer data to the processor from the gateway. The following diagram shows an example rung that executes a read command.

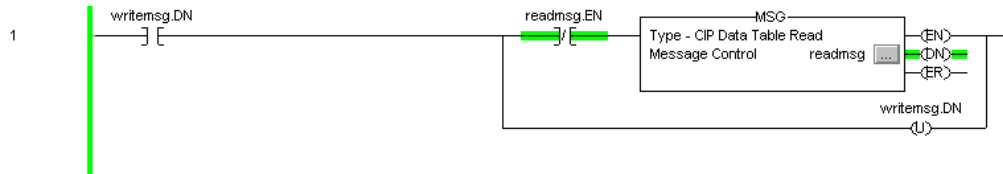

- 1 In the *Message Configuration* dialog box, define the data set to be transferred from the processor to the gateway as shown in the following image.

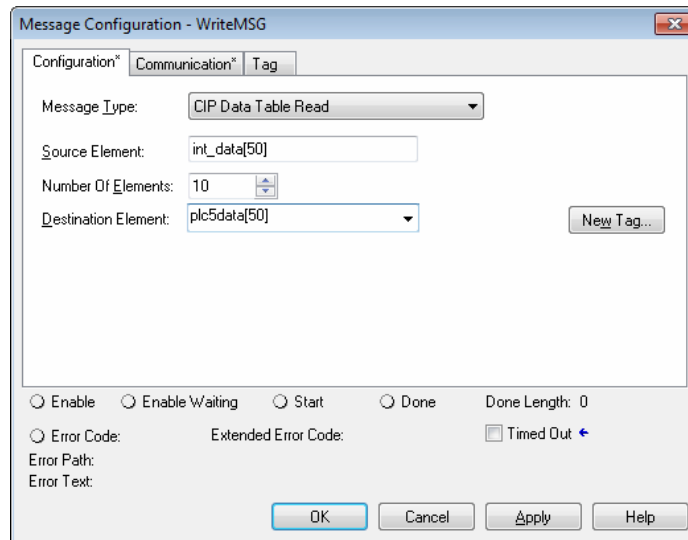

- 2 Complete the dialog box for the data area to be transferred. CIP Data Table messages require a tag database element for both the source and destination.
 - The **DESTINATION TAG** is a tag defined in the Controller Tag database.
 - The **SOURCE ELEMENT** is the tag element in the gateway.
 - The gateway simulates a tag database as an array of elements defined by the maximum register size for the gateway (user configuration parameter "Maximum Register" in the [Gateway] section) with the tag name **INT_DATA**.

- 3 In the previous example, the first element in the database is the starting location for the read operation of ten elements. Click the **COMMUNICATION** tab and complete the communication information as shown in the following image.

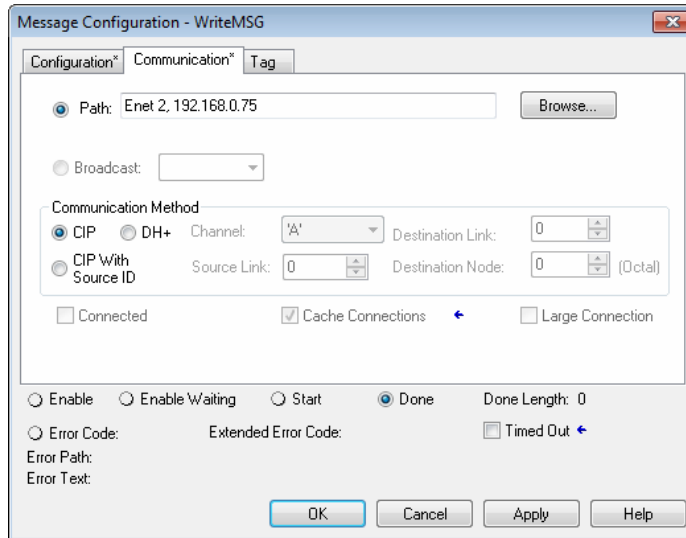

- 4 Make sure you select **CIP** as the **COMMUNICATION METHOD**. The **PATH** specifies the message route from the processor to the EIP gateway. Path elements are separated by commas. In the example path shown:
- The first element is "Enet", which is the user-defined name given to the 1756-ENET gateway in the chassis (you can substitute the slot number of the ENET gateway for the name)
 - The second element, "2", represents the Ethernet port on the 1756-ENET gateway.
 - The last element of the path, "192.168.0.75" is the IP address of the gateway, which is the target for the message.

More complex paths are possible if routing to other networks using multiple 1756-ENET gateways and racks. Refer to the ProSoft Technology Technical Support Knowledgebase for more information on Ethernet routing and path definitions (www.prosoft-technology.com/support).

5.4.4 EIP Command Entry Form

Use the following form to design the application's command list.

Gateway Information Data						Device Information Data						
Column #	1	2	3	4	5	6	7	8	9	10	11	12
Function Code	Enable Code	Internal Address	Poll Interval Time	Count	Swap Code	IP Address	Slot Number	Function Code	Function Parameters			

IP Address = IP address of processor to reach
Slot Number = -1 for PLC5 & SLC, processor slot number of ControlLogix

6 MBTCP Protocol

In This Chapter

- ❖ MBTCP Functional Overview 91
- ❖ MBTCP Configuration 97
- ❖ Network Diagnostics..... 104
- ❖ MBTCP Reference 108

6.1 MBTCP Functional Overview

You can use the PLX3x gateway Modbus TCP/IP (MBTCP) protocol to interface many different protocols into the Schneider Electric Quantum family of processors as well other devices supporting the protocol. The MBTCP protocol supports both client and server connections.

The gateway supports a client connection on the TCP/IP network to interface with processors (and other server based devices) using a command list of up to 100 entries that you specify. The gateway stores the write commands for remote processors in the gateway's lower memory. This is also where the gateway stores data from read commands from other devices. See MBTCP Internal Database (page 93) for more information.

Data in the lower memory of the gateway's internal database is accessible for read and write operations by any node on the network supporting the MBAP (Service Port 502) or MBTCP (Service Ports 2000/2001) TCP/IP protocols. The MBAP protocol (Port 502) is a standard implementation defined by Schneider Electric and used on their Quantum processor. This open protocol is a modified version of the Modbus serial protocol. The MBTCP protocol is an embedded Modbus protocol message in a TCP/IP packet. The gateway supports up to five active server connections on Service Ports 502, five additional active server connections on Service Port 2000, and one active client connection.

The following illustration shows the functionality of the Modbus TCP/IP protocol.

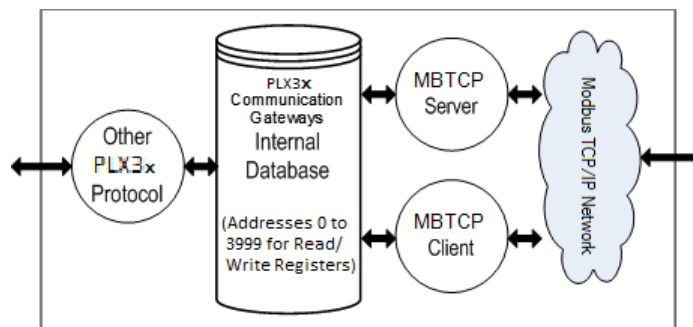

6.1.1 MBTCP General Specifications

The Modbus TCP/IP protocol allows multiple independent, concurrent Ethernet connections. The connections may be all clients, all servers, or a combination of both client and server connections.

- 10/100 MB Ethernet Communication port
- Supports Enron version of Modbus protocol for floating-point data transactions
- Configurable parameters for the client including a minimum response delay of 0 to 65535 ms and floating-point support
- Supports five independent server connections for Service Port 502
- Supports five independent server connections for Service Port 2000
- All data mapping begins at Modbus register 400001, protocol base 0.
- Error codes, network error counters, and port status data available in user data memory

Modbus TCP/IP Client

- Actively reads data from and writes data to Modbus TCP/IP devices using MBAP
- Up to 10 client connections with multiple commands to talk to multiple servers

Modbus TCP/IP Server

- The server driver accepts incoming connections on Service Port 502 for clients using Modbus TCP/IP MBAP messages and connections on Service Port 2000 (or other Service Ports) for clients using Encapsulated Modbus messages.
- Supports multiple independent server connections for any combination of Service Port 502 (MBAP) and Service Port 2000 (Encapsulated)
- Up to 20 servers are supported

Parameter	Description
Modbus Commands Supported (client and server)	1: Read Coil Status 2: Read Input Status 3: Read Holding Registers 4: Read Input Registers 5: Force (Write) Single Coil 6: Preset (Write) Single Holding Register 15: Force (Write) Multiple Coils 16: Preset (Write) Multiple Holding Registers 22: Mask Write Holding Register (Slave Only) 23: Read/Write Holding Registers (Slave Only)
Configurable Parameters: (client and server)	<ul style="list-style-type: none"> ▪ Gateway IP Address ▪ PLC Read Start Register (%MW) ▪ PLC Write Start Register (%MW) ▪ Number of MBAP and MBTCP servers ▪ Gateway Modbus Read Start Address ▪ Gateway Modbus Write Start Address
Configurable Parameters: (client only)	<ul style="list-style-type: none"> ▪ Minimum Command Delay ▪ Response Timeout ▪ Retry Count ▪ Command Error Pointer
Command List	Up to 160 Modbus commands (one tag per command)
Status Data	<ul style="list-style-type: none"> ▪ Error codes reported individually for each command. ▪ High-level status data available from Modbus TCP/IP client (for example PLC)
Command List Polling	Each command can be individually enabled or disabled; write-only-on-data-change is available

6.1.2 MBTCP Internal Database

The internal database is central to the functionality of the PLX3x gateway. The gateway shares this database between all the communications ports on the gateway and uses it as a conduit to pass information from one protocol to another device on one network to one or more devices on another network. This permits data from devices on one communication port to be accessed and controlled by devices on another communication port.

In addition to data from the client and server, you can map status and error information generated by the gateway into the user data area of the internal database. The internal database is divided into two areas:

- Upper memory for the module status data area. This is where the module writes internal status data for the protocols supported by the module.

- Lower memory for the user data area. This is where incoming data from external devices is stored and accessed.

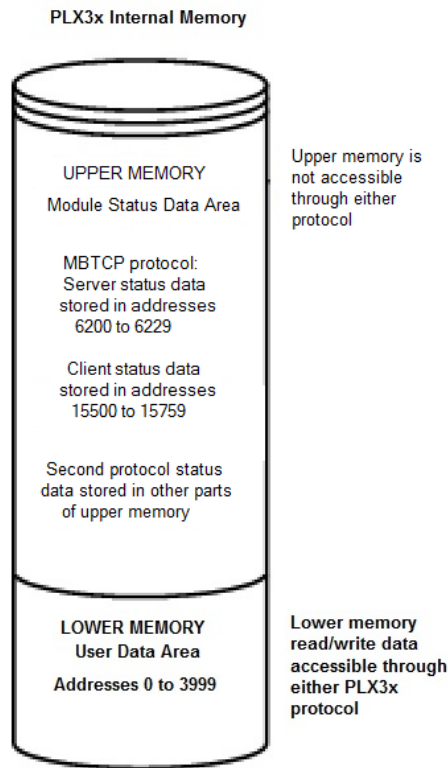

Either protocol in the PLX3x gateway can write data to and read data from the user data area.

- If the module is acting as a client/master, you create commands to read data from external client/server devices and store the data in a specific location in the user data area.
- If the module is acting as a server/slave, the external client/master devices write data to a specific location in the user data area.

Note: If you want to access module status data in the upper memory, you can use the data mapping feature in the gateway to copy data from the module status data area to the user data area. See Mapping Data in Module Memory (page 21). Otherwise, you can use the diagnostic functions in ProSoft Configuration Builder to view module status data. For more information on the module status data, see Network Diagnostics (page 104).

Modbus TCP/IP Client Access to Database

The client functionality exchanges data between the PLX3x gateway's internal database and data tables established in one or more Quantum processors or other server based devices. The command list that you define in ProSoft Configuration Builder specifies what data is to be transferred between the gateway and each of the servers on the network. No ladder logic is required in the processor (server) for client functionality, except to ensure that sufficient data memory exists.

The following illustration describes the flow of data between the Ethernet clients and the internal database.

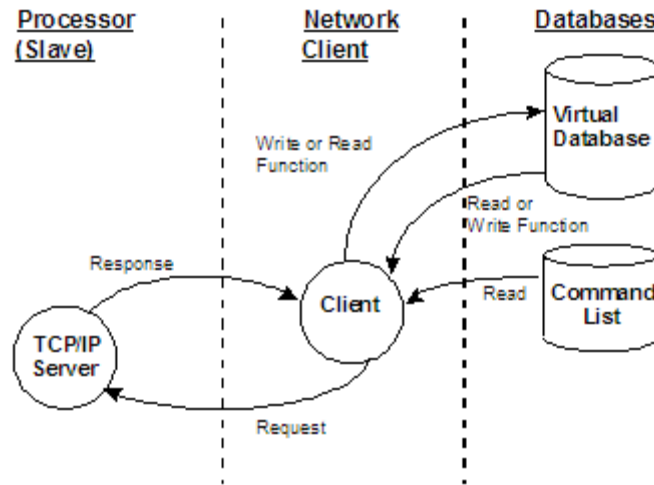

Multiple Server Access to Database

The MBTCP gateway provides server functionality using reserved Service Port 502 for Modbus TCP/IP MBAP messages, as well as Service Ports 2000 and 2001 to support the TCP/IP Encapsulated Modbus version of the protocol used by several HMI manufacturers. Server support in the gateway permits client applications (for example: HMI software, Quantum processors, etc) to read from and write to the gateway's database. This section discusses the requirements for attaching to the gateway using client applications.

The server driver supports multiple concurrent connections from several clients. Up to five clients can simultaneously connect on Service Port 502 and five more can simultaneously connect on Service Port 2000. The MBTCP protocol uses Service Port 2001 to pass Encapsulated Modbus commands through from the Ethernet port to the gateway's serial port.

When configured as a server, the gateway uses its internal database as the source for read requests and the destination for write requests from remote clients. Access to the database is controlled by the command type received in the incoming message from the client. The following table specifies the relationship of the gateway's internal database to the addresses required in the incoming Modbus TCP/IP requests.

Database Address	Modbus Address
0	40001
1000	41001
2000	42001
3000	43001
3999	44000

The following virtual addresses are not part of the normal gateway user database and are not valid addresses for standard data. However, these addresses may be used for incoming commands that are requesting floating-point data.

To use addresses in this upper range requires that you configure the following parameters in *Prosoft Configuration Builder (PCB)*:

- Set the *Float Flag* in the MBTCP server configuration to **YES**
- Set the *Float Start* to a database address in the range below
- Set the *Float Offset* to a database address in the gateway user memory area shown above.

Remember that, once this is done, all data above the *Float Start* address must be floating-point data. See *Configuring MBTCP Servers* (page 97).

Database Address	Modbus Address
4000	44001
5000	45001
6000	46001
7000	47001
8000	48001
9000	49001
9999	50000

The gateway must be correctly configured and connected to the network before any attempt is made to use it. Use a network verification program, such as *ProSoft Discovery Service* or the command prompt PING instruction, to verify that other devices can find the gateway on the network. Use *ProSoft Configuration Builder* to confirm proper configuration of the gateway and to transfer the configuration files to and from the gateway.

Modbus Message Routing: Port 2001

When Modbus messages are sent to the PLX3x gateway over the TCP/IP connection to port 2001, the messages are routed by the gateway directly out the serial communication port (Port 0, if it is configured as a Modbus master). The commands (whether a read or a write command) are immediately routed to the slave devices on the serial port. Response messages from the slave devices are routed by the gateway to the TCP/IP network to be received by the originating host.

6.2 MBTCP Configuration

6.2.1 Configuring MBTCP Servers

This section contains database offset information used by the PLX3x gateway MBTCP server when accessed by external clients. You can use these offsets to segment the database by data type.

To configure the MBTCP Servers in PCB

- 1 In *ProSoft Configuration Builder*, click the **[+]** next to the gateway, then click the **[+]** next to *MBTCP Servers*.

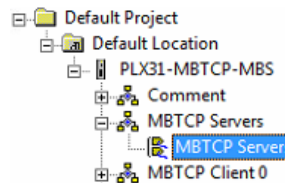

- 2 Double-click the second *MBTCP Servers* to display the *Edit - MBTCP Servers* dialog box.
- 3 In the dialog box, click a parameter and then enter a value for the parameter. Note that the *Float Start* and *Float Offset* parameters only appear if you set *Float Flag* to *Yes*.

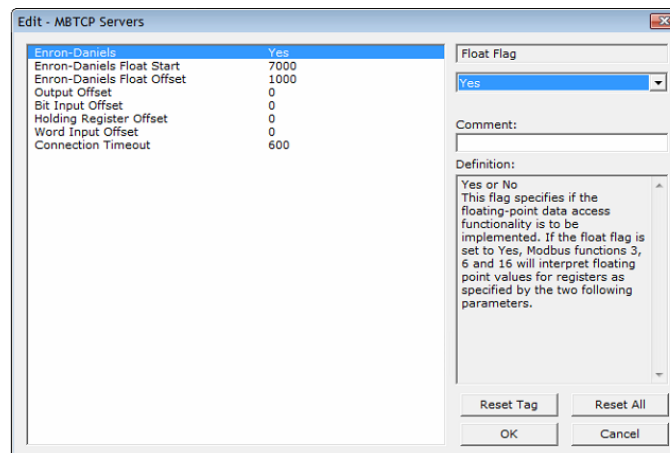

Parameter	Value	Description
Float Flag (Enron-Daniels)	Yes or No	Specifies if the floating-point data access functionality is active. Yes - Modbus functions 3, 6, and 16 interpret floating-point values for registers as specified by <i>Float Start</i> and <i>Float Offset</i> . No - The gateway does not use floating point functionality.
Float Start	0 to 65535	This parameter only appears if <i>Float Flag</i> is Yes. Specifies the first register of floating-point data if <i>Float Flag</i> is Yes. All requests with register values greater than or equal to this value are considered floating-point data requests. For example, if you enter 7000, the gateway considers all requests for registers 7000 and above as floating-point data.
Float Offset	0 to 3999	This parameter only appears if <i>Float Flag</i> is Yes. Specifies the start register for floating-point data in the internal database. For example, if you enter 3000 and set <i>Float Start</i> to 7000, data requests for register 7000 will use the internal Modbus register 3000.
Output Offset	0 to 3999	This parameter applies if the port is configured as a slave. Specifies the internal database address to use as the zero address or starting point for binary output Coil data. Coil data is read by Modbus Function Code 1 commands (Read Coils) and written by Function Codes 5 (Force Single Coil) or Function Code 15 (Force Multiple Coils). For example, if you set this parameter to 50 and the gateway receives a Function Code 1 command requesting Coil address 0 (virtual Modbus Coil address 00001 or 000001), the gateway returns the value at register 50, bit 0 in the gateway's database.
Bit Input Offset	0 to 3999	Specifies the offset address in the internal Modbus database for network requests for Modbus function 2 commands. For example, if you set this value to 150, an address request of 0 returns the value at register 150 in the database.
Holding Register Offset	0 to 3999	Specifies the offset address in the internal Modbus database for network requests for Modbus functions 3, 6, or 16 commands. For example, if you set this value to 50, an address request of 0 returns the value at register 50 in the database.
Word Input Offset	0 to 3999	Specifies the offset address in the internal Modbus database for network requests for Modbus function 4 commands. For example, if you set the value to 150, an address request of 0 returns the value at register 150 in the database.
Connection Timeout	0 to 1200	Specifies the number of seconds the server waits to receive new data. If the server does not receive any new data during this time, it closes the connection.

6.2.2 Configuring MBTCP Client [x]

The *MBTCPClient [x]* section of the configuration specifies the parameters for the client to be emulated on the gateway. The command list for the client is entered in a separate section.

To configure the MBTCP Client [x] in PCB

- 1 In *ProSoft Configuration Builder*, click the **[+]** next to the gateway, then click the **[+]** next to *MBTCP Client [x]*.

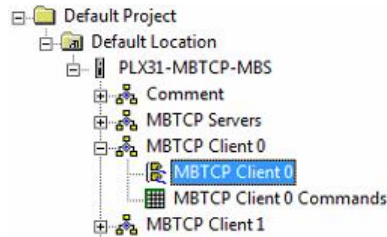

- 2 Double-click the second *MBTCP Client [x]* to display the *Edit - MBTCP Client [x]* dialog box.
- 3 In the dialog box, click a parameter and then enter a value for the parameter. Note that the *Float Start* and *Float Offset* parameters only appear if you set *Float Flag* to **YES**.

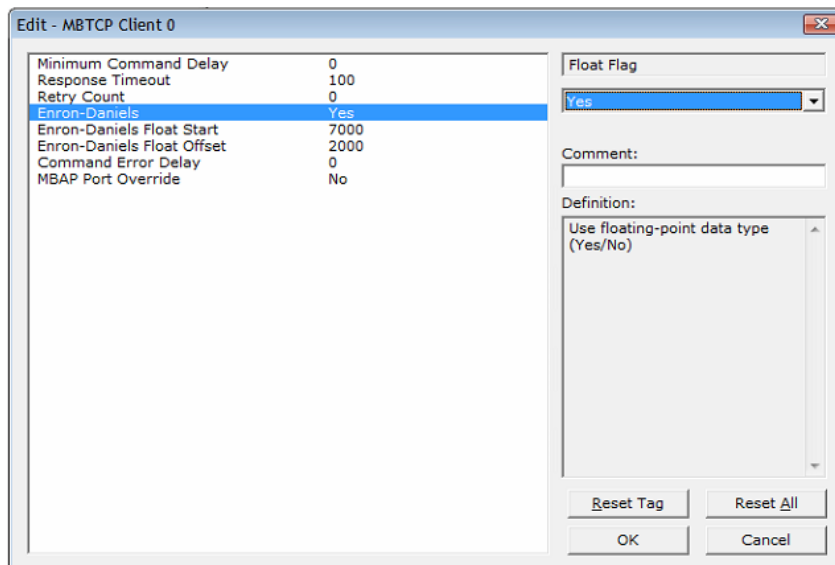

Parameter	Value	Description
Minimum Command Delay	0 to 32767	Specifies the number of milliseconds to wait between the initial issuance of a commands. You can use this to delay all commands sent to slaves to avoid "flooding" commands on the network. This parameter does not affect retries of a command as they will be issued when failure is recognized.
Response Timeout	0 to 65535	Specifies the time in milliseconds that a client waits before re-transmitting a command if no response is received from the addressed server. The value you use depends on the type of communication network, and the expected response time of the slowest device on the network.
Retry Count	0 to 10	Specifies the number of times the gateway retries a command if it fails.
Float Flag (Enron-Daniels)	Yes or No	Specifies if the floating-point data access functionality is active. Yes - Modbus functions 3, 6, and 16 interpret floating-point values for registers as specified by <i>Float Start</i> and <i>Float Offset</i> . No - The gateway does not use floating point functionality.
Float Start	0 to 32767	This parameter only appears if <i>Float Flag</i> is Yes. Specifies the first register of floating-point data. The gateway considers all requests with register values greater-than or equal to this value as floating-point data requests. For example, if you enter 7000, the gateway considers all requests for registers 7000 and above as floating-point data.
Float Offset	0 to 3998	This parameter only appears if <i>Float Flag</i> is Yes. Specifies the starting register for floating-point data in the gateway internal database. For example: <ul style="list-style-type: none"> ▪ If you set <i>Float Offset</i> to 3000 and set <i>Float Start</i> to 7000, the gateway returns data as floating-point data for register 47001 (or 407001) actually comes from internal gateway registers 3000 and 3001. ▪ If the requested address is 47002 (407002), the gateway returns data from internal registers 3002 and 3003. ▪ If the requested address is 47101 (407101), the gateway returns data from internal registers 3200 and 3201; and so on.
Command Error Delay	0 to 300	Specifies the number of 100 millisecond intervals to turn off a command in the error list after an error is recognized for the command. If you set this to 0, there is no delay.
MBAP Port Override	Yes or No	Specifies whether to override the default port settings. Yes - The gateway uses MBAP format messages for all Server Port values. The gateway does not use RTU through TCP. No - The gateway uses standard Server Port 502 with MBAP format messages. All other Server Port values use encapsulated Modbus message format (RTU through TCP).

6.2.3 Configuring MBTCP Client [x] Commands

The *MBTCP Client [x] Commands* section defines the Modbus TCP/IP commands to be issued from the gateway to server devices on the network. You can use these commands for data collection and/or control of devices on the TCP/IP network.

To configure the MBTCP Client [x] commands in PCB

- 1 In *ProSoft Configuration Builder*, click the **[+]** next to the gateway, then click the **[+]** next to *MBTCP Client [x]*.

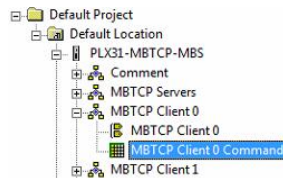

- 2 Double-click *MBTCP Client [x] Commands* to display the *Edit - MBTCP Client [x] Commands* dialog box.
- 3 In the dialog box, click **ADD ROW** to add a command, then click **EDIT ROW** to enter values for the command.

You must construct a command list in order to interface the PLX3x gateway with Modbus TCP/IP server devices. The commands in the list specify the server device to be addressed, the function to be performed (read or write), the data area in the device to interface with and the registers in the internal database to be associated with the device data. The client command list supports up to 16 commands per client. The gateway processes the command list from top (command #0) to bottom.

The following table describes the command list configuration parameters:

Parameter	Value	Description
Enable	YES NO CONDITONAL	Specifies if the command is to be executed and under what conditions. No (0) - the command is disabled and is not executed in the normal polling sequence. YES (1) - the command is executed upon each scan of the Command List if the <i>Poll Interval</i> is set to zero (0). If the <i>Poll Interval</i> is set to a non-zero value, the command is executed when the interval timer for that command expires. CONDITIONAL (2) - the command is executed only if the internal bit data associated with the command changes. This parameter is valid for write commands (FC 5, 6, 15 and 16).
Internal Address	0 to 3999 (for register-level addressing) or 0 to 63999 (for bit-level addressing)	Specifies the database address in the gateway's internal database to use as the destination for data from a read command, or as the source for data sent by a write command. The database address is interpreted as a bit address or a 16-bit register (word) address, depending on the Modbus Function Code used in the command. <ul style="list-style-type: none"> ▪ For Modbus functions 1, 2, 5, and 15, this parameter is interpreted as a bit-level address. ▪ For Modbus functions 3, 4, 6, and 16, this parameter is interpreted as a register-level address.

Parameter	Value	Description
Poll Interval	0 to 65535	Specifies the minimum interval between executions of continuous commands. The value is in tenths of a second. If you enter a value of 100, the command executes no more frequently than once every 10 seconds.
Reg Count	1 to 125 (for registers) or 1 to 800 (for coils)	Specifies the number of 16-bit registers or binary bits to be transferred by the command. <ul style="list-style-type: none"> ▪ Modbus functions 5 and 6 ignore this field as they apply only to a single data point. ▪ For Modbus functions 1, 2, and 15, this parameter sets the number of bits (inputs or coils) transferred by the command. ▪ For Modbus functions 3, 4, and 16, this parameter sets the number of registers transferred by the command.
Swap Code	No Change Word Swap Word and Byte Swap Byte Swap	Specifies if and how the order of bytes in data received or sent is to be rearranged. Different manufacturers store and transmit multi-byte data in different combinations. You can use this parameter when dealing with floating-point or other multi-byte values, as there is no standard method of storing these data types. You can set this parameter to rearrange the byte order of data received or sent into an order more useful or convenient for other applications. NO CHANGE (0) - No change is made in the byte ordering (1234 = 1234). WORD SWAP (1) -The words are swapped (1234=3412). WORD AND BYTE SWAP (2) - The words are swapped, then the bytes in each word are swapped (1234=4321). BYTE SWAP (3) - The bytes in each word are swapped (1234=2143). These swap operations affect 4-byte (2-word) groups of data. Therefore, data swapping using <i>Swap Codes</i> should be done only when using an even number of words, such as 32-bit integer or floating-point data.
Node IP Address	xxx.xxx.xxx.xxx	IP address of the device being addressed by the command.
Serv Port	502 or other supported port on server	Service Port on which communication will occur. Use a value of 502 when addressing Modbus TCP/IP servers that are compatible with the Schneider Electric MBAP specifications (this will be most devices). If the server device supports another Service Port, enter the Service Port value for this parameter.
Slave Address	1 to 255 (0 is a broadcast)	Specifies the node address of a remote Modbus Serial device through a Modbus Ethernet to Serial converter. Note: Most Modbus devices only accept addresses in the range of 1 to 247, so check with the slave device manufacturer to see if the slave device can use addresses 248 to 255. If the value is set to zero, the command will be a broadcast message on the network. The Modbus protocol permits broadcast commands for <i>write</i> operations. Do not use node address 0 for <i>read</i> operations.
Modbus Function	1, 2, 3, 4, 5, 6, 15, or 16	Specifies the Modbus Function Code to be executed by the command. These function codes are defined in the Modbus protocol. More information on the protocol is available from www.modbus.org (http://www.modbus.org) or see About the Modbus Protocol (page 108). The following function codes are supported by the gateway. <ul style="list-style-type: none"> 1 - Read Coil Status 2 - Read Input Status 3 - Read Holding Registers 4 - Read Input Registers 5 - Force (Write) Single Coil

Parameter	Value	Description
		<p>6 - Preset (Write) Single Register 15 - Force Multiple Coils 16 - Preset Multiple Registers</p>
MB Address in Device	Varies	<p>Specifies the starting Modbus register or bit address in the server to be used by the command. Refer to the documentation of each Modbus server device for the register and bit address assignments valid for that device.</p> <p>The Modbus Function Code determines whether the address is a register-level or bit-level OFFSET address into a given data type range. The offset is the target data address in the server minus the base address for that data type. Base addresses for the different data types are:</p> <ul style="list-style-type: none"> ▪ 00001 or 000001 (0x0001) for bit-level Coil data (Function Codes 1, 5, and 15). ▪ 10001 or 100001 (1x0001) for bit-level Input Status data (Function Code 2) ▪ 30001 or 300001 (3x0001) for Input Register data (Function Code 4) ▪ 40001 or 400001 (4x0001) for Holding Register data (Function Codes 3, 6, and 16). ▪ Address calculation examples: <ul style="list-style-type: none"> ▪ For bit-level Coil commands (FC 1, 5, or 15) to read or write a Coil 0X address 00001, specify a value of 0 (00001 - 00001 = 0). ▪ For Coil address 00115, specify 114 (00115 - 00001 = 114) ▪ For register read or write commands (FC 3, 6, or 16) 4X range, for 40001, specify a value of 0 (40001 - 40001 = 0). ▪ For 01101, 11101, 31101 or 41101, specify a value of 1100. (01101 - 00001 = 1100) (11101 - 10001 = 1100) (31101 - 30001 = 1100) (41101 - 40001 = 1100) <p>Note: If the documentation for a particular Modbus server device lists data addresses in hexadecimal (base16) notation, you must convert the hexadecimal value to a decimal value for this parameter. In such cases, it is not usually necessary to subtract 1 from the converted decimal number, as this addressing scheme typically uses the exact offset address expressed as a hexadecimal number.</p>
Comment		Optional 32 character comment for the command.

6.3 Network Diagnostics

6.3.1 MBTCP PCB Diagnostics

The best way to troubleshoot the MBTCP driver is to use ProSoft Configuration Builder to access the diagnostic capabilities of the gateway through the Ethernet debug port. For instructions on how to access the diagnostics, see Diagnostics and Troubleshooting (page 27).

The following table summarizes the status information available in PCB for the MBTCP driver:

Connection Type	Submenu Item	Description
MBTCP Server	Config	Configuration settings for Server Connections.
	Comm Status	Status of the Server Connections. Displays a summary of the requests, responses, and errors.
MBTCP Client [x]	Config	Configuration settings for Client [x] Connections.
	Comm Status	Status information for Client [x] commands. Displays a summary of all the errors resulting from Client [x] commands.
	Modbus Commands	Configuration for the Client [x] Modbus command list.
	Modbus Cmd Errors (Decimal)	Current error codes for each command on the Client [x] command list in decimal number format. A zero means there is currently no error for the command.
	Modbus Cmd Errors (Hex)	Current error codes for each command on the Client [x] command list in hexadecimal number format. A zero means there is currently no error for the command.

6.3.2 MBTCP Status Data in Upper Memory

The MBTCP driver has an associated status data area located in the PLX3x gateway's upper memory. The Data Map functionality of the PLX3x gateway can be used to map this data into the normal user data range of the PLX3x gateway's database.

Note that all the status values are initialized to zero (0) at power-up, cold boot and during warm boot.

MBTCP Server Status Data

The following table lists the addresses in upper memory where the PLX3x gateway stores status data for MBTCP servers:

Server Port	Address Range
2000	11000 through 11009
502	11010 through 11019
2001	11020 through 11029

The content of each server's status data area is structured the same. The following table describes the content of each register in the status data area:

Offset	Description
0	Number of Command Requests
1	Number of Command Responses
2	Number of Command Errors
3	Number of Requests
4	Number of Responses
5	Number of Errors Sent
6	Number of Errors Received
7	Configuration Error Word
8	Current Error Code
9	Last Error Code

MBTCP Client Status Data

The following table lists the addresses in upper memory where the PLX3x gateway stores status data for each MBTCP Client:

Client	Address Range
0	12000 through 12025
1	12026 through 12051
2	12052 through 12077
.	.
.	.
8	12208 through 12233
9	12234 through 12259

The content of each Client's status data area is structured the same. The following table describes the content of each register in the status data area:

Offset	Description
0	Command Request Count (total Client commands sent)
1	Command Response Count (total command responses received)
2	Command Error Count
3	Number of Request Packets
4	Number of Response Packets
5	Errors Sent
6	Errors Received
7	Reserved
8	Current Error
9	Last Error

- Offsets 8 and 9 contain information about the most recent communication errors.
- The Current Error (offset 8) has a non-zero value if the currently executing client command experiences an error.
- The Last Error (offset 9) stores the most recent non-zero value error code that was reported by the client the last time it experienced an error. Note that this value is protected. This register holds the last error value until you clear the memory by a restart, reset, cold-boot, or warm-boot operation. Therefore, any value here may be from an error that occurred at any time since the PLX3x gateway was last restarted.

MBTCP Client Command List Error Data

The PLX3x gateway stores a status/error code in upper memory for each command in each MBTCP client’s command list. The following table lists the addresses in upper memory where the PLX3x gateway stores the command list error data for each MBTCP Client:

Client	Address Range
0	15510 to 15525
1	15536 to 15551
2	15562 to 15577
.	.
.	.
8	15718 to 15733
9	15744 to 15759

The first word in each client’s command list error data area contains the status/error code for the first command in the client’s Command List. Each successive word in the Command Error List is associated with the next command in the client Command List. Therefore, the number of valid error values depends on on the number of commands defined.

The structure of the command list error data area (which is the same for all Clients) is displayed in the following table:

Offset	Description
0	Command #1 Error Code
1	Command #2 Error Code
2	Command #3 Error Code
.	.
.	.
13	Command #14 Error Code
14	Command #15 Error Code
15	Command #16 Error Code

A non-zero error code for a command indicates an error.

6.3.3 MBTCP Error Codes

Standard Modbus Exception Code Errors

These error codes are generated or returned on both the Controller and slave ports. These codes are the standard Modbus errors.

Code	Description
1	Illegal Function
2	Illegal Data Address
3	Illegal Data Value
4	Failure in Associated Device
5	Acknowledge
6	Busy, Rejected Message

MBTCP Client Specific Errors

These error codes are specific to the MBTCP client.

Code	Description
-33	Failed to connect to server specified in command
-35	Wrong message length in the response
-36	MBTCP command response timeout (same as -11)
-37	TCP/IP connection ended before session finished

MBTCP Communication Error Codes

The gateway detects these command-specific error codes during initial command list loading at gateway power-up or reset and are stored in the *Command Error List* memory region.

Code	Description
-2	Timeout while transmitting message
-11	Timeout waiting for response after request (same as -36)
253	Incorrect slave/server address in response
254	Incorrect function code in response
255	Invalid CRC/LRC value in response

MBTCP Command List Error Codes

The PLX3x gateway detects these command-specific error codes during initial command list loading at PLX3x gateway power-up or reset and are stored in the *Command Error List* memory region.

Code	Description
-40	Too few parameters
-41	Invalid enable code
-42	Internal address > maximum address
-43	Invalid node address (<0 or >255)
-44	Count parameter set to 0
-45	Invalid function code
-46	Invalid swap code

6.4 MBTCP Reference

6.4.1 About the Modbus Protocol

Modbus is a widely-used protocol originally developed by Modicon in 1978. Since that time, the protocol has been adopted as a standard throughout the automation industry.

The original Modbus specification uses a serial connection to communicate commands and data between master and server devices on a network. Later enhancements to the protocol allow communication over Ethernet networks using TCP/IP as a "wrapper" for the Modbus protocol. This protocol is known as Modbus TCP/IP.

Modbus TCP/IP is a client/server protocol. The master establishes a connection to the remote server. When the connection is established, the master sends the Modbus TCP/IP commands to the server. The PLX3x gateway simulates up to 30 masters, and works both as a master and a server.

Aside from the benefits of Ethernet versus serial communications (including performance, distance, and flexibility) for industrial networks, the Modbus TCP/IP protocol allows for remote administration and control of devices over an Internet connection. It is important to note that not all Internet protocols are implemented in the module; for example, HTTP and SMTP protocols are not available. Nevertheless, the efficiency, scalability, and low cost of a Modbus TCP/IP network make this an ideal solution for industrial applications.

The PLX3x gateway acts as an input/output module between devices on a Modbus TCP/IP network and the Rockwell Automation backplane and processor. The module uses an internal database to pass data and commands between the processor and the master and server devices on the Modbus TCP/IP network.

Supported Function Codes

The format of each command in the list depends on the Modbus Function Code being executed. The following table lists the Function Codes supported by the PLX3x gateway.

Function Code	Definition	Supported as master	Supported as server
1	Read Coil Status 0x	X	X
2	Read Input Status 1x	X	X
3	Read Holding Registers 4x	X	X
4	Read Input Registers 3x	X	X
5	Set Single Coil 0x	X	X
6	Single Register Write 4x	X	X
8	Diagnostics		X
15	Multiple Coil Write 0x	X	X
16	Multiple Register Write 4x	X	X
17	Report Slave ID		X
22	Mask Write 4X		X
23	Read/Write		X

Each command list record has the same general format. The first part of the record contains the information relating to the communication module and the second part contains information required to interface to the Modbus server device.

7 MBS Protocol

In This Chapter

- ❖ MBS Functional Overview 111
- ❖ MBS Configuration 115
- ❖ MBS Diagnostics 123
- ❖ MBS Reference 130

7.1 MBS Functional Overview

You can use the the PLX3x gateway Modbus Serial (MBS) protocol for both master and slave connections. Each of the gateway serial port(s) is individually configurable to communicate to separate networks.

- As a master, you can specify a command list of up to 100 entries. The gateway stores the write command data in the gateway's lower memory. This is also where the gateway stores data from read commands from other devices. See MBS Internal Database (page 113) for more information.
- As a slave, data in the lower memory of the gateway's internal database is accessible for read and write operations by a remote Modbus master.

The following illustration shows the functionality of the Modbus TCP/IP protocol:

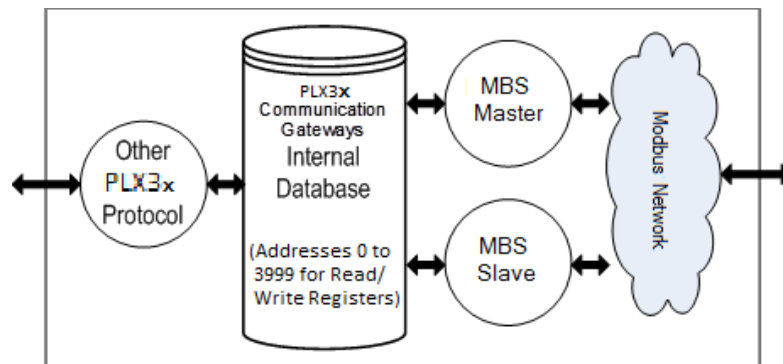

7.1.1 Modbus Serial Specifications

Command List	Up to 100 commands per Master port, each fully configurable for Function Code, slave address, register to/from addressing and word/bit count.
Supported Modbus Function Codes	1: Read Coil Status 2: Read Input Status 3: Read Holding Registers 4: Read Input Registers 5: Force (Write) Single Coil 6: Preset (Write) Single Holding Register 15: Force (Write) Multiple Coils 16: Preset (Write) Multiple Holding Registers
Polling of Command List	Configurable polling of command list, including continuous and on change of data, and dynamically user or automatic enabled.
Status Data	Error codes available on an individual command basis. In addition, a slave status list is maintained per active Modbus Master port.
Node Address	1 to 247 (software selectable)
RS Interface	RS232, RS422, and RS485

7.1.2 Modbus Master/Slave Port Specifications

Type	Specifications
General Parameters	
Internal Database	Up to 4000 registers (words) available.
Communication parameters	Port 0: Baud Rate: 110 to 115K baud Port 1, 2, 3: Baud Rate: 110 to 115K baud Stop Bits: 1 or 2 Data Size: 5 to 8 bits Parity: None, Even, Odd RTS Timing delays: 0 to 65535 milliseconds
Modbus Modes	RTU mode (binary) with CRC-16 ASCII mode with LRC error checking
Floating Point Data	Floating point data movement supported, including configurable support for Enron implementation

Type	Specifications
Modbus Function Codes	1: Read Coil Status 2: Read Input Status 3: Read Holding Registers 4: Read Input Registers 5: Force (Write) Single Coil 6: Preset (Write) Single Register 15: Force(Write) Multiple Coils 16: Force (Write) Multiple Register 22: Mask Write Holding Register (Slave Only) 23: Read/Write Holding Registers (Slave Only)
Modbus Master	
Command List	Up to 100 command per Master port, each fully configurable for function, slave address, register to/from addressing and word/bit count
Status Data	Error codes available on an individual command basis. In addition, a slave status list is maintained per active Modbus Master port.
Polling of command list	Configurable polling of command list, including continuous and on change of data
Modbus Slave	
Node address	1 to 247 (software selectable)
Status Data	Error codes, counters and port status available per configured slave port starting at register 4400.

7.1.3 MBS Internal Database

The internal database is central to the functionality of the PLX3x gateway. The gateway shares this database between all the communications ports on the gateway and uses it as a conduit to pass information from one protocol to another device on one network to one or more devices on another network. This permits data from devices on one communication port to be accessed and controlled by devices on another communication port.

In addition to data from the client and server, you can map status and error information generated by the gateway into the user data area of the internal database. The internal database is divided into two areas:

- Upper memory for the module status data area. This is where the module writes internal status data for the protocols supported by the module.
- Lower memory for the user data area. This is where incoming data from external devices is stored and accessed.

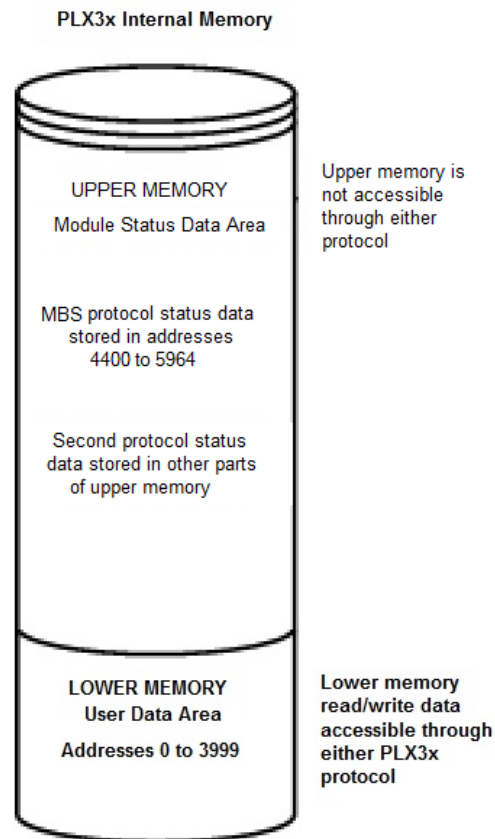

Either protocol in the PLX3x gateway can write data to and read data from the user data area.

- If the module is acting as a client/master, you create commands to read data from external client/server devices and store the data in a specific location in the user data area.
- If the module is acting as a server/slave, the external client/master devices write data to a specific location in the user data area.

Note: If you want to access module status data in the upper memory, you can use the data mapping feature in the gateway to copy data from the module status data area to the user data area. See Mapping Data in Module Memory (page 21). Otherwise, you can use the diagnostic functions in ProSoft Configuration Builder to view module status data. For more information on the module status data, see MBS Diagnostics (page 123).

Modbus Port Access to Database

The multiple slave support in the PLX3x gateway permits remote master applications (such as HMI software and Quantum processors) to read from, and write to the gateway's database.

When you configure the gateway as a slave, its internal database is the source for read requests and the destination for write requests from remote masters. Access to the database is controlled by the command type in the incoming message from the remote master. The following table defines the relationship of the gateway's internal database to the addresses required in the incoming Modbus requests.

Database Address	Modbus Address
0	40001 (five-digit addressing) or 400001 (six-digit addressing)
1000	41001 or 410001
2000	42001 or 420001
3000	43001 or 430001
3999	44000 or 440000

7.2 MBS Configuration

7.2.1 Configuring MBS Port [x]

The Modbus Port [x] sections of the **PCB Tree Window**, where x stands for 1, 2, 3 or 4, set the Modbus master and slave port communication parameters and specify the protocol-specific settings.

To configure the MBS Port [x] in PCB

- 1 In *ProSoft Configuration Builder*, click the **[+]** next to the gateway, then click the **[+]** next to *MBS Port [x]*.

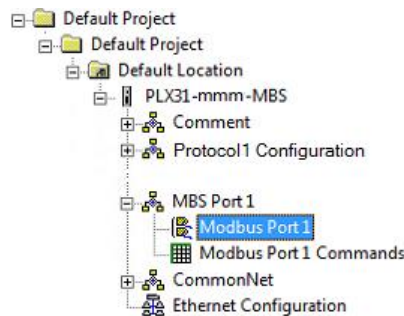

- 2 Double-click the *Modbus Port [x]* to display the *Edit - Modbus Port [x]* dialog box.

- 3 In the dialog box, click a parameter and then enter a value for the parameter. Note that the *Float Start* and *Float Offset* parameters only appear if you set *Float Flag* to **YES**.

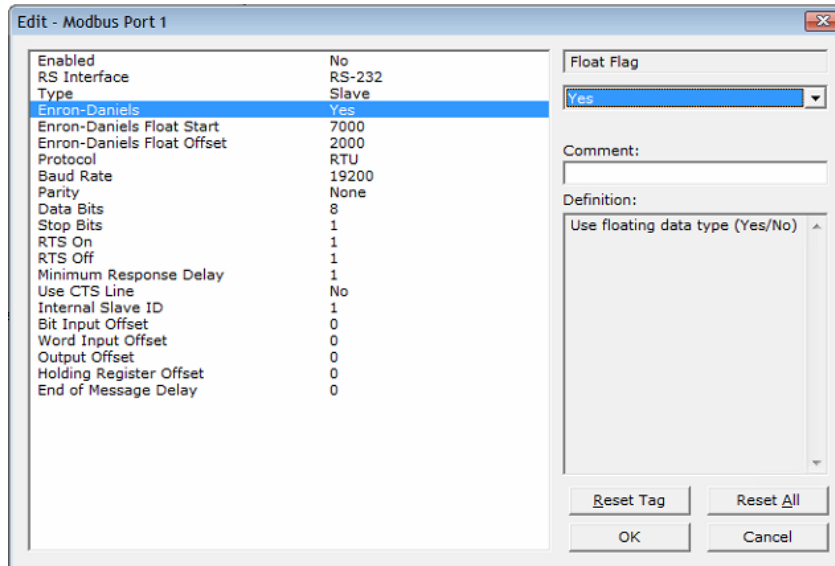

Configuration Parameters Common to Master and Slave

Parameter	Value	Description
Enabled	Yes or No	Specifies if the port will be used. No - The gateway does not use the port. Yes - The gateway uses the port.
RS Interface	RS-232 RS-485 RS-422	Specifies the electrical interface for the ports.
Type	Master or Slave	Specifies if the port emulates a master or slave device. MASTER - The gateway initiates Modbus commands to one or more Modbus devices SLAVE - The gateway responds to Modbus commands initiated by a Modbus master
Float Flag (Enron-Daniels)	Yes or No	This parameter only appears if <i>Float Flag</i> is Yes. Specifies if the gateway implements floating-point data access. If the float flag is set to Yes, Modbus functions 3, 6, and 16 interpret floating-point values for registers as specified by the two following parameters (<i>Float Start</i> and <i>Float Offset</i>).
Float Start	0 to 32767	This parameter only appears if <i>Float Flag</i> is Yes. Specifies the first register of floating-point data. All requests with register values greater than or equal to this value are considered floating-point data requests. For example, if you enter a value of 7000, the gateway considers all requests for registers 7000 and above will as floating-point data.
Float Offset	0 to 3998	This parameter only appears if <i>Float Flag</i> is Yes. Specifies the start register for floating-point data in the internal database. For example, if you enter a value of 3000 and set the <i>Float Start</i> parameter to 7000, data requests for register 7000 use the internal Modbus register 3000.
Protocol	RTU or ASCII	Specifies the Modbus protocol version for the port.
Baud Rate	Various	Specifies the baud rate for the port.
Parity	None Odd Even	Specifies the type of parity checking to use. Parity is a simple error checking algorithm used in serial communication. All devices communicating through this port must use the same parity setting.
Data Bits	7 or 8	Specifies the number of data bits for each word for the protocol. All devices on this port must use the same number of data bits.
Stop Bits	1 or 2	Specifies the number of stop bits that signal the end of a character in the data stream. For most applications, use one stop bit. For slower devices that require more time to re-synchronize, use two stop bits. All devices on this port must use the same number of stop bits.
RTS On	0 to 65535	Specifies the number of milliseconds to delay data transmission after <i>Ready To Send</i> (RTS) is asserted.
RTS Off	0 to 65535	Specifies the number of milliseconds to delay after the last byte of data is sent before the RTS modem signal is set low.
Use CTS Line	YES or NO	Specifies if the <i>Clear To Send</i> (CTS) modem control line is used or not. No - The gateway does not monitors the CTS line. Yes - The gateway monitors the CTS line and it must be high before the gateway sends data. Normally, this parameter is required when half-duplex modems are used for communication (2-wire). This procedure is commonly referred to as <i>hardware handshaking</i> .

MBS Master Configuration Parameters

Parameter	Value	Description
Response Timeout	0 to 65535	Specifies the command response timeout period in 1 millisecond increments. This is the time that a port configured as a Master waits for a response from the addressed slave before re-transmitting the command or skipping to the next command in the Command List (see <i>Retry Count</i>). The value to specify depends on the communication network and the expected response time (plus or minus) of the slowest device on the network.
Retry Count	0 to 10	Specifies the number of times the gateway retries a command if it fails.
End of Message Delay	0 to 65535	Specifies a time delay in milliseconds added to the 3.5 character time delay used by the module to recognize the end of a message. Certain applications may require validation of Modbus messages with more than 3.5 character time between consecutive bytes (for example, modem applications). A value of 0 causes the gateway to use the default end of message delay.
Minimum Command Delay	0 to 32767	Specifies the number of milliseconds the gateway waits between receiving the end of a slave's response to the most recently transmitted command and the issuance of the next command. You can use this parameter to place a delay after each command to avoid sending commands on the network faster than the slaves can receive them. This parameter does not affect retries of a command, as the gateway issues retries when a command failure is recognized.
Error Delay Counter	0 to 60000	Specifies the number of poll attempts to be skipped before trying to re-establish communications with a slave that has failed to respond to a command within the time limit set by <i>Response Timeout</i> . After the slave fails to respond, the master skips sending commands that would have been sent to the slave until the number of skipped commands matches the value entered in this parameter. This creates a sort of <i>slow poll mode</i> for slaves that are experiencing communication problems.
Command Control Reg	-1, 0 to 3900	<p>This parameter allows the execution of commands in the Command List to be controlled by setting a value of zero (0), one (1), two (2), or three (3) into a 100-register area of the gateway database, beginning at the address entered in this parameter.</p> <ul style="list-style-type: none"> ▪ If you specify an Enable code of zero (0) for all the commands in the list, then no commands are executed. ▪ If you change the value in the first control register to one (1), the gateway executes command zero continuously. ▪ If you set the value is the control register for a write command two (2), the command is enabled for conditional writing, which causes the gateway to execute the command whenever the values in the database registers associated with the command change. Use the value of three (3) only for bit-level write commands, FC 5 and 15. If you set the parameter to three (3), the command is executed only if the internal bit data associated with the command changes. It also clears the bit or bits in the internal database after the write command is built. ▪ To use this feature, configure the commands as disabled (enable code = 0). ▪ This Command Control feature can be disabled by setting this parameter to a value of 0 to -1. <p>For information on the Command List, see MBS Port [x] Commands (page 120).</p>

MBS Slave Configuration Parameters

Parameter	Value	Description
Minimum Response Delay	0 to 65535	Specifies the number of milliseconds the gateway waits before responding to a command received on the port from a remote Master. This delay may be required to accommodate slower Master devices.
Internal Slave ID	0 to 247	Specifies the virtual Modbus slave address for the port. The gateway processes any commands received on the slave port, addressed to this address. Each slave device on the network must have a unique address.
Bit Input Offset	0 to 3998	Specifies the internal database address for the zero address or starting point for binary Input Status data. Input Status data is read-only data, requested by Modbus Function Code 2 commands (Read Input Status). For example, if you set this parameter to 150 and a Function Code 2 command is received requesting Input Status address 0 (virtual Modbus Address 10001 or 100001), the gateway returns the bit value at register 150, bit 0 in the gateway's database.
Word Input Offset	0 to 3998	Specifies the internal database address for the zero address or starting point for Input Register (16-bit integer) data. Input Register data is read-only data, requested by Modbus Function Code 4 commands (Read Input Registers). For example, if you set this parameter to 500 and a Function Code 4 command is received requesting Input Register address 0 (virtual Modbus address 30001 or 300001), the module returns the value at register 500 in the gateway's database.
Output Offset	0 to 3998	Specifies the internal database address for the zero address or starting point for binary output Coil data. Coil data is read by Modbus Function Code 1 commands (Read Coils) and written by Function Codes 5 (Force Single Coil) or Function Code 15 (Force Multiple Coils). For example, if you set this parameter to 50 and a Function Code 1 command is received requesting Coil address 0 (virtual Modbus Coil address 00001 or 000001), the gateway returns the value at register 50, bit 0 in the gateway's database.
Holding Register Offset	0 to 3998	Specifies the internal database address to for the zero address or starting point for Holding Register (16-bit integer) data. Holding Register data is read by Modbus Function Code 3 commands (Read Holding Registers) and written by Function Code 6 (Preset Single Register) or Function Code 16 (Preset Multiple Registers). For example, if you set this parameter to 1000 and a Function Code 3 command is received requesting Holding Register address 0 (virtual Modbus address 40001 or 400001), the gateway returns the value at register 1000 in the gateway's database.
End of Message Delay	0 to 65535	Specifies a time delay in milliseconds to be added to the 3.5 character time delay that the gateway uses to recognize the end of a message. Certain applications may require validation of Modbus messages with more than 3.5 character time between consecutive bytes (for example, modem applications). A value of 0 causes the gateway to use the default end of message delay.

7.2.2 MBS Port [x] Commands

Use the Modbus Port [x] Commands (where x can be 1, 2, 3 or 4) sections of the PCB tree Window to define a master serial port *Command List*. This list holds the parameters needed to poll slave devices attached to a Master port.

To configure the MBS Port [x] commands PCB

- 1 In *ProSoft Configuration Builder*, click the **[+]** next to the gateway, then click the **[+]** next to *MBS Port [x]*.

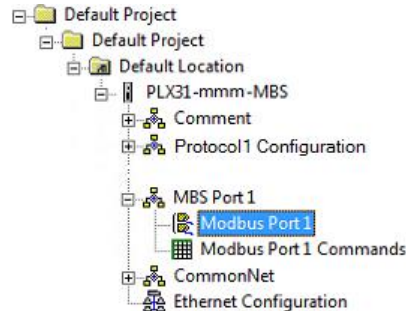

- 2 Double-click the *Modbus Port [x] Commands* to display the *Edit - Modbus Port [x] Commands* dialog box.
- 3 In the dialog box, click **ADD ROW** to add a command, then click **EDIT ROW** to enter values for the command.

Parameter	Value	Description
Enable	Disabled Continuous Event Command Conditional	Specifies if the command is to be executed and under what conditions. DISABLED (0) - The command is disabled and is not executed in the normal polling sequence. However, the command can still be activated using Command Control. CONTINUOUS (1) - The command is executed upon each scan of the Command List if you set <i>Poll Interval</i> to zero (0). If you set <i>Poll Interval</i> to a non-zero value, the gateway executes the command when the interval timer for that command expires. EVENT COMMAND (2) - The gateway executes the command only if the internal data associated with the command changes. This parameter is valid only for write commands (FC 5, 6, 15, and 16). CONDITIONAL (3) - The gateway executes the command only if the internal bit data associated with the command changes. It also clears the bit or bits in the internal database after the write command is built. This parameter is valid only for bit-level write commands (FC 5 and 15).
Internal Address	0 to 3999 (for register-level addressing) or 0 to 63999 (for bit-level addressing)	Specifies the database address in the gateway's internal database for the destination for data from a read command, or as the source for data for a write command. The database address is interpreted as a bit address or a 16-bit register (word) address, depending on the Modbus Function Code used in the command. <ul style="list-style-type: none"> ▪ For Modbus functions 1, 2, 5, and 15, this parameter is interpreted as a bit-level address. ▪ For Modbus functions 3, 4, 6, and 16, this parameter is interpreted as a register-level address.

Parameter	Value	Description
Poll Interval	0 to 65535	Specifies the minimum interval between executions of continuous commands, in seconds. If you enter a value of 10, the command executes no more frequently than once every 10 seconds.
Reg Count	1 to 125 (for registers) or 1 to 800 (for coils)	Specifies the number of 16-bit registers or binary bits to be transferred by the command. <ul style="list-style-type: none"> ▪ Modbus functions 5 and 6 ignore this field as they apply only to a single data point. ▪ For Modbus functions 1, 2, and 15, this parameter sets the number of bits (inputs or coils) to be transferred by the command. ▪ For Modbus functions 3, 4, and 16, this parameter sets the number of registers to be transferred by the command.
Swap Code	No Change Word Swap Word and Byte Swap Byte Swap	Specifies if and how the order of bytes in data received or sent is rearranged. This option allows for the fact that different manufacturers store and transmit multi-byte data in different combinations. This parameter is helpful when dealing with floating-point or other multi-byte values, as there is no one standard method of storing these data types. You can set <i>Swap Code</i> to rearrange the byte order of data received or sent into an order more useful or convenient for other applications. <p>NO CHANGE (0) - No change is made in the byte ordering (1234 = 1234)</p> <p>WORD SWAP (1) -The words are swapped (1234=3412)</p> <p>WORD AND BYTE SWAP (2) - The words are swapped, then the bytes in each word are swapped (1234=4321)</p> <p>BYTE SWAP (3) - The bytes in each word are swapped (1234=2143)</p> <p>These swap operations affect 4-byte (or 2-word) groups of data. Therefore, you should use data swapping only when using an even number of words, such as when 32-bit integer or floating-point data.</p>
Node Address	1 to 255 (0 is a broadcast)	Specifies the node address of the Modbus slave device. <p>Note: Most Modbus devices only accept addresses in the range of 1 to 247, so check with the slave device manufacturer to see if a particular slave can use addresses 248 to 255.</p> <p>If you set the value to zero (0), the gateway broadcasts the command on the network. The Modbus protocol permits broadcast commands for <i>write</i> operations. Do not use node address 0 for <i>read</i> operations.</p>
Modbus Function	1, 2, 3, 4, 5, 6, 15, or 16	Specifies the Modbus Function Code executed by the command. These function codes are defined in the Modbus protocol. More information on the protocol is available from www.modbus.org (http://www.modbus.org) or see About the Modbus Protocol (page 108).) The following function codes are supported by the gateway. <p>1 - Read Coil Status</p> <p>2 - Read Input Status</p> <p>3 - Read Holding Registers</p> <p>4 - Read Input Registers</p> <p>5 - Force (Write) Single Coil</p> <p>6 - Preset (Write) Single Register</p> <p>15 - Force Multiple Coils</p> <p>16 - Preset Multiple Registers</p>

Parameter	Value	Description
MB Address in Device	Varies	<p>Specifies the starting Modbus register or bit address in the server for the command. Refer to the documentation of each Modbus server device for the register and bit address assignments valid for that device.</p> <p>The <i>Modbus Function</i> code determines whether the address is a register-level or bit-level OFFSET address into a given data type range. The offset is the target data address in the server minus the base address for that data type. Base addresses for the different data types are:</p> <ul style="list-style-type: none"> ▪ 00001 or 000001 (0x0001) for bit-level Coil data (Function Codes 1, 5, and 15). ▪ 10001 or 100001 (1x0001) for bit-level Input Status data (Function Code 2) ▪ 30001 or 300001 (3x0001) for Input Register data (Function Code 4) ▪ 40001 or 400001 (4x0001) for Holding Register data (Function Codes 3, 6, and 16). <p>Address calculation examples:</p> <ul style="list-style-type: none"> ▪ For bit-level Coil commands (FC 1, 5, or 15) to read or write a Coil 0X address 00001, specify a value of 0 (00001 - 00001 = 0). ▪ For Coil address 00115, specify 114 (00115 - 00001 = 114) ▪ For register read or write commands (FC 3, 6, or 16) 4X range, for 40001, specify a value of 0 (40001 - 40001 = 0). ▪ For 01101, 11101, 31101 or 41101, specify a value of 1100. (01101 - 00001 = 1100) (11101 - 10001 = 1100) (31101 - 30001 = 1100) (41101 - 40001 = 1100) <p>Note: If the documentation for a particular Modbus server device lists data addresses in hexadecimal (base16) notation, you must convert the hexadecimal value to a decimal value for this parameter. In such cases, you usually do not have to subtract 1 from the converted decimal number, as this addressing scheme typically uses the exact offset address expressed as a hexadecimal number.</p>

7.3 MBS Diagnostics

7.3.1 MBS PCB Diagnostics

The best way to troubleshoot the MBS driver is to use ProSoft Configuration Builder to access the diagnostic capabilities of the gateway through the Ethernet debug port. For instructions on how to access the diagnostics, see Diagnostics and Troubleshooting (page 27).

The following table summarizes the status information available in PCB for the MBS driver:

Connection Type	Submenu Item	Description
MBS Port [x]	Config	Configuration settings for MBS Port [x].
	Comm Status	Status information for MBS Port [x] commands. Displays a summary of all the errors resulting from MBS Port [x] commands.
	Slave Status	Current poll status of each slave device on MBS Port [x].
	Modbus Cmds	Configuration for the MBS Port [x] Modbus command list.
	Modbus Cmd Errors (Decimal)	Current error codes for each command on the MBS Port [x] command list in decimal number format. A zero means there is currently no error for the command.
	Modbus Cmd Errors (Hex)	Current error codes for each command on the MBS Port [x] command list in hexadecimal number format. A zero means there is currently no error for the command.

7.3.2 MBS Status Data in Upper Memory

Each Modbus port has an associated status data area located in the gateway's upper memory. The Data Map functionality of the gateway can be used to map this data into the normal user data range of the gateway's database. See Mapping Data in Module Memory (page 21).

General Modbus Error and Status Data

The following table lists the starting addresses in upper memory where the gateway writes general error and status data for each Modbus master or slave port. Note that all the status values are initialized to zero (0) at power-up, cold boot and during warm boot.

Modbus Port	Starting Address
1	4400
2*	4800
3*	5200
4*	5600

*Status data for Ports 2 through 4 is only present in 4-port PLX3x gateways.

Warning: None of these addresses are available in the Modbus address range. In order to access this data through a Modbus request, you must move the data into the 0 to 3999 address range. See Mapping Data in Module Memory (page 21).

Port 1 General Modbus Error and Status Layout

The addresses listed are for Port 1 only. The format is the same for each port. See General Modbus Error and Status Data (page 123) for the start address for each port.

Example Internal Database Address	Offset	Description
4400	0	Number of Command Requests
4401	1	Number of Command Responses
4402	2	Number of Command Errors
4403	3	Number of Requests
4404	4	Number of Responses
4405	5	Number of Errors Sent
4406	6	Number of Errors Received
4407	7	Configuration Error Code
4408	8	Current Error/Index
4409	9	Last Error/Index

Slave Port: General Port State and ComState Status

Note: There are two additional port status parameters that are not available from the General Modbus Error and Status Data area. The status values, Port *State* and Port *ComState* (circled in red in the graphic below), can be found only in the PCB diagnostic menus under Comm Status for a port.

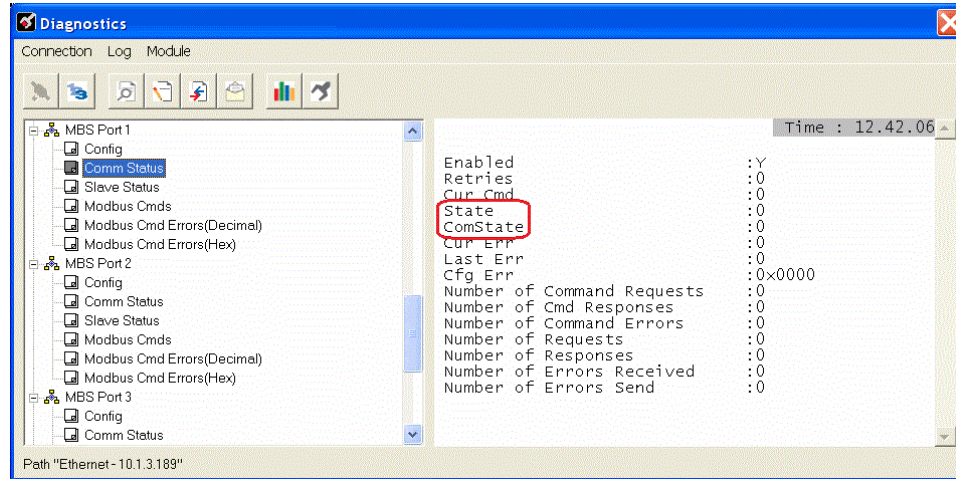

These status values are state registers. They are used as "scratchpad" areas by the gateway firmware to keep track of the current logical state of activities on a slave port. These state registers are constantly changing as the gateway progresses through the various stages needed to process communication on the serial ports. This processing happens faster than can be followed, unless a port error causes the value to remain constant for some noticeable length of time.

The diagnostic screen displays a snapshot of the data; that is, the current values at the time they are displayed, but the module does not update the data. They are not live-data screens. Therefore, to see a change in *State* or *ComState*, you must repeatedly update the screen by pressing the appropriate menu key to have the screen refreshed. Depending on the refresh timing you may or may not see a change in the displayed values every time you call for an update.

The *State* register may display any of the following values:

State Value	Description
-2	Preparing port, Flushing all buffers, Scan for RTS-Off, or Waiting for port enable signal
-1	Waiting for receipt of data
0	Undefined state
1	Receiving a message from the Master
2	Building a slave response message
7	Modbus master is fetching next command
2000	Sending slave response to the Master

The *ComState* register may display any of the following values:

ComState Value	Description
0	Port not sending data (Wait for send)
1	Setting up minimum Response Delay Timer
101	Waiting for Minimum Response Delay to timeout
2	Turning on RTS line and starting RTS-On Delay Timer
3	Waiting for RTS-On Delay timer to timeout
4	Sending data
5	Waiting for all data to be sent and starting RTS-Off Delay Timer
6	Waiting for RTS-Off Delay timeout and then turning OFF RTS line after timeout

Master Port: Command List Errors

The individual command errors for each master port are returned to the address locations specified in the following table. Each port can have up to 100 commands configured. Each configured command uses one word of these data areas to store a value representing the execution status from the most recent command execution attempt. Note that all the status values are initialized to zero (0) at power-up, cold boot and during warm boot.

Modbus Port	Address Range
1	4410 to 4509
2*	4810 to 4909
3*	5210 to 5309
4*	5610 to 5709

*Status data for Ports 2 through 4 is only present in 4-port PLX3x gateways

Warning: None of these addresses are available in the Modbus address range. In order to access this data through a Modbus request, you must move the data into the 0 to 3999 address range. See Mapping Data in Module Memory (page 21).

Port 1 Command Error List Layout

The first word in the specified register location contains the status/error code for the first command in the port's *Command List*. Successive words in the *Command Error List* are associated with corresponding commands in the list.

The addresses listed are for Port 1 only; but the format is the same for each port. See Master Port: Command List Errors (page 126) for the start address for each port.

Internal Database Address (Example)	Offset	Description
4410	0	Command #1 Error Code
4411	1	Command #2 Error Code
4412	2	Command #3 Error Code
4413	3	Command #4 Error Code
4414	4	Command #5 Error Code
...
...
...
4507	97	Command #98 Error Code
4508	98	Command #99 Error Code
4509	99	Command #100 Error Code

Note that the gateway initializes the Command Error List tables to zero (0) at power-up, cold boot, and warm boot. If a command executes successfully, the value in the associated register remains at zero (0), indicating no command error was detected. Any non-zero value in this table indicates the corresponding command experienced an error.

The data in this table is dynamic and is updated each time a command is executed. Therefore, if the command fails once and succeeds on the next attempt, the error code from the previously failed attempt is overwritten with zero and be lost. Error codes are not archived in the gateway's database. To see if the port has experienced an error since the most recent restart and what the most recently occurring error was, if any, you can check the *Last Error/Index*.

Master Port: Modbus Slave List Status

The gateway stores *Slave List Status* values for each Master port in the address locations specified in the following table. Note that all the status values are initialized to zero (0) at power-up, cold boot and during warm boot.

Modbus Port	Address Range
1	4510 to 4764
2*	4910 to 5164
3*	5310 to 5564
4*	5710 to 5964

*Status data for Ports 2 through 4 is only present in 4-port MBS gateways.

Warning: None of these addresses are available in the Modbus address range. In order to access this data through a Modbus request, you must move the data into the 0 to 3999 address range. See Mapping Data in Module Memory (page 21).

Port 1 Slave List Status Layout

The addresses listed are for Port 1 only; but the format is the same for each port. See Master Port: Modbus Slave List Status (page 128) for the start address for each port.

Internal Database Address (Example)	Offset	Description
4510	0	Slave #1 Status
4511	1	Slave #2 Status
4512	2	Slave #3 Status
4513	3	Slave #4 Status
4514	4	Slave #5 Status
	.	.
	.	.

The slave status list contains the current poll status of each slave device on a master port. Slaves attached to a master port can have one of three states.

Status	Description
0	The slave has is not defined in the command list for the master port and is not polled from the Command List.
1	The slave is configured to be polled by the master port and the most recent communication attempt was successful.
2	The Master port failed to communicate with the slave device. Communication with the slave is suspended for a user-defined period based on the scanning of the command list.

Slaves are defined to the system when the gateway loads the *Master Command List* during start-up and initialization. Each slave defined is set to a state value of 1 in this initial step. If the master port fails to communicate with a slave device (timeout expired on a command, retries failed), the master sets the state of the slave to a value of 2 in this status table. This suspends communication with the slave device for a user-specified *Error Delay Count*.

When the master first suspends polling of a particular slave, it creates an *Error Delay Counter* for this slave address and set the value in that counter equal to the *Error Delay Counter* parameter in the configuration file. Then, each time the gateway scans a command in the list that has the address of a suspended slave, the gateway decrements the delay counter value. When the value reaches zero, the gateway sets the slave state to 1. This re-enables polling of the slave.

The first word in the defined register locations contains the status code for slave node address 1. Each successive word in the list is associated with the next node in sequence, up to slave node address 247.

7.3.3 MBS Error Codes

These are error codes that are part of the Modbus protocol or are extended codes unique to this gateway.

Standard Modbus Exception Code Errors

These error codes are generated or returned on both the Controller and slave ports. These codes are the standard Modbus errors.

Code	Description
1	Illegal Function
2	Illegal Data Address
3	Illegal Data Value
4	Failure in Associated Device
5	Acknowledge
6	Busy, Rejected Message

Gateway Communication Error Codes

These gateway-specific error codes are also returned from the command polling process and stored in the *Command Error List* memory area.

Code	Description
-1	CTS modem control line not set before transmit
-2	Timeout while transmitting message
-11	Timeout waiting for response after request
253	Incorrect slave address in response
254	Incorrect function code in response
255	Invalid CRC/LRC value in response

MBS Command List Error Codes

These command-specific error codes are detected during command list loading at gateway reboot and are stored in the *Command Error List* memory area.

Code	Description
-41	Invalid enable code
-42	Internal address > maximum address
-43	Invalid node address (<0 or > 255)
-44	Count parameter set to 0
-45	Invalid function code
-46	All parameters set to 0
-47	All parameters set to -1

7.4 MBS Reference

For the Modbus Protocol Specifications, see About the Modbus Protocol (page 108).

8 ASCII Protocol

In This Chapter

- ❖ ASCII Functional Overview..... 131
- ❖ ASCII Configuration..... 138
- ❖ ASCII Diagnostics 143

8.1 ASCII Functional Overview

You can use the ASCII protocol in the PLX3x gateway to interface many different protocols into the Rockwell Automation family of processors, or other software-based solutions. The ASCII driver permits the gateway to interface any ASCII device to the many protocols and networks available. ASCII devices include barcode scanners, weigh scales, many field instruments, printers, and terminals. The driver supports one to four ports that provide accessibility from one to four independent serial networks. The number of ports depends on your specific gateway model.

The following illustration shows the functionality of the ASCII protocol:

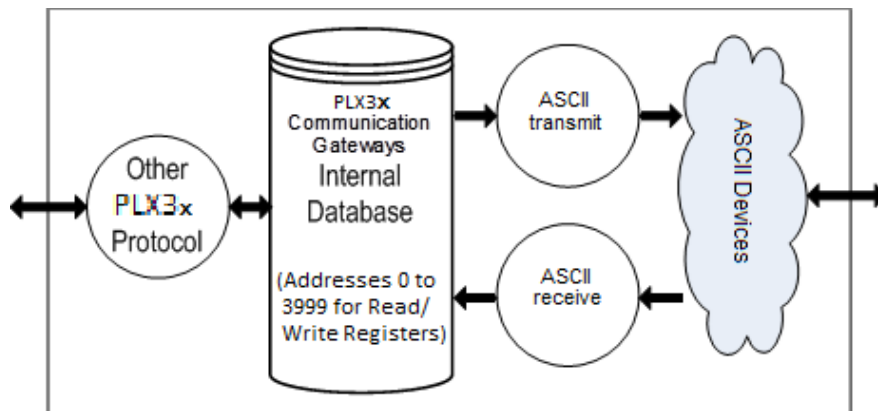

8.1.1 General Specifications

Ports	One to four ports to receive and/or transmit data
Receive buffer size	255 bytes
Receive termination	Stream mode, termination character(s), message timeout, inter-character delay, or packet size length
Receive database location	-1 = Disable receiver, 0 to 3896
Transmit buffer size	255 bytes
Transmit characters with pacing	0 to 65535 millisecond delay between each transmitted character
Transmit database location	-1 = Disable transmitter, 0 to 3896
Communication Configuration	Baud Rate: 110 to 115,200 Parity: None, Odd, Even Data Bits: 5 to 8 Stop Bits: 1 or 2 RTS On and Off Timing: 0 to 65535 milliseconds Minimum Response Delay: 0 to 65535 milliseconds Hardware or Software Handshaking: RTS/CTS, DTR/DSR, or XON/XOFF

8.1.2 ASCII Data Flow

The following illustration shows receive and transmit data flow of the ASCII driver.

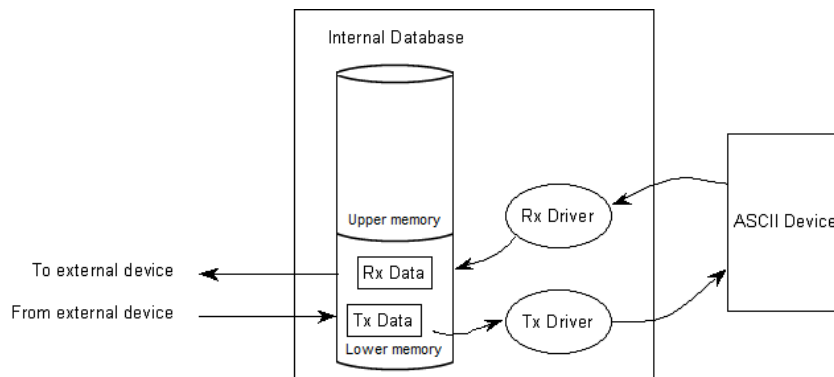

Data received from the ASCII device is accepted by the receive driver and placed in the receive database location configured by the user. The receive driver waits until the termination condition that you define is recognized while receiving the data before placing the new data into the database.

For example, if you use the carriage-return character (ASCII 13) as the termination condition for a received message, this signals the end of the message. When the receive driver sees this character in the input stream, it takes all received characters and places them in the internal database.

In both receive and transmit operations, the driver requires a signal to determine when new data is received or must be transmitted. The first word in the two data area is used for this purpose. When the value of the first word changes, new data is available.

Here is a receive example.

- 1 The sequence number in the receive data block has a value of 0 (set when the module initializes).
- 2 The ASCII device sends a new data packet and the termination condition is present.
- 3 The receive driver copies the data into the internal data area, sets the message length in the data area, and finally, sets the new sequence number.

Receive Data

The gateway places data from the receive driver in the module's internal database in a fixed format at the location that you define in ProSoft Configuration Builder (PCB). The receiver driver is disabled if you set the receive database start location to a value of -1 when you configure the gateway in PCB. The following table shows the structure of the received data.

Word Offset	Description
0	Receive sequence number. This register is incremented by the Module's Receive Driver for each new packet received.
1	Number of characters transmitted (0 to 255) from last transmit request.
2	Number of characters (0 to 256) in receive block (3 to 130).
3 to 130	Received data on port.

- The first word of the data block signals that new receive data is available.
- Word 1 of the block contains the number of bytes in the last message transmitted on the port.
- Word 2 contains the number of bytes in the received message data area.
- Words 3 to 130 contain the data received.

Swapping data bytes

If you configure the module to swap the data bytes, the receive driver swaps the bytes in each word before placing the data into the data block. Because the data received may contain an odd number of bytes, the driver increases the length of the message by 1 when the data has an odd number of bytes when using the the swap option. This avoids losing the last byte of data in the message.

Transmit Data

Data to transmit by the transmit driver is placed in the module's internal database in a fixed format at the location that you define in ProSoft Configuration Builder (PCB). The transmit driver is disabled if you set the database start location to a value of -1. The following table shows the structure of transmit data.

Word Offset	Description
0	Transmit sequence number. This number is incremented by the user's application for each new packet to transmit.
1	Number of characters received (0 to 256) from last receive request.
2	Inter-character delay for this message (milliseconds between characters)
3	Number of characters to transmit on Port (0 to 255)
4 to 131	Data to transmit on port

- The first word of the data block signals when new transmit data is available.
- Word 1 of the block optionally contains the number of characters processed in the last receive message.
- Word 2 of the message paces the characters during the transmission process. This may be required when interfacing with slow ASCII devices (for example, modems in command mode). If the word is set to a value other than zero, the driver inserts a time delay corresponding to the number of milliseconds between each character transmitted. If you set word 2 to zero, the transmit driver sends the whole data packet as fast as the driver can function.
- Word 3 of the data block contains the number of bytes present in the transmit data area to send out the ASCII port.
- Words 4 to 131 contain the data to transmit.

Swapping data bytes

If you configure the gateway to swap the data bytes, the transmit driver swaps each byte in the words received before transmitting them. Take care if an odd number of bytes are sent by the end device when using the swap option. The last byte of the message may be lost.

8.1.3 ASCII Internal Database

The internal database is central to the functionality of the PLX3x gateway. The gateway shares this database between all the communications ports on the gateway and uses it as a conduit to pass information from one protocol to another device on one network to one or more devices on another network. This permits data from devices on one communication port to be accessed and controlled by devices on another communication port.

In addition to data from the client and server, you can map status and error information generated by the gateway into the user data area of the internal database. The internal database is divided into two areas:

- Upper memory for the module status data area. This is where the module writes internal status data for the protocols supported by the module.
- Lower memory for the user data area: Module memory 0 to 3999. This is where incoming data from external devices is stored and accessed.

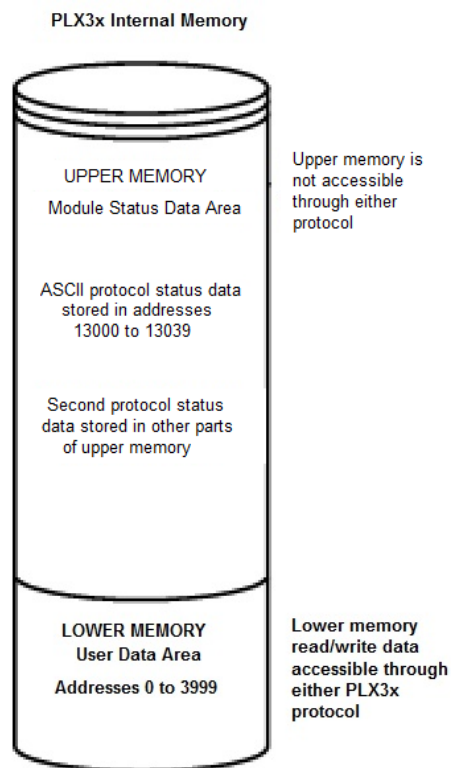

Data can be written to and read from the user data area.

- To use the transmit function in the module, you define the starting location in the user data area for the transmitted data.
- To use the receive function in the module, you define the starting location in the user data area for the received data.

Note: If you want to access module status data in the upper memory, you can use the data mapping feature in the gateway to copy data from the module status data area to the user data area. See Mapping Data in Module Memory (page 21). Otherwise, you can use the diagnostic functions in ProSoft Configuration Builder to view module status data. For more information on the module status data, see ASCII Diagnostics (page 143).

8.1.4 ASCII Modes of Operation

The PLX3x gateway can operate in several different modes with each port acting independently. The configuration of each port's driver determines its mode. The following topics describe these modes and describe the flow of data between the pieces of hardware (the ASCII device and the gateway). These topics describe the three possible types of communication devices that can be attached to application ports: receive-only, transmit-only, and transmit-receive mode. See ASCII Configuration (page 138) for the specific configuration information for each mode.

Receive-Only Mode

A port on the module configured to function in receive-only mode only receives data from an ASCII device. In this mode, the gateway never transmits data back to the ASCII device. Any data received from the ASCII device is passed from the receiver driver (Rx Driver) to the gateway's internal database (Rx Data). The following illustration shows the flow of data on a port configured for receive-only mode.

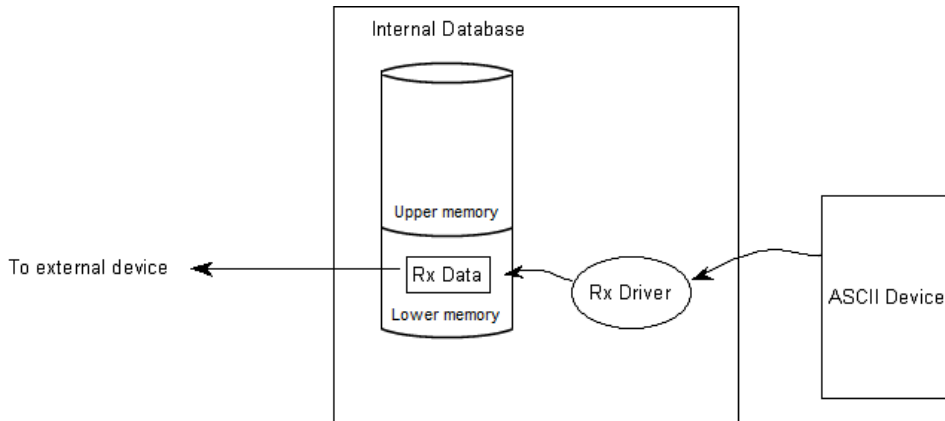

Transmit-Only Mode

A port on the module configured to function in transmit-only mode only transmits data from the gateway’s internal database (received from an external source or mapped from upper memory) to an ASCII device. When the transmit driver (Tx Driver) recognizes a new write block containing data in the module’s internal database, it transmits this data out to the port. The sequence number in the block is different that that of the previous block. This signals that the packet is fully assembled and ready to send. The following illustration shows flow of data on a port configured for transmit-only mode.

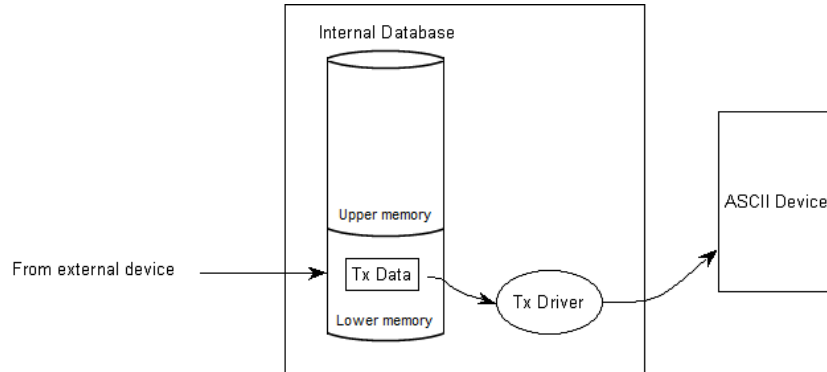

Transmit-Receive Mode

A port configured in transmit-receive mode can send and receive data from an ASCII device (for example, a terminal). This mode functions in both the transmit and receive modes. Data flow to and from an ASCII device is handled by the module’s transmit and receive drivers.

- Data received from the ASCII device is stored in the module’s internal database until ready to be sent to an external device.
- Data received by an external device is also stored in the module’s internal database until ready to be transmitted to the ASCII device.

The following illustration shows the flow of data on a port configured for transmit-receive mode.

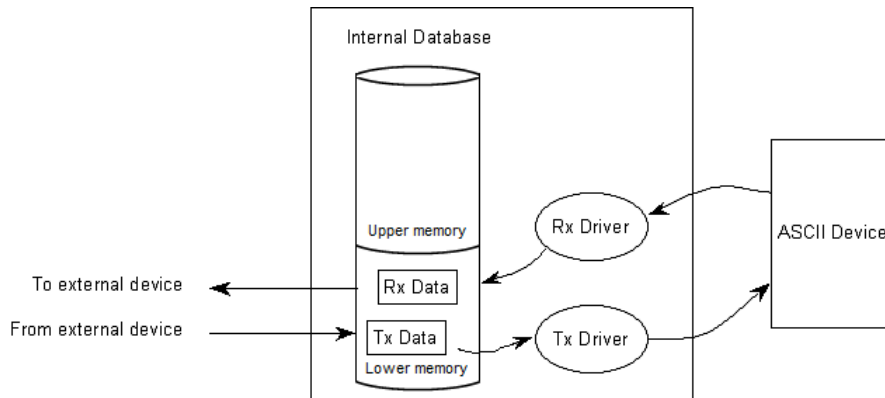

8.2 ASCII Configuration

The ASCII driver requires that a minimum amount of configuration data must be transferred to the PLX3x gateway from the gateway's file system. Take care when configuring the module parameters. If the module does not function as expected, examine the configuration file using the Debugger Port on the module. All configuration parameters for the driver are found under the [ASCII Port x] section. The x in the section name will have a value of 0 to 3 corresponding to the appropriate ASCII port. See Diagnostics and Troubleshooting (page 27).

After you set up the configuration file, download it to the module using ProSoft Configuration Builder.

8.2.1 ASCII Port [x]

Use the *ASCII Port [x]* section in ProSoft Configuration Builder to configure the ASCII port parameters. The value of [x] depends on the number of ports on your PLX3x gateway (1 to 4).

To configure the ASCII Port in PCB

- 1 In ProSoft Configuration Builder, click the **[+]** next to the gateway, then click the **[+]** next to *ASCII Port [x]*.

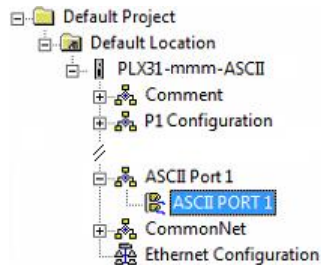

- 2 Double-click the second *ASCII PORT [x]* to display the *Edit - ASCII PORT [x]* dialog box.
- 3 In the dialog box, click a parameter and then enter a value for the parameter.

Parameter	Value	Description
Enabled	Yes or No	Specifies if the port on the module will be utilized. <ul style="list-style-type: none"> ▪ No - the port will not be used. ▪ Yes - the port will be used supporting the ASCII protocol.
RS Interface	0, 1, 2	Specifies the RS interface to be utilized when serial ports are used on the serial expansion module (Ports 1 to 3). 0 = RS-232 1 = RS-485 2 = RS-422
Rx DB Start	-1 or 0 to 3896	Specifies the starting location in the internal database where the received data will be stored. The buffer holds 130 words, however, the first three words of the data area define the sequence number, last write byte count

		and the Rx message length. If the parameter is set to -1, the port will not receive data. See Receive Data (page 133) for detailed information on Rx data structure.																										
Tx DB Start	-1 or 0 to 3896	Specifies the starting location in the internal database where the transmit data will be stored. The buffer holds 130 words, however, the first three words of the data area define the sequence number, last write byte count and the Rx message length. If the parameter is set to -1, the port will not transmit data. See Transmit Data (page 134) for detailed information on Tx data structure.																										
Baud Rate		<p>Specifies the bits per second rate to use on the port. Enter the baud rate (bits per second or bps) as a value. You may omit any trailing zeros from the entered value for the higher bps rates and the gateway firmware will interpret the setting correctly. For example:</p> <p>To select 19200 bps, you may enter 192 or 19200.</p> <table border="0"> <thead> <tr> <th>Valid Values</th> <th>Bits per Second (bps)</th> </tr> </thead> <tbody> <tr><td>110</td><td>110 bps</td></tr> <tr><td>150</td><td>150 bps</td></tr> <tr><td>300</td><td>3000 bps</td></tr> <tr><td>600</td><td>6000 bps</td></tr> <tr><td>1200</td><td>1200 bps</td></tr> <tr><td>2400</td><td>2400 bps</td></tr> <tr><td>4800</td><td>4800 bps</td></tr> <tr><td>96 or 9600</td><td>9600 bps</td></tr> <tr><td>192 or 19200</td><td>19200 bps</td></tr> <tr><td>384 or 38400</td><td>38400 bps</td></tr> <tr><td>576 or 57600</td><td>57600 bps</td></tr> <tr><td>115 or 115200</td><td>115200 bps</td></tr> </tbody> </table>	Valid Values	Bits per Second (bps)	110	110 bps	150	150 bps	300	3000 bps	600	6000 bps	1200	1200 bps	2400	2400 bps	4800	4800 bps	96 or 9600	9600 bps	192 or 19200	19200 bps	384 or 38400	38400 bps	576 or 57600	57600 bps	115 or 115200	115200 bps
Valid Values	Bits per Second (bps)																											
110	110 bps																											
150	150 bps																											
300	3000 bps																											
600	6000 bps																											
1200	1200 bps																											
2400	2400 bps																											
4800	4800 bps																											
96 or 9600	9600 bps																											
192 or 19200	19200 bps																											
384 or 38400	38400 bps																											
576 or 57600	57600 bps																											
115 or 115200	115200 bps																											
Parity	None, Odd, Even	Specifies the type of parity checking to use. Parity is a simple error checking algorithm used in serial communication. All devices communicating through this port must use the same parity setting.																										
Data Bits	5, 6, 7 or 8	Specifies the number of data bits for each word used by the protocol. All devices communicating through this port must use the same number of data bits.																										
Stop Bits	1 or 2	Specifies the number of stop bits. Stop bits signal the end of a character in the data stream. For most applications, use one stop bit. For slower devices that require more time to re-synchronize, use two stop bits. All devices communicating through this port must use the same number of stop bits.																										
RTS On	0 to 65535 milliseconds	Specifies the number of milliseconds to delay after Ready To Send (RTS) is asserted before data will be transmitted.																										
RTS Off	0 to 65535 milliseconds	Specifies the number of milliseconds to delay after the last byte of data is sent before the RTS modem signal will be set low.																										
Handshaking	N, Y, D, X	<p>Specifies the handshaking used on the port.</p> <ul style="list-style-type: none"> ▪ N - No hardware or software handshaking ▪ Y - RTS/CTS hardware handshaking ▪ D - DTR/DSR hardware handshaking ▪ X - XON/XOFF software handshaking. 																										

Rx Termination Type	0 to 15	Specifies the receive termination characteristics for the port. This value is bit mapped as follows: <ul style="list-style-type: none"> ▪ Bit 0 - Termination character(s) used ▪ Bit1- Message timeout used ▪ Bit2 - Intercharacter delay timeout used ▪ Bit3 - Packet size limit used. If the parameter is set to zero, the port is placed in stream mode.
Rx Term Count	0 to 12	Specifies the number of termination characters used to define the end of received message if bit 0 of the Type parameter is set.
Rx Term Chars	ASCII characters	This array of 12 characters specifies the termination characters at the end of each received message. Each character occupies one position in the array. The number of characters to be used in the array is set in the Rx Term Count parameter.
Rx Packet Length	0 to 200	Specifies the length of data required to be received on the port before transferring the data to the processor if bit 3 is set in the RX Termination Type parameter.
Rx Timeout	0 to 65535	Specifies the number of milliseconds to wait after the first character is received on the port before automatically sending the data to the processor if bit 1 is set in the RX Termination Type parameter.
Rx Delay	0 to 65535	Specifies the number of milliseconds to wait between each character received on the port before sending the data to the processor if bit 2 is set in the RX Termination Type parameter.
Swap Rx Data Byte	Yes or No	Specifies if the data received by the module has the byte order of the data swapped. <ul style="list-style-type: none"> ▪ No - no byte swapping occurs. ▪ Yes - the odd byte is swapped with the even byte in each word of data received.
Tx Timeout	0 to 65535	Specifies the timeout period to transmit a message out the port. A message must be transmitted out the port within the specified timeout period. Message transmission is aborted if the timeout is exceeded.
Tx Minimum Delay	0 to 65535	Specifies the minimum number of milliseconds to delay before transmitting a message out the port. This pre-send delay is applied before the RTS on time. This may be required when communicating with slow devices.
Swap Tx Data Bytes	Yes or No	Specifies if the data to be transmitted by the module has the byte order of the data swapped. <ul style="list-style-type: none"> ▪ No - no byte swapping occurs. ▪ Yes - the odd byte is swapped with the even byte in each word of data received.

8.2.2 Configuring the Port for Receive-Only Mode

In order to set a port for Receive-Only mode, ensure that the *Rx DB Start* parameter in the configuration file contains the starting location where the data will be stored. The *Tx DB Start* parameter must contain a value of **-1**. This value indicates that the port will not transmit any data.

8.2.3 Configuring a Port for Transmit-Only Mode

In order to set a port for Transmit-Only mode, ensure that the *Tx DB Start* parameter in the configuration file contains the starting location where the data will be stored. The *Rx DB Start* parameter must contain a value of **-1**. This value indicates that the port will not receive any data.

8.2.4 Configuring a Port for Transmit-Receive Mode

In order to set a port to both receive data and transmit data to an ASCII device, ensure that the *Rx DB Start* parameter and the *Tx DB Start* parameter both contain values that specify data storage starting locations for received and transmitted data. A value of **-1** in either parameter disables the particular function that the parameter serves.

8.2.5 Termination of Received Data

When the PLX3x gateway receives data on the application port, you must define when this data will be transferred to the internal database in the module. You do this by setting the termination type for the port. When the termination condition is met, the gateway sends the data from the port's receive buffer (data area of 255 bytes) to the internal database. You set the termination type in the bit mapped Rx Termination Type field of the module object. The following illustration shows the bit map used for this parameter.

Termination Type Field

Bit(s)	4 to 7	3	2	1	0
Bit Value	-	8	4	2	1
Definition	Reserved	Packet size limit used	Intercharacter delay timeout used	Message timeout used	Termination character(s) used

If none of the bits are set (Type=0), the port is configured for stream mode. Any characters received on the port are immediately sent to the processor. The processor must buffer and assemble a packet of information if this mode is selected as required by the application. If the data can be handled by the processor in this mode and it is appropriate for your application, this is the fastest method of communication between the device and the processor.

Any combination of bits is acceptable to the module and should be set to match the device on the specific port. An example of each termination type appears below.

Termination character(s) used

Settings:
 Count = 1 (RTermCnt=1)
 Termination on 0x0d (carriage return character) (RTermChar = 0d 00 00 00 ...)

Data Received on port:

A B C 0x0d D E

Comment:
 The characters "ABC" will be sent along with the 0x0d character to the controller after the 0x0d character is received. The characters "DE" will not be sent until the 0x0d character is received.

Message timeout used

Settings:
 Message timeout = 1000 mSec (Rtimeout=1000)

Data Received on port:

Comment:
 After the 'A' character is received on the port, the message timeout is started. The characters "ABCDE" will be sent to the controller in one block. The characters "FG" will follow in the second block one second later.

Intercharacter delay timeout used

Settings:
 Intercharacter delay timeout = 300 mSec (Rdelay=300)

Data Received on port:

Comment:
 After each character is received, the intercharacter delay timer is reset. The characters "ABCDEF" will be sent to the controller in one block because the delay timer expires. The characters "GH" will follow in the second block when the next time gap is recognized.

Packet size limit used**Settings:**

Packet size = 4 (RPacketLen=4)

Data Received on port:

A B C D E F G H I J

Comment:

The first block sent to the controller will contain the characters "ABCD", and the second block will contain the characters "EFGH". The characters "IJ" will not be sent until two more characters are received on the port.

8.3 ASCII Diagnostics

8.3.1 ASCII PCB Diagnostics

The best way to troubleshoot the ASCII driver is to use ProSoft Configuration Builder to access the diagnostic capabilities of the gateway through the Ethernet debug port. For instructions on how to access the diagnostics, see *Diagnostics and Troubleshooting* (page 27).

The following table summarizes the status information available in PCB for the ASCII driver.

Connection Type	Submenu Item	Description
ASCII Port [x]	Config	Configuration settings for the ASCII port.
	Comm Status	Status of the ASCII communications. Displays any configuration errors, as well as the communication statistics.

8.3.2 ASCII Status Data in Upper Memory

Each ASCII port associated with the ASCII driver has an associated status data area. This data is in the upper memory of the module, and cannot be accessed directly. You must use the Data Map function in the module to map this data into the lower memory (user data area) of the module's database. See Mapping Data in Module Memory (page 21).

The following tables lists the content of the status data areas associated with each ASCII port driver.

ASCII Port Driver Status

Port 0 Status Data

Status Register	Description
13000	Receive State: -1 = Listening for data 1 = Receiving Port Data 2 = Waiting for Backplane transfer
13001	Receive character count
13002	Receive message count
13003	Transmit State: 0 = Waiting for Data to Send 1 = RTS On 2 = RTS Timeout 3 = Sending data 4 = Waiting for RTS Off 5 = RTS turned off 30 = Intercharacter Delay 31 = Intercharacter Delay 32 = Intercharacter Delay 100 = Message Delay before Transmit 101 = Message Delay before Transmit
13004	Transmit character count
13005	Transmit message count
13006	Configuration error word
13007 to 13009	No Valid Data

Port 1 Status Data

Status Register	Description
13010	Receive State: -1 = Listening for data 1 = Receiving Port Data 2 = Waiting for Backplane transfer
13011	Receive character count
13012	Receive message count
13013	Transmit State: 0 = Waiting for Data to Send 1 = RTS On 2 = RTS Timeout 3 = Sending data 4 = Waiting for RTS Off 5 = RTS turned off 30 = Intercharacter Delay 31 = Intercharacter Delay 32 = Intercharacter Delay 100 = Message Delay before Transmit 101 = Message Delay before Transmit
13014	Transmit character count
13015	Transmit message count
13016	Configuration error word
13017 to 13019	No Valid Data

Port 2 Status Data

Status Register	Description
13020	Receive State: -1 = Listening for data 1 = Receiving Port Data 2 = Waiting for Backplane transfer
13021	Receive character count
13022	Receive message count
13023	Transmit State: 0 = Waiting for Data to Send 1 = RTS On 2 = RTS Timeout 3 = Sending data 4 = Waiting for RTS Off 5 = RTS turned off 30 = Intercharacter Delay 31 = Intercharacter Delay 32 = Intercharacter Delay 100 = Message Delay before Transmit 101 = Message Delay before Transmit
13024	Transmit character count
13025	Transmit message count
13026	Configuration error word
13027 to 13029	No Valid Data

Port 3 Status Data

Status Register	Description
13030	Receive State: -1 = Listening for data 1 = Receiving Port Data 2 = Waiting for Backplane transfer
13031	Receive character count
13032	Receive message count
13033	Transmit State: 0 = Waiting for Data to Send 1 = RTS On 2 = RTS Timeout 3 = Sending data 4 = Waiting for RTS Off 5 = RTS turned off 30 = Intercharacter Delay 31 = Intercharacter Delay 32 = Intercharacter Delay 100 = Message Delay before Transmit 101 = Message Delay before Transmit
13034	Transmit character count
13035	Transmit message count
13036	Configuration error word
13037 to 13039	No Valid Data

ASCII Error Codes

If the module is configured correctly, the configuration error word should have a value of zero. Any other value indicates a configuration error. Use the value in the configuration error word to determine which set of parameters are invalid in the driver configuration area. The following table lists the bits associated with each configuration error in the error word:

Bit	Code	Description
0	0x0001	Invalid selection for enabled parameter
1	0x0002	Invalid Rx DB Start parameter
2	0x0004	Invalid Tx DB Start parameter
3	0x0008	Invalid Baud Rate
4	0x0010	Invalid Parity (N, O, E, M or S)
5	0x0020	Invalid Data bits (5 to 8)
6	0x0040	Invalid Stop bits (1 or 2)
7	0x0080	Invalid Handshaking parameter (N, Y, D or X)
8	0x0100	Invalid Rx Termination Type
9	0x0200	Invalid Rx Term Count value
10	0x0400	Invalid Rx Timeout
11	0x0800	Invalid Rx Delay
12	0x1000	Invalid Rx Packet Length
13	0x2000	Invalid Tx Timeout
14	0x4000	Invalid RS interface selected (0 to 2)
15	0x8000	

9 SIE Protocol

In This Chapter

- ❖ SIE Functional Overview 149
- ❖ SIE Configuration 153
- ❖ SIE Diagnostics 166
- ❖ SIE Reference 170

9.1 SIE Functional Overview

You can use the PLX3x Siemens Industrial Ethernet (SIE) protocol to easily interface with multiple Siemens Industrial Ethernet server-compatible instruments and devices. The SIE protocol improves performance when controlling multiple servers on a Siemens Industrial Ethernet network by supporting up to 20 clients. The gateway's clients interface with processors (and other server-based devices) on the SIE network using a user-constructed command list of up to 16 entries per client. The gateway's internal database is the source for write commands to the remote processors. The gateway stores data collected from the processors using read commands in the gateway's database. The following illustration shows the functionality of the SIE protocol.

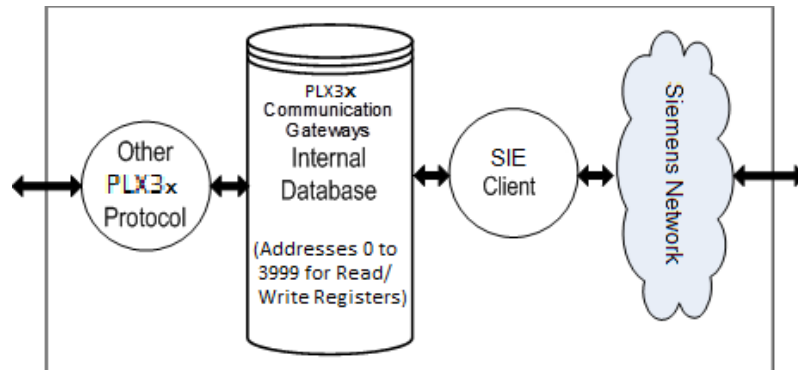

9.1.1 SIE General Specifications

10/100 MB Ethernet Communication port	<ul style="list-style-type: none"> ▪ Actively reads data from and writes data to Siemens Industrial Ethernet devices, using Siemens Industrial Ethernet protocol ▪ Siemens Industrial Ethernet data types overlap in the gateway's memory database, so the same data can be conveniently read or written as bit-level or register-level data ▪ Offers 20 client connections with up to 16 commands each to multiple servers ▪ Configurable floating-point data movement ▪ Status and error information is generated by the gateway
Supported PLC Data Exchange (Read and Write)	Siemens S7-200, Siemens S7-300, Siemens S7-400, Siemens S7-1200
Supported Register Types	DB, Inputs, Outputs, Flags, Counters, Timers

9.1.2 SIE Gateway Internal Database

The internal database is central to the functionality of the PLX3x gateway. The gateway shares this database between all the communications ports on the gateway and uses it as a conduit to pass information from one protocol to another device on one network to one or more devices on another network. This permits data from devices on one communication port to be accessed and controlled by devices on another communication port.

In addition to data from the client and server, you can map status and error information generated by the gateway into the user data area of the internal database. The internal database is divided into two areas:

- Upper memory for the module status data area. This is where the module writes internal status data for the protocols supported by the module.
- Lower memory for the user data area. This is where incoming data from external devices is stored and accessed.

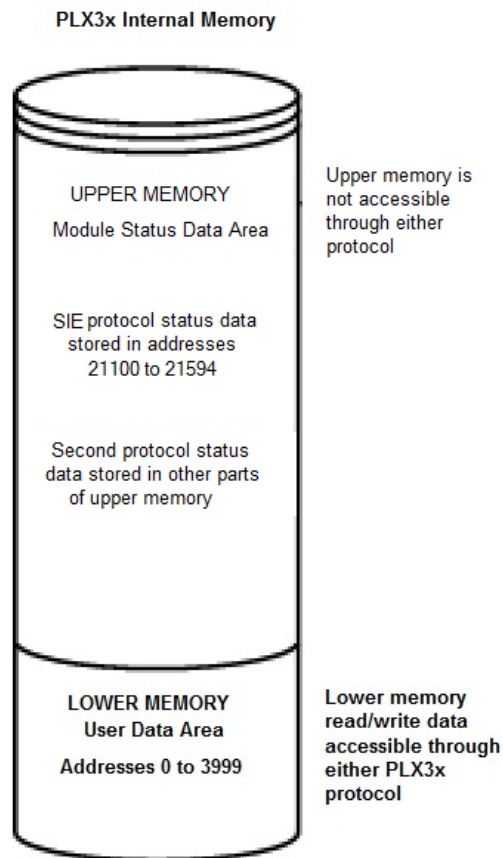

Either protocol in the PLX3x gateway can write data to and read data from the user data area.

- If the module is acting as a client/master, you create commands to read data from external client/server devices and store the data in a specific location in the user data area.
- If the module is acting as a server/slave, the external client/master devices write data to a specific location in the user data area.

Note: If you want to access module status data in the upper memory, you can use the data mapping feature in the gateway to copy data from the module status data area to the user data area. See Mapping Data in Module Memory (page 21). Otherwise, you can use the diagnostic functions in ProSoft Configuration Builder to view module status data. For more information on the module status data, see SIE Diagnostics (page 166).

SIE Client Access to Database

The client functionality exchanges data between the PLX3x gateway's internal database and data tables established in one or more processors or other server based devices. The command list that you define in ProSoft Configuration Builder specifies what data is to be transferred between the gateway and each of the servers on the network. No ladder logic is required in the processor (server) for client functionality, except to assure that sufficient data memory exists.

The following illustration describes the flow of data between the clients and the internal database.

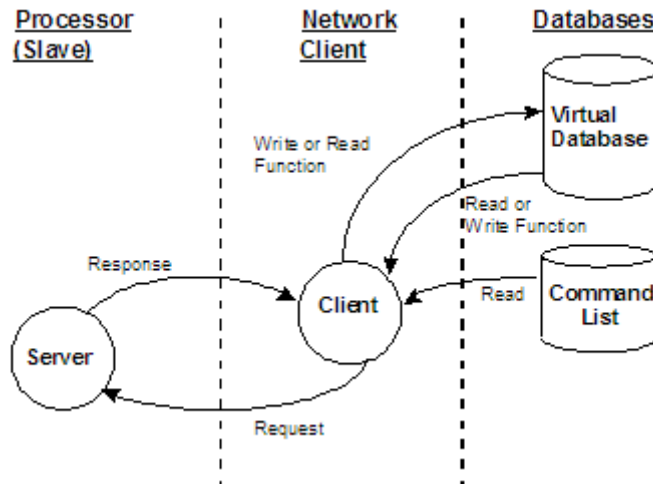

9.2 SIE Configuration

9.2.1 Configuring SIE Client [x] Connection

Use the *SIE Client [x]* section in ProSoft Configuration Builder to configure the SIE Client [x] parameters. The value of [x] depends on the number of ports on your PLX3x gateway (1 to 4).

To configure the ASCII Port in PCB

- 1 In ProSoft Configuration Builder, click the **[+]** next to the gateway, then click the **[+]** next to *SIE Client [x]*.

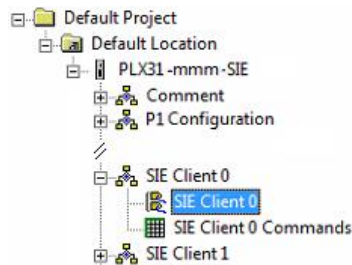

- 2 Double-click the second *SIE Client [x]* to display the *Edit - SIE Client [x]* dialog box.
- 3 In the dialog box, click a parameter and then enter a value for the parameter. The following table defines the configuration parameters for the SIE client (master):

Parameter	Value	Description
Minimum Command Delay	0 to 65535	Specifies the number of milliseconds to wait between the initial issuances of a command. This parameter can be used to delay all commands sent to servers to avoid "flooding" commands on the network. This parameter does not affect retries of a command as they will be issued when failure is recognized.
Response Timeout	0 to 65535	Specifies the time in milliseconds that a Client will wait before re-transmitting a command if no response is received from the addressed server. The value to use depends on the type of communication network used, and the expected response time of the slowest device on the network.
Retry Count	0 to 65535	Specifies the number of times a command will be retried if it fails.

9.2.2 Configuring SIE Client x Commands

The *SIE Client x Commands* section in *ProSoft Configuration Builder* sets the Siemens Industrial Ethernet Client Command list. This command list polls Siemens Industrial Ethernet server devices attached to the Siemens Industrial Ethernet client port. The PLX3x gateway supports many commands so that the gateway can communicate with a wide variety of Siemens Industrial Ethernet protocol devices.

The function codes for each command are those specified in the Siemens Industrial protocol. Each command list record has the same format.

- The first part of the record contains the information relating to the gateway.
- The second part contains information required to interface to the Siemens Industrial Ethernet server device.

Command List Overview

You must construct a command list to interface the gateway with Siemens Industrial Ethernet server devices. The commands in the list specify the server device to be addressed, the function to be performed (read or write), the data area in the device to interface with, and the registers in the internal database to be associated with the device data. Each client command list supports up to 16 commands.

The gateway processes the command list from top (command #1) to bottom. The *Poll Interval* parameter specifies a minimum delay time in tenths of a second between issuing commands.

To add SIE Client [x] commands

- 1 In ProSoft Configuration Builder, click the **[+]** next to the gateway, then click the **[+]** next to *SIE Client [x]*.

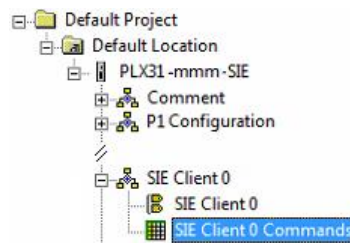

- 2 Double-click *SIE Client [x] Commands* to display the *Edit - SIE Client [x] Commands* dialog box.
- 3 Click **ADD ROW** to add a new command.
- 4 Click **EDIT ROW** or double-click the row to display the *Edit* dialog box where you configure the command.

Parameter	Value	Description
Enable	Disabled Enabled Conditional Write	Specifies if the command is to be executed and under what conditions. DISABLED (0) - The command is not executed in the normal polling sequence. ENABLED (1) - The command is executed upon each scan of the Command List if you set the <i>Poll Interval</i> to zero (0). If you set the <i>Poll Interval</i> to a non-zero value, the command is executed when the interval timer for that command expires. CONDITIONAL WRITE (2) - The command execute only if the internal data associated with the command changes.
Internal Address	0 to 3999 (for register-level addressing) or 0 to 63999(for bit-level addressing)	Specifies the database address in the gateway's internal database to use as the destination for data from a read command, or as the source for data for a write command. The gateway interprets the database address as a bit address or a 16-bit register (word) address, depending on the Siemens Industrial Ethernet's <i>Data Type</i> used in the command. <ul style="list-style-type: none"> ▪ If you use <i>Data Type = Bool</i> in the command list, then the database address is interpreted as a bit address. ▪ For any other data types, the database address is interpreted as a 16-bit word (register) address.
Poll Interval	0 to 65535	Specifies the minimum interval between executions of continuous commands. The value is in tenths of a second. Therefore, if a value of 100 is entered, the command will execute no more frequently than once every 10 seconds.
Reg Count	Command-dependent	Specifies the number of 16-bit registers or binary bits transferred by the command. The range depends on the Siemens processor and the type of command. See SIE Maximum Register Counts (page 170).
Swap Code	No Change Word Swap Word and Byte Swap Byte Swap	Specifies if and how the gateway rearranges the order of bytes in data received or sent. This option exists to allow for the fact that different manufacturers store and transmit multi-byte data in different combinations. This parameter is helpful when dealing with floating-point or other multi-byte values, as there is no one standard method of storing these data types. You can set the parameter to rearrange the byte order of data received or sent into an order more useful or convenient for other applications. NO CHANGE (0) - No change is made in the byte ordering (1234 = 1234) WORD SWAP (1) -The words are swapped (1234=3412) WORD AND BYTE SWAP (2) - The words are swapped, then the bytes in each word are swapped (1234=4321) BYTE SWAP (3) - The bytes in each word are swapped (1234=2143) These swap operations affect 4-byte (or 2-word) groups of data. Therefore, use data swapping only when using an even number of words, such as 32-bit integer or floating-point data.
Node IP Address	xxx.xxx.xxx.xxx	Specifies the IP address of the Siemens processor being addressed by the command.
PLC Type	Manual TSAP, S7-300/S7-400/S7-1200	Specifies the type of Siemens processor being addressed by the command.

Rack	0 to 999	Specifies the rack number of the S7-300, S7-400 or S7-1200 CPU. Note: Rack number is not used for the S7-200 CPU.
Slot	0 to 12	Specifies the slot number of the S7-300, S7-400 or S7-1200 CPU. Note: Slot number is not used for the S7-200 CPU.
TSAP		Specifies the TSAP of the S7-200 CPU. This can be found in the Siemens STEP 7 MicroWIN software. Note: TSAP is only needed for controllers that specifically need custom TSAP settings.
Func Type	Read Write	Specifies the type of command: Read or Write.
Data Type	BOOL BYTE DINT REAL INT TIME COUNT	Specifies the data type for the command.
Address Type	INPUT OUTPUT FLAG TIMER COUNTER DB	Specifies the address type for the command. DB is Data Block.
DB Number	0 to 32767	Specifies the <i>Data Block</i> number for the command. Note: DB Number is only used when the <i>Address Type = DB</i> .
Address		Specifies the address of the data in the Siemens device. <ul style="list-style-type: none"> ▪ For Read or Write operations using the INT, DINT, REAL or BYTE Data Types, the address is a byte address. ▪ For Read or Write operations using the BOOL Data Type, the address is a bit address. See Notes on Addressing in S7 Processors (page 163).

SIE Commands Supported by Siemens Devices

The format of each command in the list depends on the Siemens Industrial Ethernet Function Code being executed. The type of supported functions also depends on the server device.

SIE S3-700 Supported Commands

Address Type: Data Block

Function	Data Type
READ	BOOL
Write	BOOL
READ	BYTE
Write	BYTE
READ	DINT
Write	DINT
READ	REAL
Write	REAL
READ	INT
Write	INT
READ	TIME
Write	TIME
READ	COUNT
Write	COUNT

Address Type: Timer

Function	Data Type
READ	TIME

Address Type: Counter

Function	Data Type
READ	COUNT

Address Type: Flag

Function	Data Type
READ	BOOL
Write	BOOL
READ	BYTE
Write	BYTE
READ	DINT
Write	DINT
READ	REAL
Write	REAL
READ	INT
Write	INT
READ	TIME
Write	TIME
READ	COUNT
Write	COUNT

Address Type: Output

Function	Data Type
READ	BOOL
Write	BOOL
READ	BYTE
Write	BYTE
READ	DINT
Write	DINT
READ	REAL
Write	REAL
READ	INT
Write	INT
READ	TIME
Write	TIME
READ	COUNT
Write	COUNT

Address Type: Input

Function	Data Type
READ	BOOL
Write	BOOL
READ	BYTE
Write	BYTE
READ	DINT
Write	DINT
READ	REAL
Write	REAL
READ	INT
Write	INT
READ	TIME
Write	TIME
READ	COUNT
Write	COUNT

SIE S7-200 Supported Commands

Address Type: Data Block

Function	Data Type
READ	BOOL
Write	BOOL
READ	BYTE
Write	BYTE
READ	DINT
Write	DINT
READ	REAL
Write	REAL
READ	INT
Write	INT

Address Type: Flag

Function	Data Type
READ	BOOL
Write	BOOL
READ	BYTE
Write	BYTE
READ	DINT
Write	DINT
READ	REAL
Write	REAL
READ	INT
Write	INT

Address Type: Output

Function	Data Type
READ	BOOL
Write	BOOL
READ	BYTE
Write	BYTE
READ	DINT
Write	DINT
READ	REAL
Write	REAL
READ	INT
Write	INT

Address Type: Input

Function	Data Type
READ	BOOL
Write	BOOL
READ	BYTE
Write	BYTE
READ	DINT
Write	DINT
READ	REAL
Write	REAL
READ	INT
Write	INT

SIE S7-1200 Supported Commands

Address Type: Data Block

Function	Data Type
READ	BOOL
Write	BOOL
READ	BYTE
Write	BYTE
READ	DINT
Write	DINT
READ	REAL
Write	REAL
READ	INT
Write	INT
READ	TIME
Write	TIME
READ	COUNT
Write	COUNT

Address Type: Flag

Function	Data Type
READ	BOOL
Write	BOOL
READ	BYTE
Write	BYTE
READ	DINT
Write	DINT
READ	REAL
Write	REAL
READ	INT
Write	INT
READ	TIME
Write	TIME
READ	COUNT
Write	COUNT

Address Type: Output

Function	Data Type
READ	BOOL
Write	BOOL
READ	BYTE
Write	BYTE
READ	DINT
Write	DINT
READ	REAL
Write	REAL
READ	INT
Write	INT
READ	TIME
Write	TIME
READ	COUNT
Write	COUNT

Address Type: Input

Function	Data Type
READ	BOOL
Write	BOOL
READ	BYTE
Write	BYTE
READ	DINT
Write	DINT
READ	REAL
Write	REAL
READ	INT
Write	INT
READ	TIME
Write	TIME
READ	COUNT
Write	COUNT

Notes on Addressing in S7 Processors

This topic applies to the S7-300 and the S7-1200 processors.

Byte Address in Data Block:

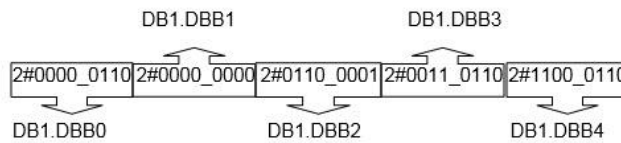

Word Address in Data Block:

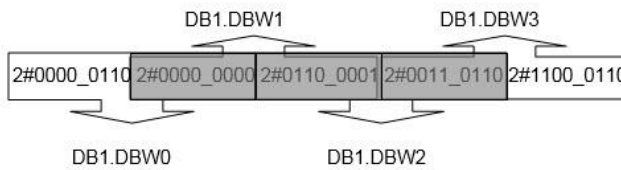

The gray area represents the byte memory locations being overlapped when the word address is used consecutively (DB1.DBW0, DB1.DBW1, DB1.DBW2, etc.).

If DB1-DBW0 is used as the first address in the Siemens processor, the next word address that can be used without overwriting the data is DB1.DBW2.

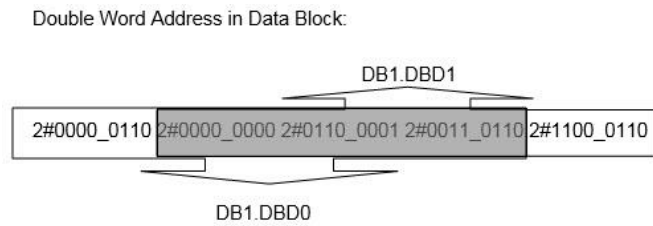

The gray area above represents the byte memory locations being overlapped when the double word address is used consecutively (DB1.DBD0, DB1.DBD1, DB1.DBD2, etc.).

If DBD1.DBD0 is used as the first address in the Siemens processor, the next double word address that can be used without overwriting the data would be DB1.DBD4.

All of the above share the same memory locations in the processor.

Note: Incorrect memory location addressing can cause the data to be overwritten.

The following image represents the addressing of the processor's memory.

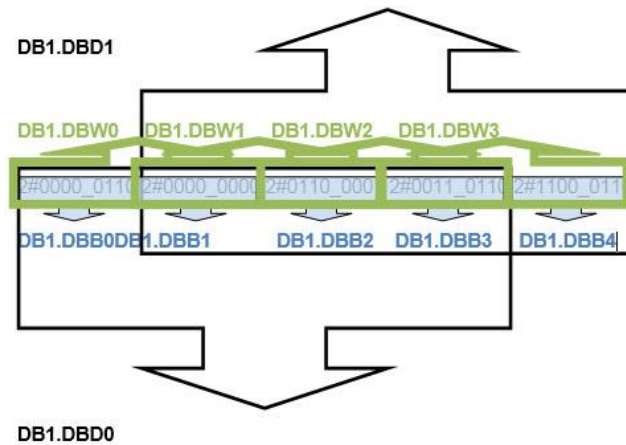

Example:

Sending an integer value of 11733 from gateway register 1000 to a Siemens S7-300 processor demonstrates the addressing scheme in the Siemens S7-300 processor. The following image from *ProSoft Configuration Builder* shows a client command sent from the gateway to INT data to DB1 address 0.

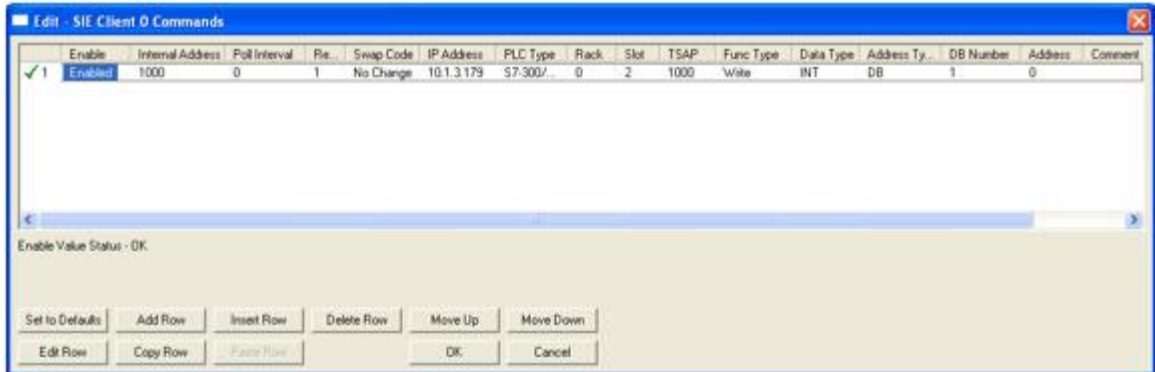

Row 1 in the SIMATIC Manager screen (below) shows the data transferred from the gateway

If the data is broken up and displayed in binary format, you can see that the binary data stored in the first byte of DB1.DBW0 is identical to that stored in byte address DB1.DBB 0. This is because the memory locations referenced by the first byte of DB1.DBW 0 and by DB1.DBB0 are one and the same, as explained above.

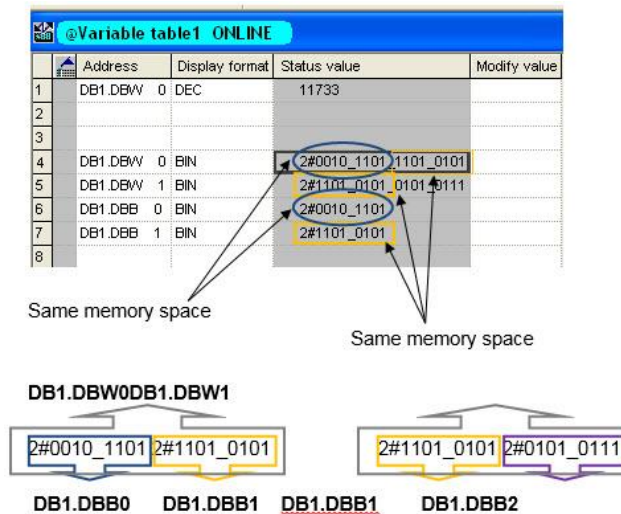

The first byte of DB1.DBW0 is the same as DB1.DBB0.

The second byte of DB1.DBW0 is the same as DB1.DBB1, and is the same as the first byte of DB1.DBW1. In reality, the memory space looks like the following:

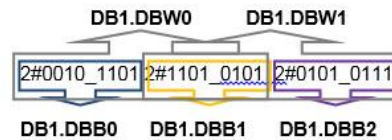

To access the first address of Data Block, Flag, Input, Output, Timer, and Counter memory locations in the S7-300 and S7-1200 processors, use the following address syntax:

- Data Block: DB1.DBB0, DB1.DBW0, DB1.DBD0
- Flag: MB0, MW0, MD0
- Input: IB0, IW0, ID0
- Output: QB0, QW0, QD0
- Timers: T0 - T65535
- Counters: C0 - C65535

To access the first address of Data Block, Flag, Input, and Output memory locations in the S7-200 processor, use the following address syntax:

- Data Block: VB0, VW0, VD0
- Flag: MB0, MW0, MD0
- Input: IB0, IW0, ID0
- Output: QB0, QW0, QD0

9.3 SIE Diagnostics

9.3.1 SIE PCB Diagnostics

The best way to troubleshoot the SIE client driver is to use ProSoft Configuration Builder to access the diagnostic capabilities of the gateway through the Ethernet debug port. For instructions on how to access the diagnostics, see Diagnostics and Troubleshooting (page 27).

The following table summarizes the status information available in PCB for the SIE driver for each client.

Connection Type	Submenu Item	Description
SIE Client [x]	Config	Configuration settings for SIE client [x].
	Status	Communication status for the SIE client [x]
	Command List	Command list for the SIE client [x]
	Command Status	Status of the commands in the SIE client [x] command list

9.3.2 SIE Status Data in Upper Memory

Each SIE client has an associated status data area located in the gateway's upper memory. You can use data mapping in the gateway to map this data into the normal user data range of the gateway's database. See Mapping Data in Module Memory (page 21).

The following table lists the starting addresses in the upper memory where the gateway stores the status data for each client:

Client	Gateway Starting Register for Status Data
0	21100
1	21125
2	21151
...	...
...	...
18	21568
19	21594

The following table describes the content of each client's status data area:

Word Offset	Description
0	Command Request Count
1	Command Response Count
2	Command Error Count
3	Number of Request Packets
4	Number of Response Packets
5	Errors Sent
6	Errors Received
7	Configuration Error Word
8	Current Error
9	Last Error
10 to 25	Command List Errors (16 per Client)

For every command that generates an error, the gateway automatically sets the poll delay parameter for that command to 30 seconds. This instructs the gateway to wait 30 seconds before it attempts to issue the command again.

As the gateway polls and executes the commands in the Client Command List, the gateway maintains an error code for each command. The gateway stores the current error value for each command in the Command List Errors section of each client's status data area. There is one register for each of the 16 commands in the command list. An error code of 0 means no error is currently detected for the specified command.

9.3.3 SIE Error Codes

SIE Module Communication Error Codes

Decimal	Hex	Description
1	0x0001	No data from I/O module
3	0x0003	The desired item is not available in the PLC (200 family)
5	0x0005	The desired address is beyond limit for this PLC
6	0x0006	The CPU does not support reading a bit block of length<>1
7	0x0007	Write data size error
10	0x000a	The desired item is not available in the PLC
-123	0xff85	Cannot evaluate the received PDU
-124	0xff84	The PLC returned a packet with no result data
-125	0xff83	The PLC returned an error code not understood by this library
-126	0xff82	This result contains no data
-127	0xff81	Cannot work with an undefined result set
-128	0xff80	Unexpected function code in answer
-129	0xff7f	PLC responds with an unknown data type
-1024	0xfc00	Short packet from PLC
-1025	0xbff	Timeout when waiting for PLC response
-32767	0x8001	Not allowed in current operating status
-32511	0x8101	Hardware fault
-32509	0x8103	Object access not allowed
-32508	0x8104	Context is not supported. Step7 says: Function not implemented or error in telegram
-32507	0x8105	Invalid address
-32506	0x8106	Data type not supported
-32505	0x8107	Data type not consistent
-32502	0x810A	Object does not exist
-31999	0x8301	Insufficient CPU memory
-31742	0x8402	CPU already in RUN or already in STOP
-31740	0x8404	Severe error
-31488	0x8500	Incorrect PDU size
-30974	0x8702	Address invalid
-12286	0xd002	Step7: Variant of command is illegal
-12284	0xd004	Step7: Status for this command is illegal
-12127	0xd0A1	Step7: Function is not allowed in the current protection level
-11775	0xd201	Block name syntax error
-11774	0xd202	Syntax error function parameter
-11773	0xd203	Syntax error block type
-11772	0xd204	No linked block in storage medium
-11771	0xd205	Object already exists

Decimal	Hex	Description
-11770	0xd206	Object already exists
-11769	0xd207	Block exists in EPROM
-11767	0xd209	Block does not exist/could not be found
-11762	0xd20e	No block present
-11760	0xd210	Block number too big
-11712	0xd240	Coordination rules were violated
-11711	0xd241	Operation not permitted in current protection level
-11710	0xd242	Protection violation while processing F-blocks. F-blocks can only be processed after password input
-11263	0xd401	Invalid SZL ID
-11262	0xd402	Invalid SZL index
-11258	0xd406	Diagnosis: Info not available
-11255	0xd409	Diagnosis: DB error

SIE Error Codes

Decimal	Hex	Description
-33	0xffdf	Failed to connect to server specified in command
-34	0xffde	Failed to create a socket
-36	0xffdc	SIE command response timeout (same as -11)
-37	0xffdb	TCP/IP connection ended before session finished

SIE Error Codes

Decimal	Hex	Description
-40	0xffd8	Too few parameters
-41	0xffd7	Invalid enable code
-42	0xffd6	Internal address > maximum address
-44	0xffd4	Count parameter set to 0
-45	0xffd3	Invalid function code
-46	0xffd2	Invalid swap code
-47	0xffd1	Invalid TSAP code

9.4 SIE Reference

9.4.1 SIE CPU315-2 DP

Address Type: Data Block

Function	Data Type	Max Reg Count	
READ	BOOL	1	
Write	BOOL		1
READ	BYTE	164	
Write	BYTE		164
READ	DINT	41	
Write	DINT		41
READ	REAL	41	
Write	REAL		41
READ	INT	82	
Write	INT		82
READ	TIME	82	
Write	TIME		41
READ	COUNT	82	
Write	COUNT		82

Address Type: Timer

Function	Data Type	Max Reg Count	
READ	TIME	1	

Address Type: Counter

Function	Data Type	Max Reg Count	
READ	COUNT	111	

Address Type: Flag

Function	Data Type	Max Reg Count	
READ	BOOL	1	
Write	BOOL		1
READ	BYTE	222	
Write	BYTE		212
READ	DINT	55	
Write	DINT		53
READ	REAL	55	
Write	REAL		53
READ	INT	111	

Write	INT		106
READ	TIME	111	
Write	TIME		53
READ	COUNT	111	
Write	COUNT		106

Address Type: Output

Function	Data Type	Max Reg Count	
READ	BOOL	1	
Write	BOOL		1
READ	BYTE	128	
Write	BYTE		128
READ	DINT	32	
Write	DINT		32
READ	REAL	32	
Write	REAL		32
READ	INT	64	
Write	INT		64
READ	TIME	64	
Write	TIME		32
READ	COUNT	64	
Write	COUNT		64

Address Type: Input

Function	Data Type	Max Reg Count	
READ	BOOL	1	
Write	BOOL		1
READ	BYTE	128	
Write	BYTE		128
READ	DINT	32	
Write	DINT		32
READ	REAL	32	
Write	REAL		32
READ	INT	64	
Write	INT		64
READ	TIME	64	
Write	TIME		32
READ	COUNT	64	
Write	COUNT		64

9.4.2 SIE CPU1212C

Address Type: Data Block

Function	Data Type	Max Read	Max Write
READ	BOOL	1	
Write	BOOL		1
READ	BYTE	30	
Write	BYTE		30
READ	DINT	7	
Write	DINT		7
READ	REAL	7	
Write	REAL		7
READ	INT	15	
Write	INT		15
READ	TIME	15	
Write	TIME		15
READ	COUNT	15	
Write	COUNT		15

Address Type: Flag

Function	Data Type	Max Reg Count	
READ	BOOL	1	
Write	BOOL		1
READ	BYTE	212	
Write	BYTE		212
READ	DINT	53	
Write	DINT		53
READ	REAL	53	
Write	REAL		53
READ	INT	106	
Write	INT		106
READ	TIME	105	
Write	TIME		105
READ	COUNT	106	
Write	COUNT		106

Address Type: Output

Function	Data Type	Max Reg Cnt	Max Reg Cnt
READ	BOOL	1	
Write	BOOL		1
READ	BYTE	212	
Write	BYTE		212
READ	DINT	53	
Write	DINT		53
READ	REAL	53	
Write	REAL		53
READ	INT	106	
Write	INT		106
READ	TIME	105	
Write	TIME		105
READ	COUNT	111	
Write	COUNT		106

Address Type: Input

Function	Data Type	Max Reg Count	
READ	BOOL	1	
Write	BOOL		1
READ	BYTE	222	
Write	BYTE		212
READ	DINT	55	
Write	DINT		53
READ	REAL	55	
Write	REAL		53
READ	INT	111	
Write	INT		111
READ	TIME	111	
Write	TIME		106
READ	COUNT	111	
Write	COUNT		106

9.4.3 SIE CPU224XP

Address Type: Data Block

Function	Data Type	Max Read	Max Write
READ	BOOL	1	
Write	BOOL		1
READ	BYTE	222	
Write	BYTE		212
READ	DINT	55	
Write	DINT		53
READ	REAL	55	
Write	REAL		53
READ	INT	111	
Write	INT		106

Address Type: Flag

Function	Data Type	Max Reg Count	
READ	BOOL	1	
Write	BOOL		1
READ	BYTE	32	
Write	BYTE		32
READ	DINT	8	
Write	DINT		8
READ	REAL	8	
Write	REAL		8
READ	INT	16	
Write	INT		16

Address Type: Output

Function	Data Type	Max Reg Count	
READ	BOOL	1	
Write	BOOL		1
READ	BYTE	16	
Write	BYTE		16
READ	DINT	4	
Write	DINT		4
READ	REAL	4	
Write	REAL		4
READ	INT	8	
Write	INT		8

Address Type: Input

Function	Data Type	Max. Reg Count	
READ	BOOL	1	
Write	BOOL		1
READ	BYTE	16	
Write	BYTE		16
READ	DINT	4	
Write	DINT		4
READ	REAL	4	
Write	REAL		4
READ	INT	8	
Write	INT		8

10 PND Protocol

In This Chapter

- ❖ PND Functional Overview 177
- ❖ PND Configuration 179
- ❖ Step 7 Configuration..... 184
- ❖ PND Diagnostics 201
- ❖ PND Performance 203

10.1 PND Functional Overview

PROFINET is the communication standard for automation of PROFIBUS and PROFINET International (PI). Many years of experience with PROFIBUS and the widespread use of Industrial Ethernet are all rolled into PROFINET.

With its integrated, Ethernet-based communication, PROFINET satisfies a wide range of requirements, from data intensive parameter assignments to extremely fast I/O data transmission which enables automation in real-time.

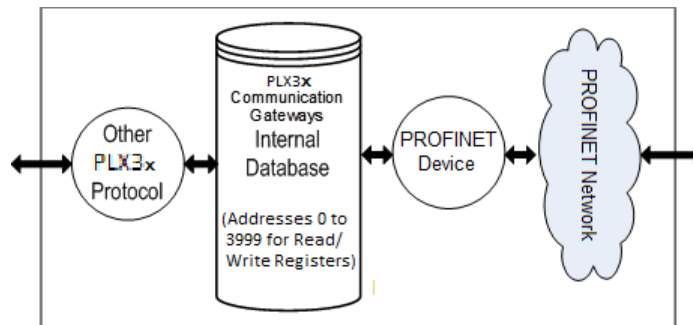

10.1.1 PND General Specifications

Driver Type	Class A Device
PROFINET I/O Data	1440 bytes IN, 1440 bytes OUT
Exchange Types	Cyclic Real-time (RT) and Acyclic Data

10.1.2 PND Internal Database

The internal database is central to the functionality of the PLX3x gateway. The gateway shares this database between all the communications ports on the gateway and uses it as a conduit to pass information from one protocol to another device on one network to one or more devices on another network. This permits data from devices on one communication port to be accessed and controlled by devices on another communication port.

In addition to data from the Controller, you can map status and error information generated by the gateway into the user data area of the internal database. The internal database is divided into two areas:

- Upper memory for the module status data area. This is where the module writes internal status data for the protocols supported by the module.
- Lower memory for the user data area. This is where incoming data from external devices is stored and accessed.

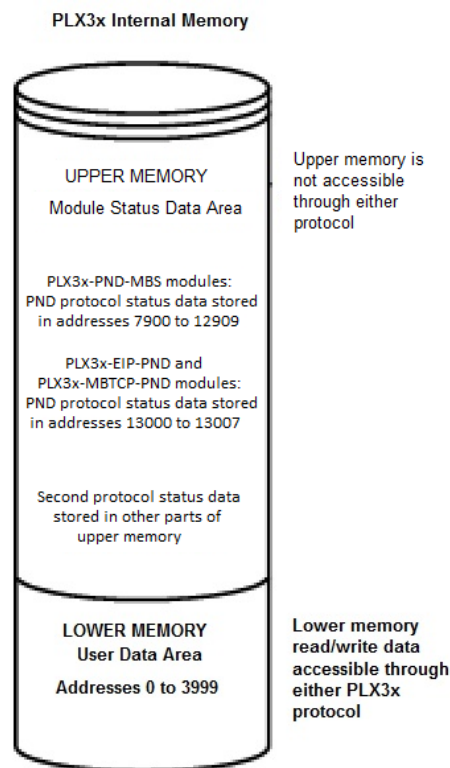

Either protocol in the PLX3x gateway can write data to and read data from the user data area. The gateway functions as a PROFINET Device, and an external PROFINET Controller can read data from, or write data to, the gateway user data area.

Note: If you want to access module status data in the upper memory, you can use the data mapping feature in the gateway to copy data from the module status data area to the user data area. See Mapping Data in Module Memory (page 21). Otherwise, you can use the diagnostic functions in ProSoft Configuration Builder to view module status data. For more information on the module status data, see PND Diagnostics (page 201).

10.2 PND Configuration

The following procedure shows how to configure a PLX3x gateway with the PND protocol using ProSoft Configuration Builder (PCB). This configuration provides the ability to communicate with a Siemens processor via the PROFINET protocol. This example uses a PLX31-EIP-PND gateway.

- 1 Launch ProSoft Configuration Builder.
- 2 Create a new PLX31-EIP-PND module.

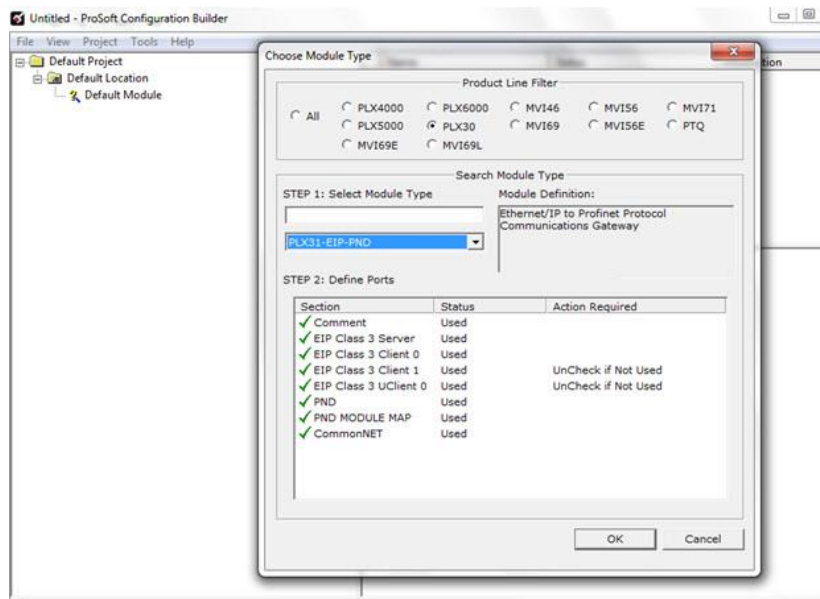

- 3 Click **OK**.

- Expand *PLX31-EIP-PND* module and double-click *PND MODULE MAP*.

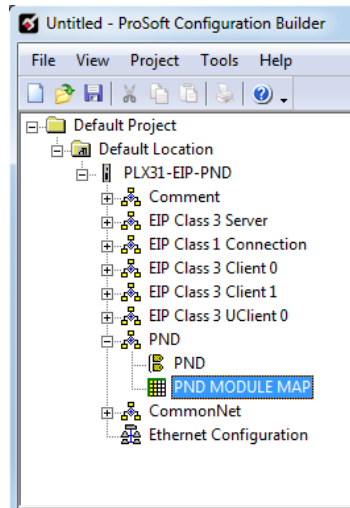

- In the *Edit - PND MODULE MAP* dialog, click **ADD ROW** and double-click on the row that appears.

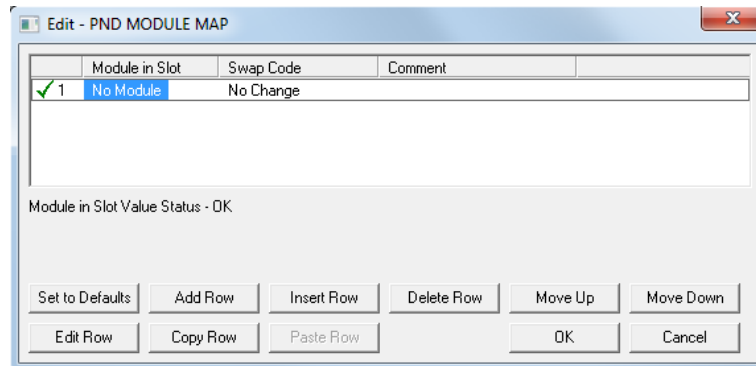

- In the *Module in Slot* field, select the number of input or output bytes to be used for each slot. This example uses 32-bytes input and 32-bytes output.

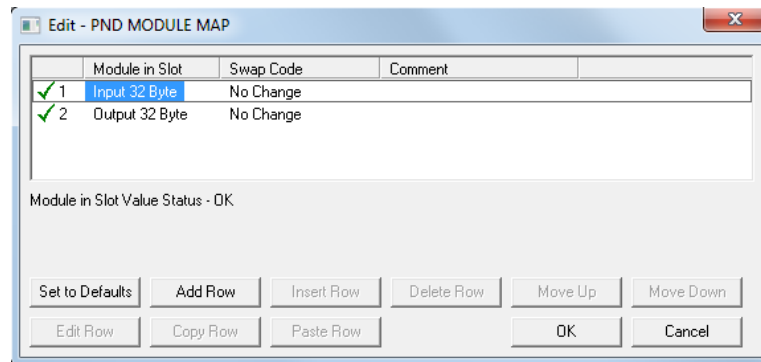
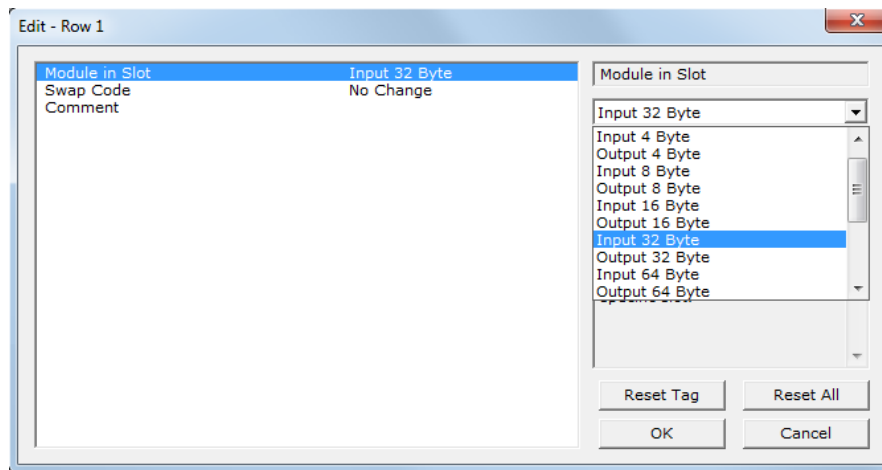

Note: The PND module map is very important because the values enter here must match the values that are entered in the Siemens processor in order for them to communicate correctly.

- Click **OK**. You can now download the configuration to the module.

10.2.1 Configuring PIE Connection

Use the *PND* section in ProSoft Configuration Builder to configure the PND communication parameters so that the gateway can communicate with a Siemens processor via the PROFINET protocol.

To configure the PND communications in PCB

- 1 In ProSoft Configuration Builder, click the **[+]** next to the gateway, then click the **[+]** next to *PND*.

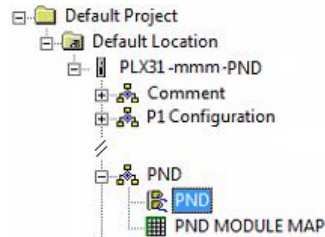

- 2 Double-click the second *PND* to display the *Edit - PND* dialog box.

In the dialog box, click a parameter and then enter a value for the parameter. The following table defines the configuration parameters for the PND communications.

Note: The gateway can store up to 720 registers (1440 bytes) of input data, and up to 720 registers of output data. Make sure that the input and output data regions do not overlap.

Parameter	Value	Description
Start Input Byte Offset	0 to 8000	Byte offset for input data in the gateway's lower memory
Start Output Byte Offset	0 to 8000	Byte offset for output data in the gateway's lower memory
Swap Read Input Data Bytes	No Change Word Swap Word and Byte Swap Byte Swap	<p>Specifies if and how the order of bytes in data received is to be rearranged. Different manufacturers store and transmit multi-byte data in different combinations. You can use this parameter when dealing with floating-point or other multi-byte values, as there is no standard method of storing these data types. You can set this parameter to rearrange the byte order of data received into an order more useful or convenient for other applications.</p> <p>NO CHANGE (0) - No change is made in the byte ordering (1234 = 1234).</p> <p>WORD SWAP (1) -The words are swapped (1234=3412).</p> <p>WORD AND BYTE SWAP (2) - The words are swapped, then the bytes in each word are swapped (1234=4321).</p> <p>BYTE SWAP (3) - The bytes in each word are swapped (1234=2143).</p> <p>These swap operations affect 4-byte (2-word) groups of data. Therefore, data swapping using <i>Swap Codes</i> should be done only when using an even number of words, such as 32-bit integer or floating-point data.</p>

Parameter	Value	Description
Swap Read Output Data Bytes	No Change Word Swap Word and Byte Swap Byte Swap	Specifies if and how the order of bytes in data sent is to be rearranged. This parameter is otherwise the same as <i>Swap Read Input Data Bytes</i> .
Comm Failure Mode	No Yes	Yes - Reset output database values to 0 if communications fail. No - Retain output database value if communications fail.

10.2.2 Configuring PND Module Map

Use the *PND Module Map* section in ProSoft Configuration Builder to configure the PND Module Map parameters.

To configure the PND Module Map in PCB

- 1 In ProSoft Configuration Builder, click the **[+]** next to the gateway, then click the **[+]** next to *PND*.

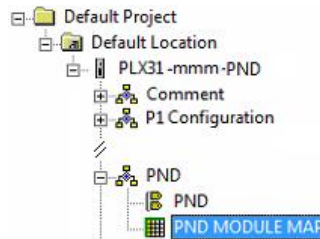

- 2 Double-click *PND MODULE MAP* to display the *Edit - PND MODULE MAP* dialog box.
- 3 Click **ADD ROW** to add a new module mapping.
- 4 Click **EDIT ROW** or double-click the row to display the *Edit* dialog box where you configure module mapping.

Parameter	Value	Description
Module in Slot	Input or Output 4, 8, 16, 32, 64, 128, 256, 512, or 1024 bytes	Specifies the module type (Input/Output) assigned to a specific slot.
Swap Code	No Change Word Swap Word and Byte Swap Byte Swap	Specifies if and how the order of bytes in data received and sent is to be rearranged. Different manufacturers store and transmit multi-byte data in different combinations. You can use this parameter when dealing with floating-point or other multi-byte values, as there is no standard method of storing these data types. You can set this parameter to rearrange the byte order of data received or sent into an order more useful or convenient for other applications.

Parameter	Value	Description
		<p>NO CHANGE (0) - No change is made in the byte ordering (1234 = 1234).</p> <p>WORD SWAP (1) -The words are swapped (1234=3412).</p> <p>WORD AND BYTE SWAP (2) - The words are swapped, then the bytes in each word are swapped (1234=4321).</p> <p>BYTE SWAP (3) - The bytes in each word are swapped (1234=2143).</p> <p>These swap operations affect 4-byte (2-word) groups of data. Therefore, data swapping using <i>Swap Codes</i> should be done only when using an even number of words, such as 32-bit integer or floating-point data.</p>
Comment		Optional 32 character comment for the module.

10.3 Step 7 Configuration

This procedure describes the steps to set up the PLX3x gateway with Siemens Step 7. It is important to note that the gateway parameters you configure and download to the gateway from ProSoft Configuration Builder must match the parameters you configure in this procedure.

- 1 Start Step 7 software.
- 2 Create a new project. For example, *Profinet_Sample*.

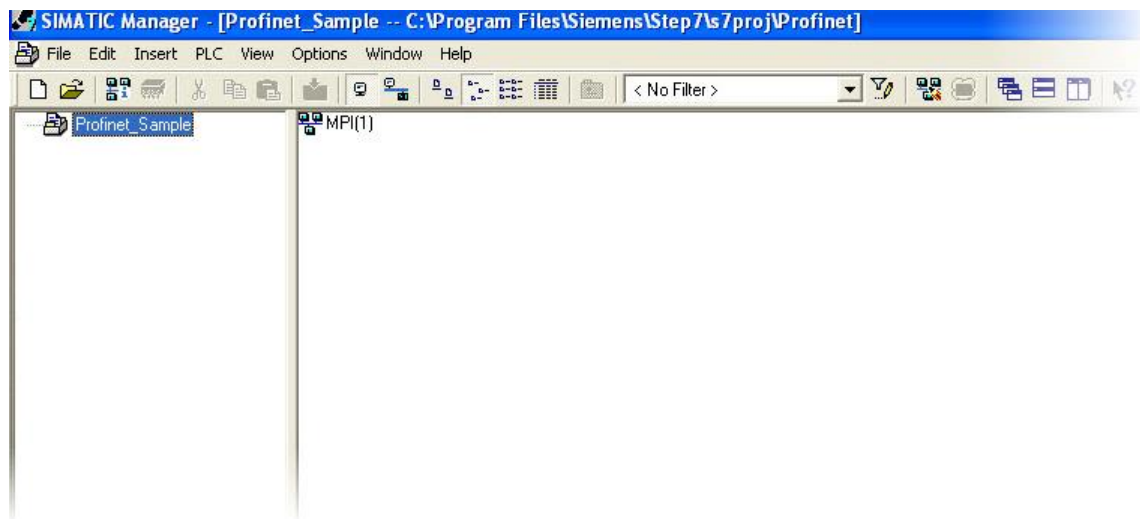

- 3 Add a station to the project in which the network will be configured.

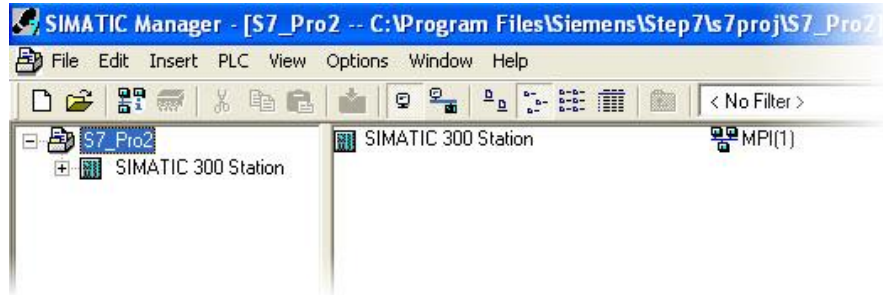

- 4 Click **SIMATIC 300 STATION**.
- 5 Double-click the hardware icon for **SIMATIC 300** to configure the station.

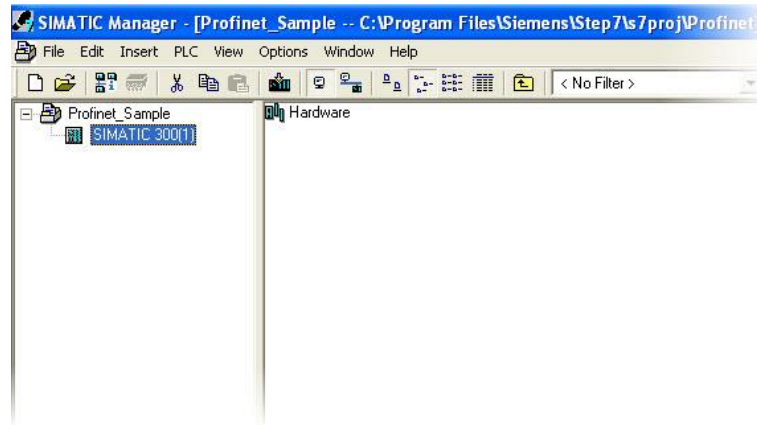

This opens the *HW Config* page.

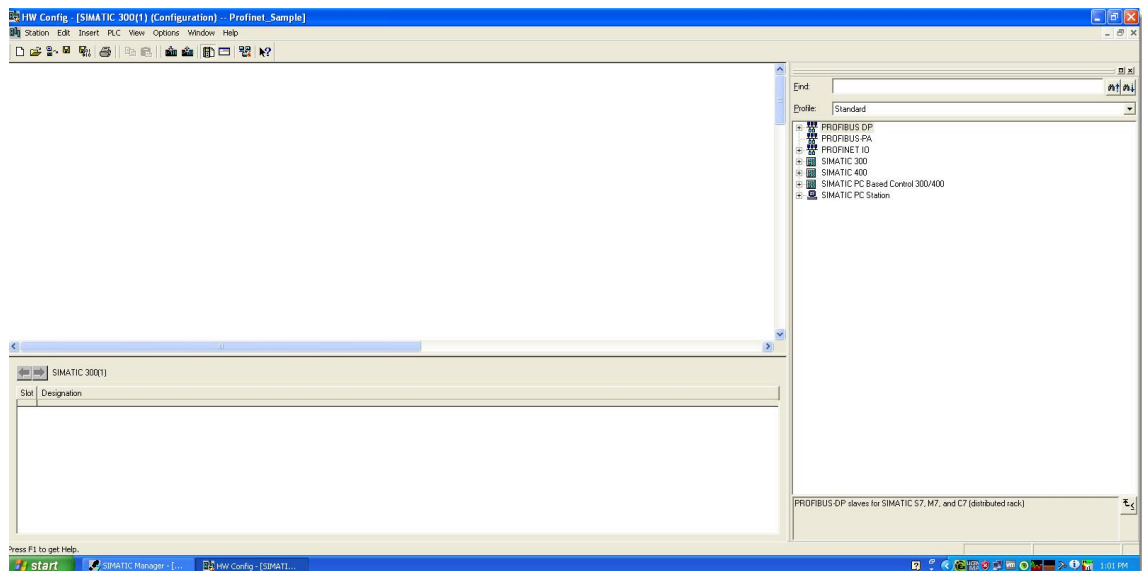

10.3.1 Creating a Variable Table to Display Floating Point Input Values

- 1 On the menu bar, click **OPTIONS** and then click **INSTALL GSD FILE**.

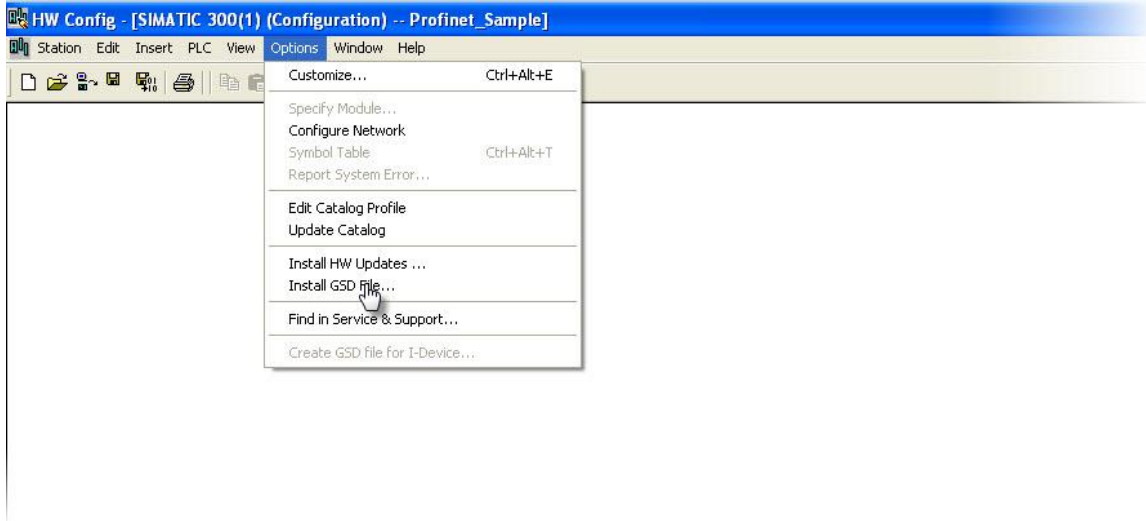

This opens the *Install GSD File* dialog box.

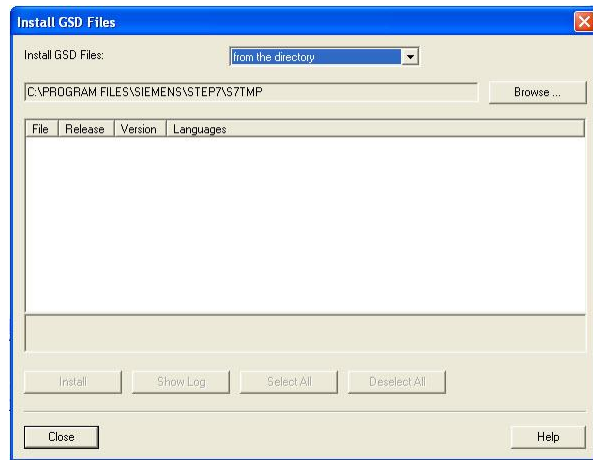

- Click **BROWSE** and browse to the location of the GSD file stored on your PC.

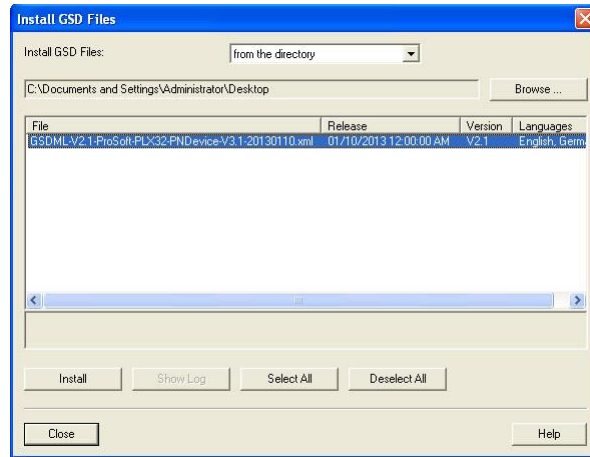

- Select the file and click **INSTALL**. The system informs you when the install is complete.

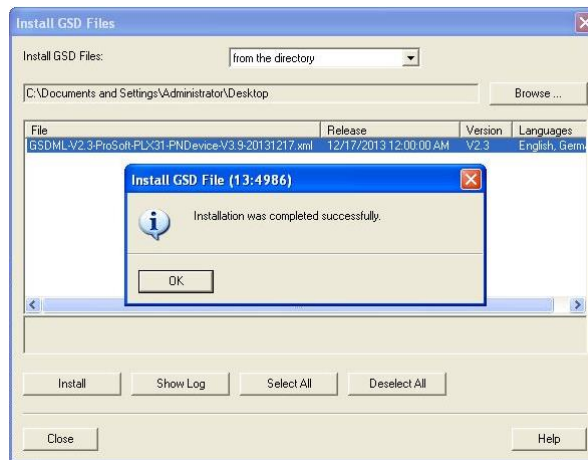

- Click **OK**.

10.3.2 Creating a Variable Table to Display Floating Point Input Values

- 1 From the *HW Config* page, select a *Rack* and a *Power Supply*.

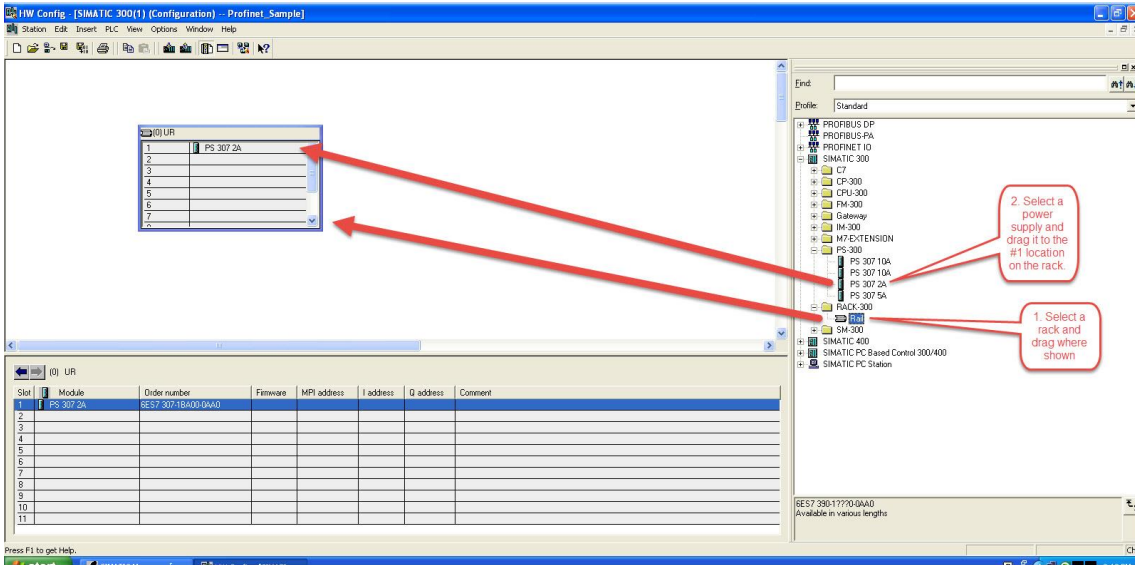

- 2 Drag and drop the processor that will be used in the network. In this example, we use 315-2 PN/DP.

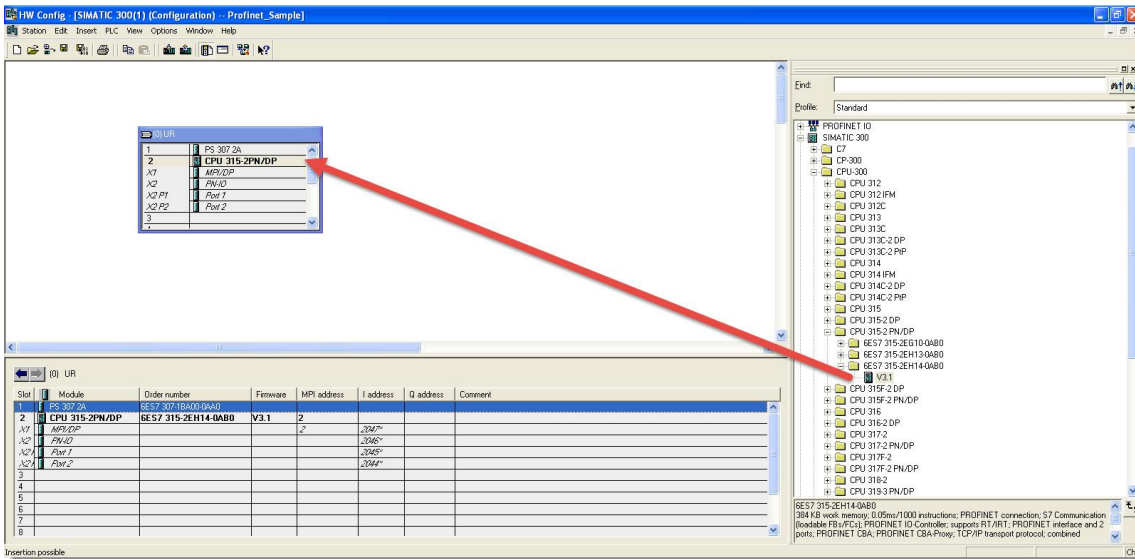

3 Right-click the **PN-IO option and then click **INSERT PROFINET IO SYSTEM**.**

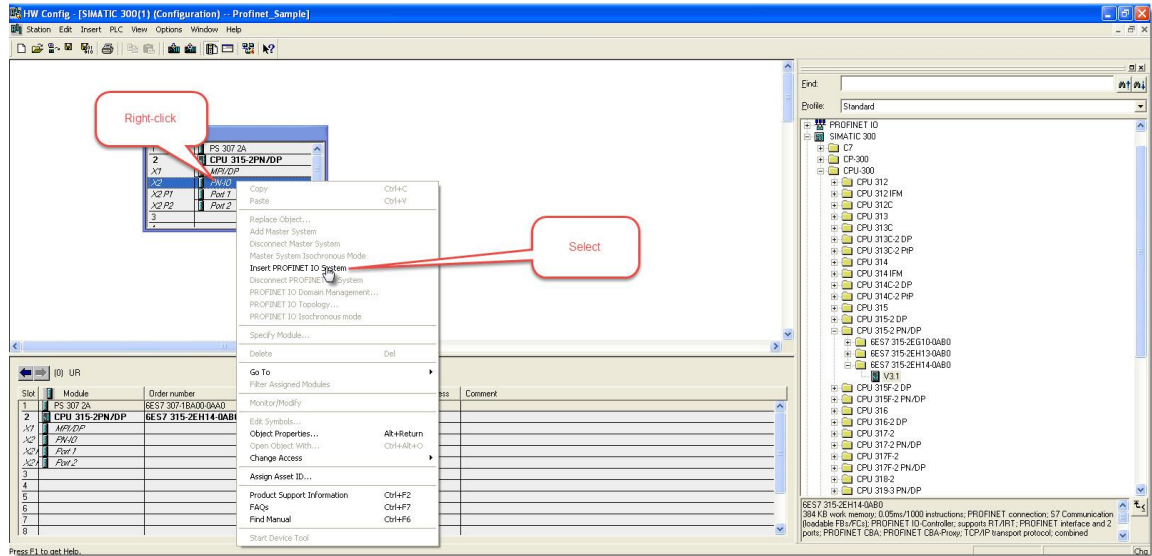

4 Insert the ProfiNet bus network where the ProSoft gateway is located by clicking the **PN-IO option and the clicking **NEW** to open *Properties - Ethernet Interface* dialog box.**

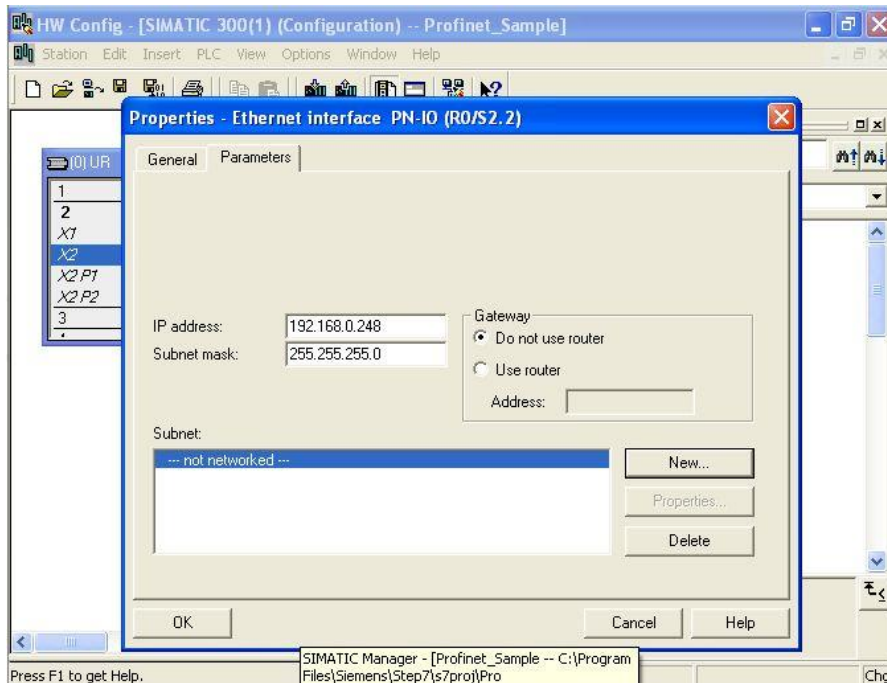

- 5 Click **NEW** to open the *Properties - New subnet Industrial Ethernet* dialog box.

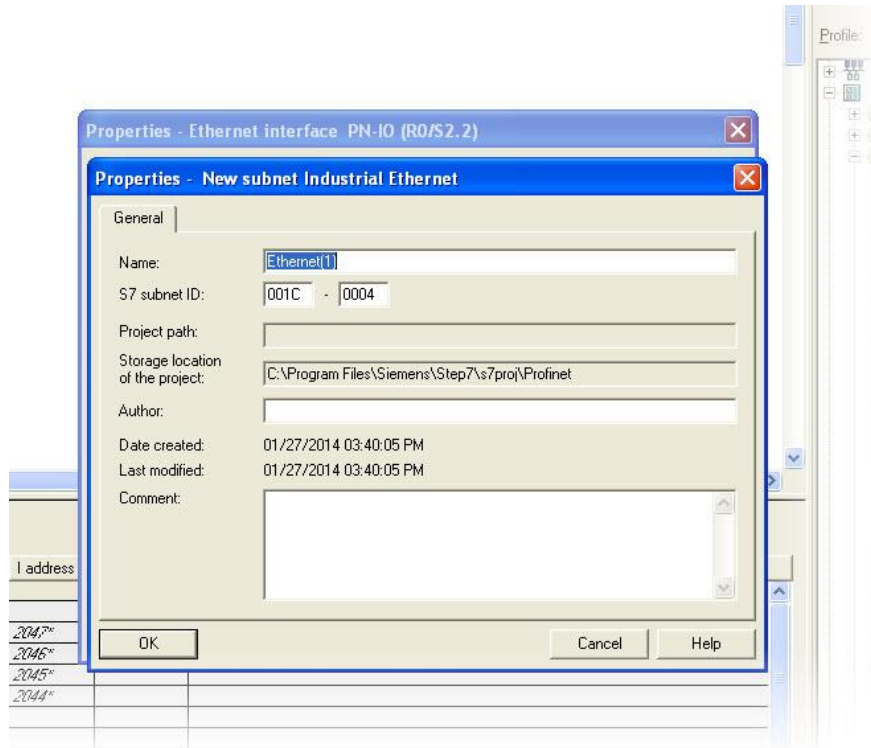

- 6 Click **OK** on the following prompt.

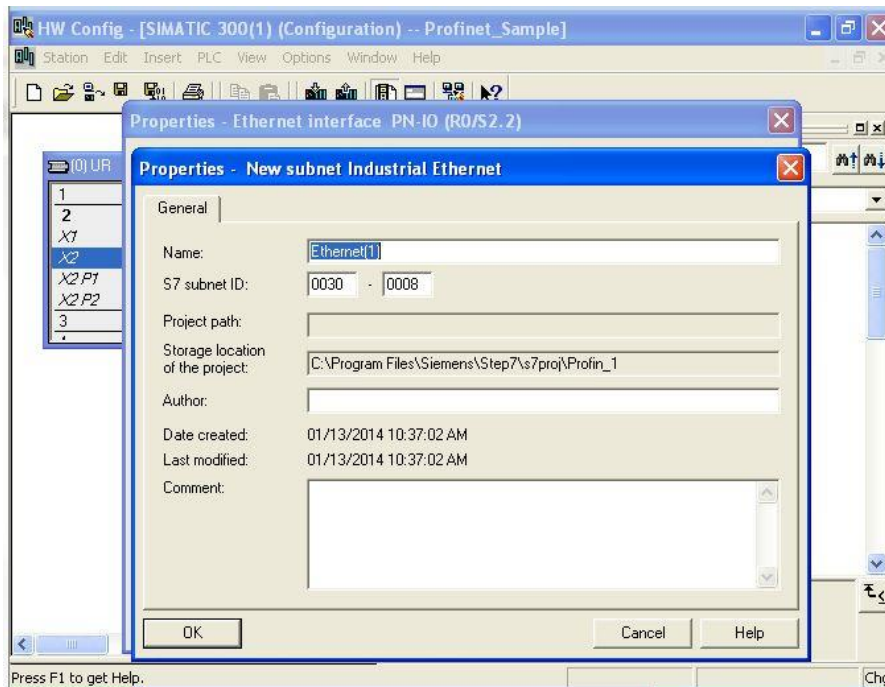

7 Add the PLX3x gateway to the network.

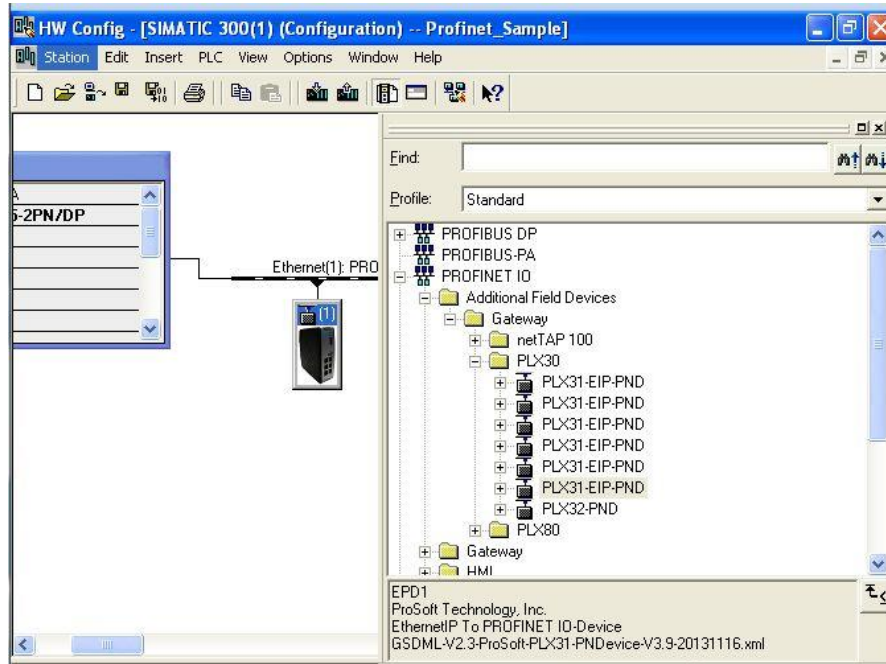

8 Configure the interface port for the ProSoft gateway as shown.

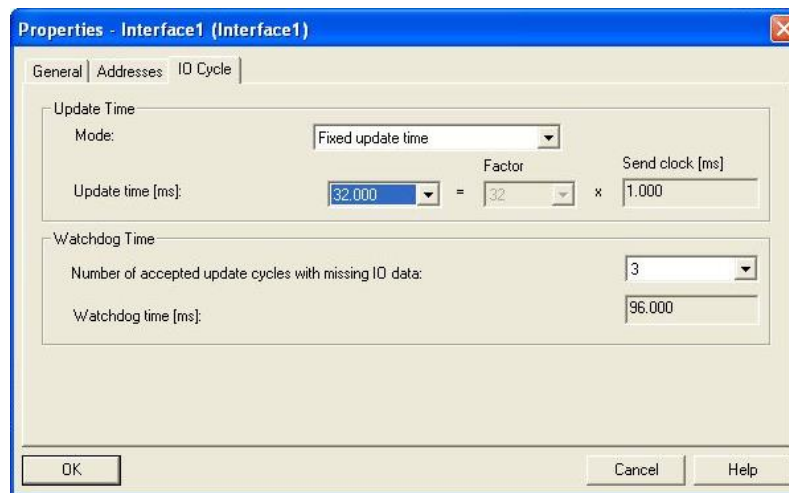

- Configure the inputs and outputs to match the PCB configuration. In this example, 32 inputs and 32 outputs were configured in the module.

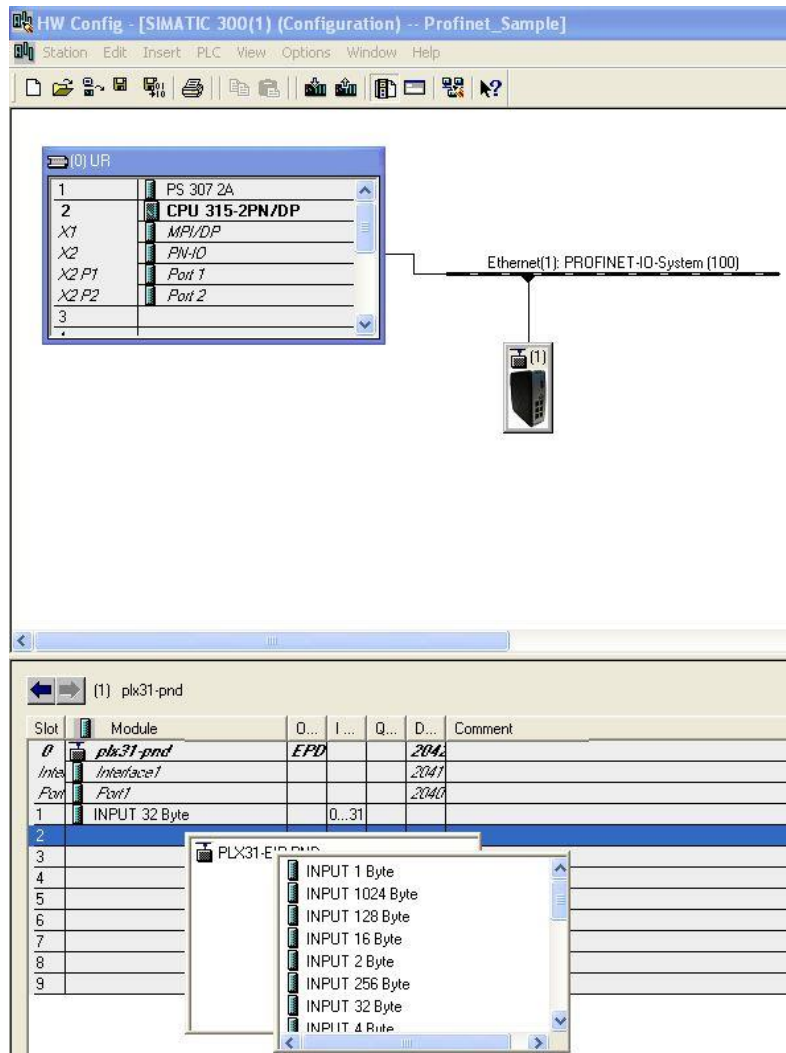

10 Verify the name and IP address as shown.

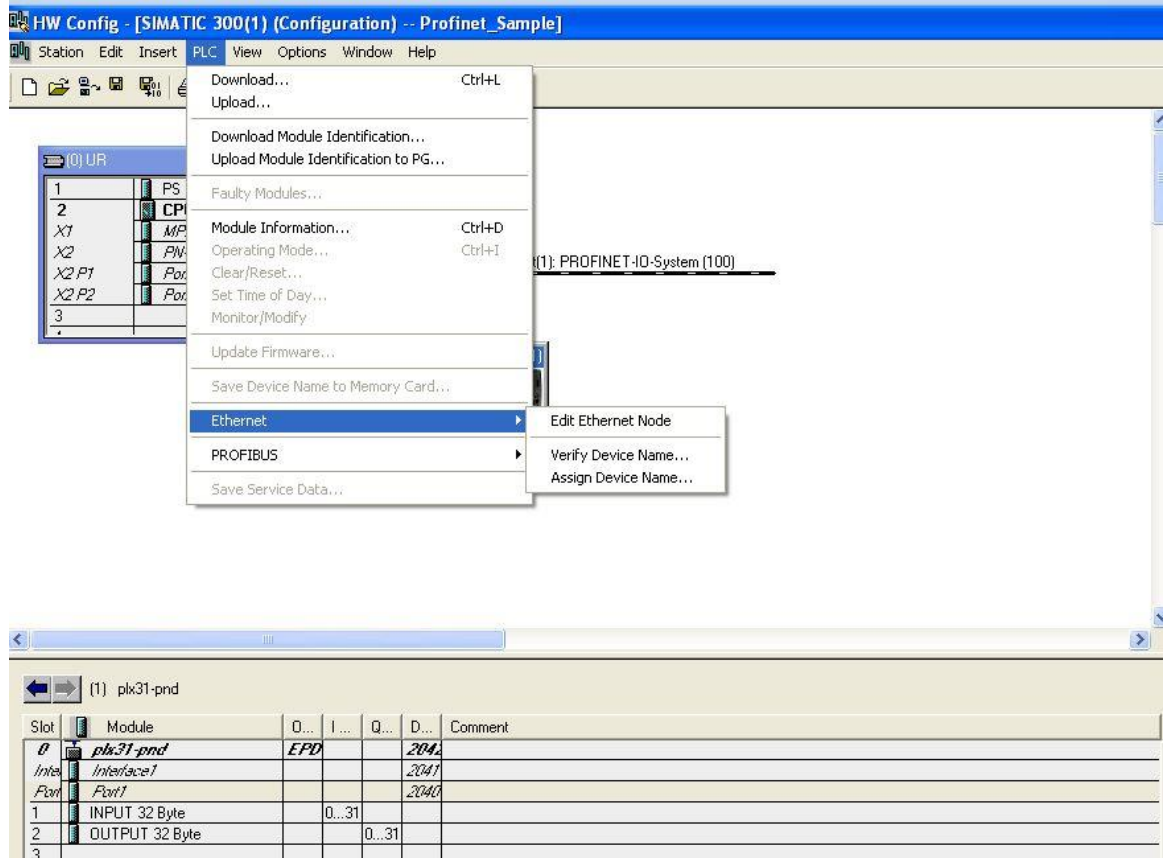

11 If the module is correctly configured, the following appears. If the status is not a green checkmark, you must assign the gateway name and IP by selecting the gateway and then clicking **ASSIGN NAME**.

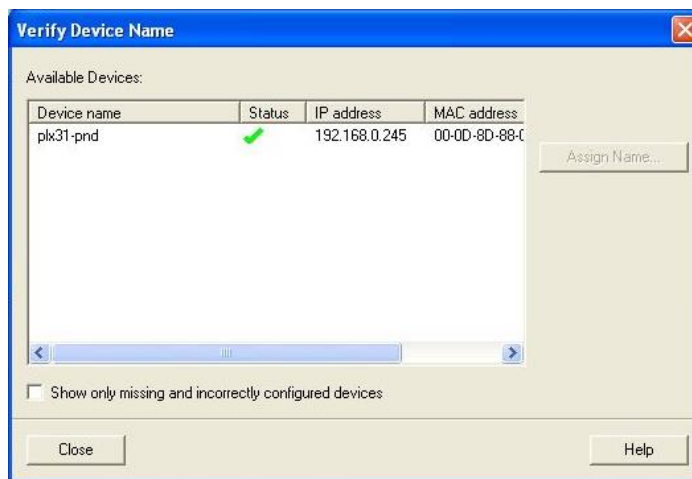

The following image shows an example:

Edit Ethernet Node

Ethernet node

Nodes accessible online

MAC address:

Set IP configuration

Use IP parameters

IP address: Gateway

Subnet mask: Do not use router

Use router

Address:

Obtain IP address from a DHCP server

Identified by

Client ID MAC address Device name

Client ID:

Assign device name

Device name:

Reset to factory settings

12 Save and download the program.

The screenshot displays the SIMATIC Manager interface. At the top, a menu bar includes Station, Edit, Insert, PLC, View, Options, Window, and Help. Below the menu is a toolbar with various icons. The main workspace shows a hardware rack configuration for a SIMATIC 300 station:

Slot	Module
1	PS 307 2A
2	CPU 315-2PN/DP
X1	MPI/DP
X2	PN-I/O
X2.P1	Port 1
X2.P2	Port 2
3	

The rack is connected to an Ethernet network labeled "Ethernet(1): PROFINET-I/O-System (100)". A "Download" dialog box is open, and a "Select Node Address" dialog box is also open. The "Select Node Address" dialog box contains the following information:

Station: SIMATIC 300
Module: [0/2/0] CPU 315-2PN/DP

Over which station address is the programming device connected to the module CPU 315-2PN/DP?

Rack: 0
Slot: 2

Target Station: Local
 Can be reached by means of gateway

Enter connection to target station:

IP address	MAC address	Module type	Station name	Module name	P
192.168.0.248		CPU 315-...	SIMATIC 300	CPU 315-2...	

Accessible Nodes: (Empty list)

Buttons: View, OK, Cancel, Help

At the bottom of the main workspace, a table shows the hardware configuration for the selected module:

Slot	Module	I...	Q...	D...	Comment
0	plx31-pnd	EPD		204	
Interface				2041	
Port				2040	
1	INPUT 32 Byte	0...31			
2	OUTPUT 32 Byte		0...31		
3					
4					
5					
6					
7					
8					
9					

Once you download the program, the RUN LED and the DC5V on the processor should be green. There should be no red LEDs.

The screenshot shows the SIMATIC Manager HW Config interface. The top part displays a rack configuration for a SIMATIC 300 system. The rack contains the following modules:

- Slot 1: PS 307 2A
- Slot 2: CPU 315-2PN/DP
- X1: MPI/DP
- X2: PN-IO
- X2.P1: Port 1
- X2.P2: Port 2
- Slot 3: (Empty)

The rack is connected to an Ethernet network labeled "Ethernet(1): PROFINET-IO-System (100)".

The bottom part of the screenshot shows a diagnostic table for the module (1) plx31-pnd. The table has the following columns: Slot, Module, Order number, I address, Q address, Diagnostic address, and Comment.

Slot	Module	Order number	I address	Q address	Diagnostic address:	Comment
0	plx31-pnd	EPD1			2042*	
Interface	Interface1				2041*	
Port	Port1				2040*	
1	INPUT 32 Byte		0...31			
2	OUTPUT 32 Byte			0...31		
3						
4						
5						
6						
7						
8						
9						

10.3.3 Creating a Variable Table to Display Floating Point Input Values

- 1 To monitor the values coming out of the processor, click the *Input* and then click **MONITOR/MODIFY**.

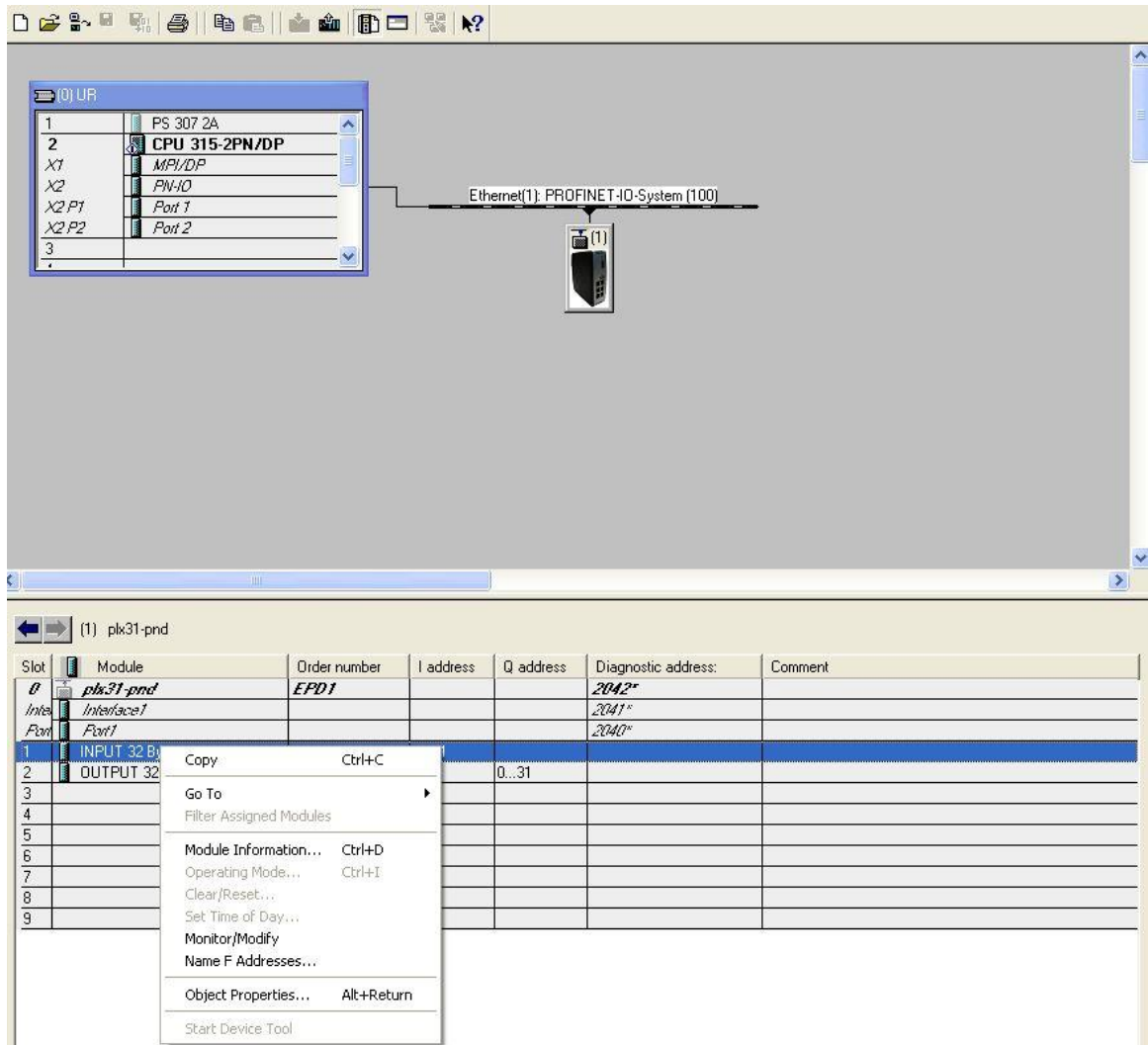

The values coming into the processor are displayed at the input section.

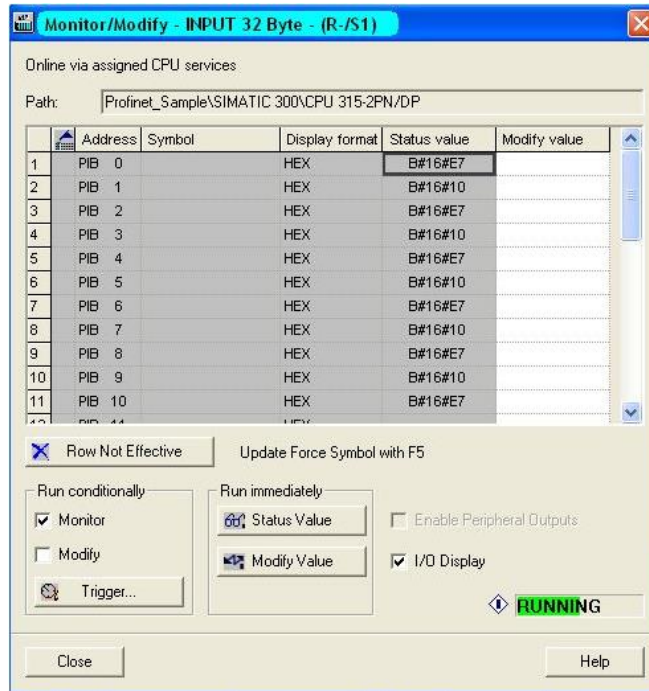

- 2 To modify the values that the processor sends to the module, choose the output, select the desired value, and click **MODIFY VALUE**.

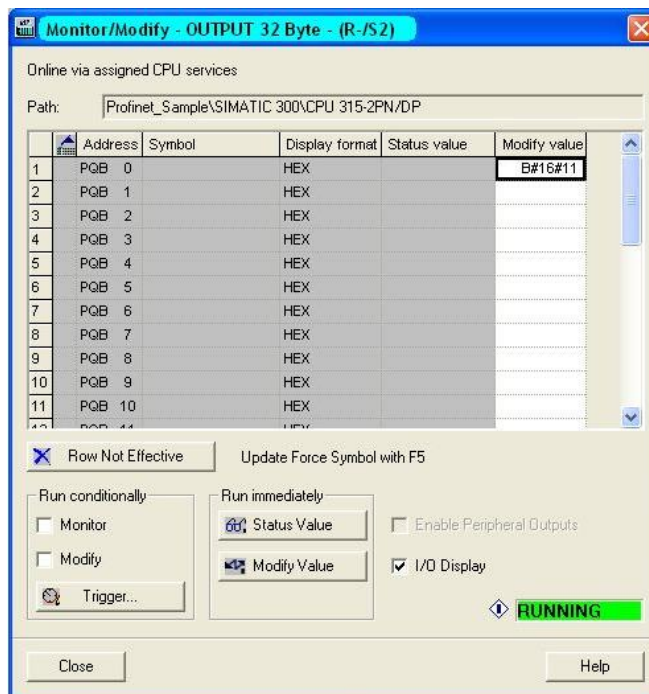

10.3.4 Creating a Variable Table to Display Floating Point Input Values

- 1 On the menu bar, click **INSERT NEW OBJECT** and then click **VARIABLE TABLE**.

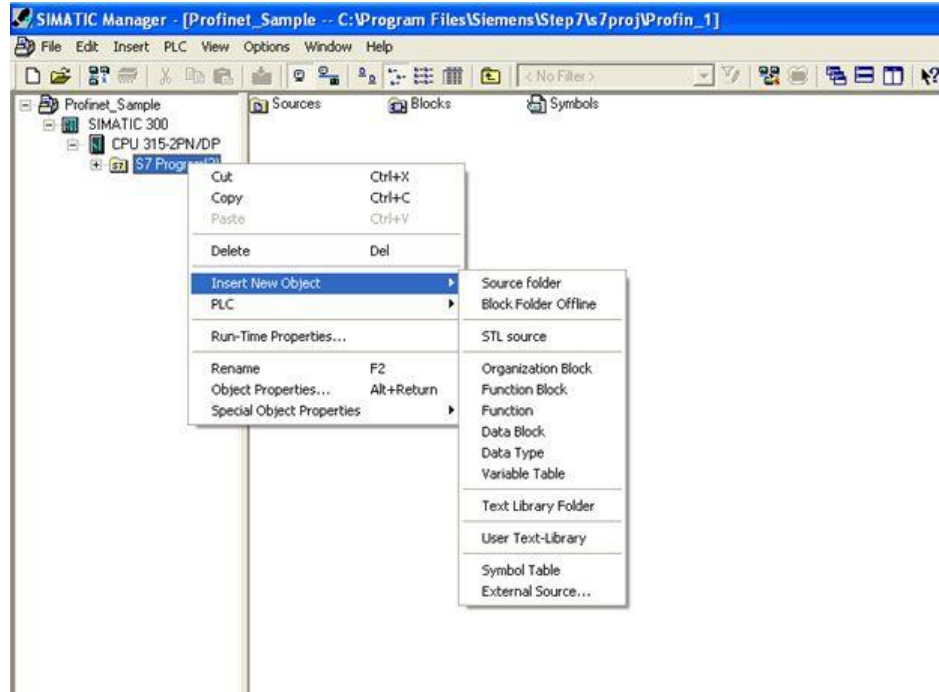

- 2 Enter a name for the table.

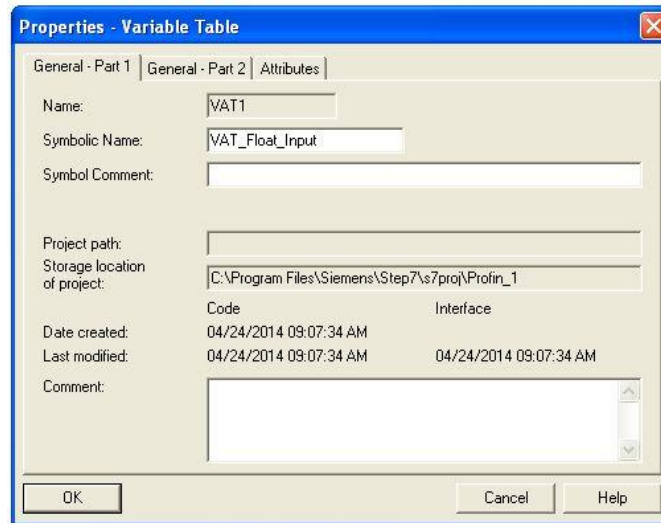

3 Double-click the table.

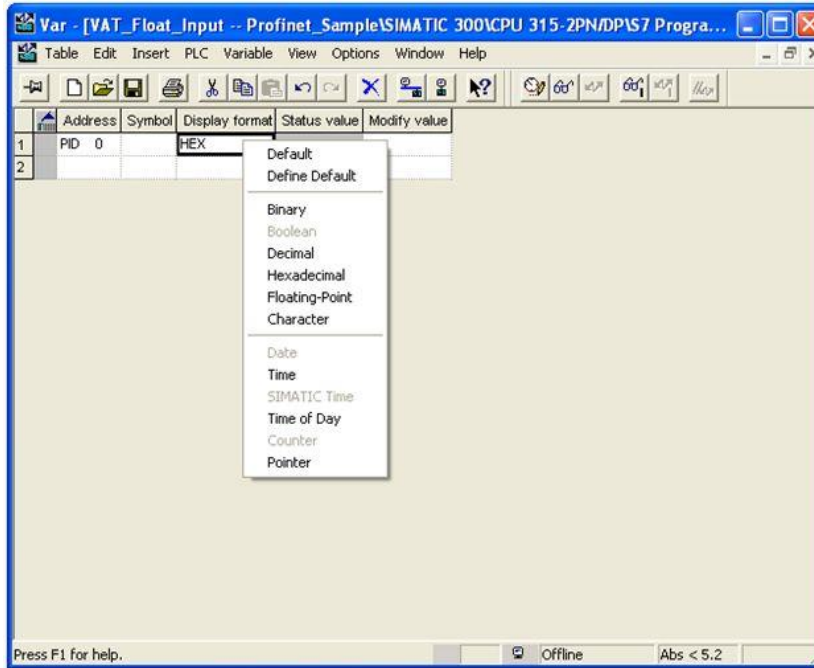

4 Monitor the value.

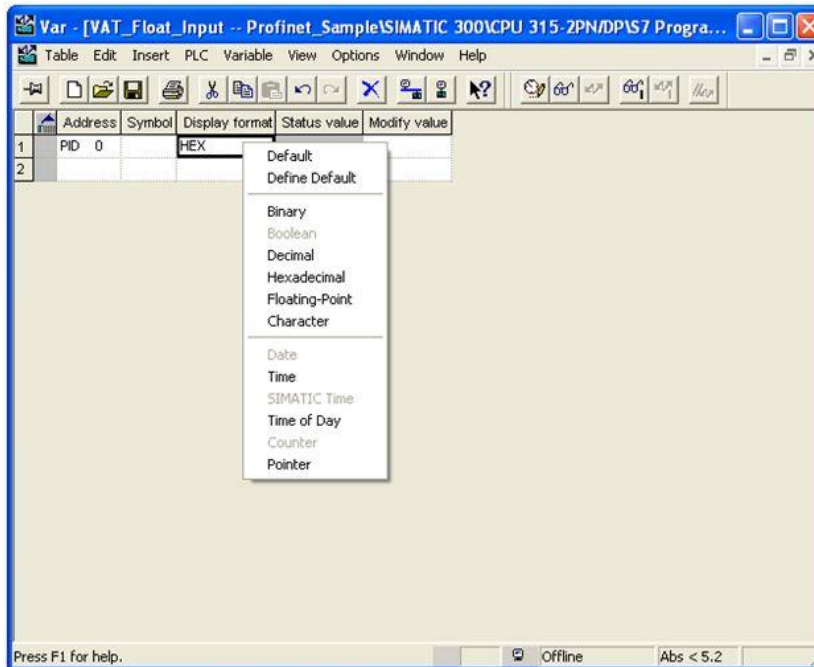

10.4 PND Diagnostics

10.4.1 PND PCB Diagnostics

The best way to troubleshoot the SIE client driver is to use ProSoft Configuration Builder to access the diagnostic capabilities of the gateway through the Ethernet debug port. For instructions on how to access the diagnostics, see Diagnostics and Troubleshooting (page 27).

The following table summarizes the status information available in PCB for the PND driver:

Connection Type	Submenu Item	Description
PROFINET	Config	Configuration settings for PROFINET
	Module Map	Module Map settings for PROFINET
	Status	Communication status for PROFINET

10.4.2 PND Status Data in Upper Memory

The PND driver has an associated status data area located in the gateway's upper memory. You can use data mapping in the gateway to map this data into the normal user data range of the gateway's database. See Mapping Data in Module Memory (page 21).

The following table lists the locations in the gateway's upper memory area for the general status and error data:

<ul style="list-style-type: none"> ▪ PLX31-PND-MBS ▪ PLX31-PND-MBS4 	The gateway stores status data in the upper memory area starting at address 6000
<ul style="list-style-type: none"> ▪ PLX31-EIP-PND ▪ PLX32-EIP-PND ▪ PLX31-MBTCP-PND ▪ PLX32-MBTCP-PND 	The gateway stores status data in the upper memory area starting at address 13000.

The following table lists the specific status data:

Register	Description
6000 / 13000	Total number of write messages to PLC
6001 / 13001	Total number of write message errors
6002 / 13002	Input Error message status. See below for error code descriptions.
6003 / 13003	Total number of read messages from PLC
6004 / 13004	Total number of read message errors
6005 / 13005	Output Error message status. See below for error code descriptions.
6006 / 13006	Connection Status
6007 / 13007	Driver Enabled? 1=Yes, 0=No

10.4.3 Input/Output Error Message Status Codes

Input Error Message Status	Description
0	No error
0x0604	Pointer to data memory is NULL
0x0503	Write buffer is already locked or unlocked
0x060A	Data length to be written is invalid

Output Error Message Status	Description
0	No error
0x0001	No new data was copied into the buffer
0x0604	Pointer to data memory is NULL, or pointer to variable to receive the APDU Data Status is NULL
0x060B	IOCR ID is 0
0x0803	IOCR ID could not be found, or IOCR ID is invalid
0x060A	Data length to be read is invalid

10.4.4 Configuration Error Codes

The ERR LED on the PLX3x gateway faceplate is lit when no connection from the Controller is established.

Error Code	Description
0	No error
1	Input Swap Error
2	Output Swap Error
18	Get Network Data Adapter
19	Get IP Address Error
20	Get NetMask Error
21	Get Gateway Error
22	Get MAC Address Error
23	PROFINET Mapping Error

10.5 PND Performance

The following tables contain PND performance rates.

EIP Class 1 Connections RPI (ms)	Number of EIP Class 1 Connections							
	1	2	3	4	5	6	7	8
2	128 Bytes	128 Bytes	128 Bytes	128 Bytes	128 Bytes	128 Bytes	128 Bytes	128 Bytes
	256 Bytes	256 Bytes	256 Bytes	256 Bytes	256 Bytes	256 Bytes	NA	NA
	496 Bytes	496 Bytes	496 Bytes	NA	NA	NA	NA	NA
4	128 Bytes	128 Bytes	128 Bytes	128 Bytes	128 Bytes	128 Bytes	128 Bytes	128 Bytes
	256 Bytes	256 Bytes	256 Bytes	256 Bytes	256 Bytes	256 Bytes	NA	NA
	496 Bytes	496 Bytes	496 Bytes	NA	NA	NA	NA	NA
8	128 Bytes	128 Bytes	128 Bytes	128 Bytes	128 Bytes	128 Bytes	128 Bytes	128 Bytes
	256 Bytes	256 Bytes	256 Bytes	256 Bytes	256 Bytes	256 Bytes	NA	NA
	496 Bytes	496 Bytes	496 Bytes	NA	NA	NA	NA	NA

PROFINET Update Rate (ms)	PROFINET I/O Size (bytes)						
	128	256	512	768	1024	1280	1400
2*	YES	NO	NO	NO	NO	NO	NO
4*	YES	YES	YES	NO	NO	NO	NO
8	YES	YES	YES	YES	YES	YES	YES

Example:

PLX3x gateway sending/receiving 128 bytes of EIP data on a single 4 ms Class 1 connection and PLX3x gateway sending/receiver 128 bytes of PROFINET data with a 4 ms update rate.

The maximum cycle time is calculated as:

EIP = 4 ms/in + 4 ms/out = 8 ms

PND = 4 ms/in + 4 ms/out = 8 ms

PLX3x latency = 4 ms

Total: 20 ms

- To use a 2 to 4 ms update rate, you must use a different GSDML file. This GSDML is available at www.prosoft-technology.com
- Under certain conditions (high network load, low update rate, etc.) the PROFINET Controller may need to raise the watchdog time.

11 Support, Service & Warranty

In This Chapter

- ❖ Contacting Technical Support205
- ❖ Warranty Information207

11.1 Contacting Technical Support

ProSoft Technology, Inc. is committed to providing the most efficient and effective support possible. Before calling, please gather the following information to assist in expediting this process:

- 1 Product Version Number
- 2 System architecture
- 3 Network details

If the issue is hardware related, we will also need information regarding:

- 1 Module configuration and associated ladder files, if any.
- 2 Module operation and any unusual behavior
- 3 Configuration/Debug status information
- 4 LED patterns
- 5 Details about the serial, Ethernet or Fieldbus devices interfaced to the module, if any.

Note: For technical support calls within the United States, ProSoft's 24/7 after-hours phone support is available for urgent plant-down issues. Detailed contact information for all our worldwide locations is available on the following page.

Asia Pacific	Europe / Middle East / Africa
<p>Regional Office Phone: +603.7724.2080 asiapc@prosoft-technology.com Languages spoken: Bahasa, Chinese, English, Japanese, Korean REGIONAL TECH SUPPORT support.ap@prosoft-technology.com</p> <p>North Asia (China, Hong Kong) Phone: +86.21.5187.7337 china@prosoft-technology.com Languages spoken: Chinese, English REGIONAL TECH SUPPORT support.ap@prosoft-technology.com</p> <p>Southwest Asia (India, Pakistan) Phone: +91.98.1063.7873 india@prosoft-technology.com Languages spoken: English, Hindi, Urdu</p> <p>Australasia (Australia, New Zealand) Phone: +603.7724.2080 pacific@prosoft-technology.com Language spoken: English</p> <p>Southeast Asia (Singapore, Indonesia, Philippines) Phone: +603.7724.2080 seasia@prosoft-technology.com Languages spoken: English, Bahasa, Tamil</p> <p>Northeast & Southeast Asia (Japan, Taiwan, Thailand, Vietnam, Malaysia) Phone: +603.7724.2080 neasia@prosoft-technology.com Languages spoken: English, Chinese, Japanese</p> <p>Korea Phone: +603.7724.2080 korea@prosoft-technology.com Languages spoken: English, Korean</p>	<p>Regional Office Phone: +33.(0)5.34.36.87.20 europe@prosoft-technology.com Languages spoken: French, English REGIONAL TECH SUPPORT support.emea@prosoft-technology.com</p> <p>Middle East & Africa Phone: +971.4.214.6911 mea@prosoft-technology.com Languages spoken: Hindi, English REGIONAL TECH SUPPORT support.emea@prosoft-technology.com</p> <p>North Western Europe (UK, IE, IS, DK, NO, SE) Phone: +44.(0)7415.864.902 nweurope@prosoft-technology.com Language spoken: English</p> <p>Central & Eastern Europe, Finland Phone: +48.22.250.2546 centraleurope@prosoft-technology.com Languages spoken: Polish, English, Russian & CIS Phone: +7.499.704.53.46 russia@prosoft-technology.com Languages spoken: Russian, English</p> <p>Austria, Germany, Switzerland Phone: +33.(0)5.34.36.87.20 germany@prosoft-technology.com Language spoken: English, German</p> <p>BeNeLux, France, North Africa Phone: +33(0)5.34.36.87.27 france@prosoft-technology.com Languages spoken: French, English</p> <p>Mediterranean Countries Phone: +39.342.8651.595 italy@prosoft-technology.com Languages spoken: Italian, English, Spanish</p>

Latin America	North America
<p>Regional Office Phone: +52.222.264.1814 support.la@prosoft-technology.com Languages spoken: Spanish, English REGIONAL TECH SUPPORT support.la@prosoft-technology.com</p> <p>Brazil Phone: +55.11.5084.5178 brasil@prosoft-technology.com Languages spoken: Portuguese, English REGIONAL TECH SUPPORT support.la@prosoft-technology.com</p> <p>Mexico Phone: +52.222.264.1814 mexico@prosoft-technology.com Languages spoken: Spanish, English REGIONAL TECH SUPPORT support.la@prosoft-technology.com</p> <p>Andean Countries, Central America & Caribbean Phone: +507.6427.48.38 andean@prosoft-technology.com Languages spoken: Spanish, English</p> <p>Southern Cone (Argentina, Bolivia, Chile, Paraguay & Uruguay) Phone: +54.911.4565.8119 scone@prosoft-technology.com Languages spoken: Spanish, English</p>	<p>Regional Office Phone: +1.661.716.5100 info@prosoft-technology.com Languages spoken: English, Spanish REGIONAL TECH SUPPORT support@prosoft-technology.com</p>

11.2 Warranty Information

For complete details regarding ProSoft Technology’s TERMS & CONDITIONS OF SALE, WARRANTY, SUPPORT, SERVICE AND RETURN MATERIAL AUTHORIZATION INSTRUCTIONS, please see the documents at:
www.prosoft-technology/legal

Documentation is subject to change without notice.

Index

A

About the Modbus Protocol • 35, 102, 108, 121, 130
 Accessing the Gateway's Internal Memory • 49
 Adding the Gateway to RSLogix5000 v.16 through v.19 • 54
 Adding the Gateway to RSLogix5000 v.20 • 52
 Agency Approvals and Certifications • 3
 ASCII Configuration • 136, 138
 ASCII Data Flow • 132
 ASCII Diagnostics • 136, 143
 ASCII Error Codes • 148
 ASCII Functional Overview • 131
 ASCII Internal Database • 135
 ASCII Modes of Operation • 136
 ASCII PCB Diagnostics • 143
 ASCII Port [x] • 138
 ASCII Port Driver Status • 144
 ASCII Protocol • 131
 ASCII Status Data in Upper Memory • 37, 144

B

Basic Command Set Functions • 51
 BT • 79

C

Capturing a Diagnostic Session to a Log File • 33
 CIP Data Table Operations • 85
 CIP Data Table Read • 87
 CIP Data Table Write • 85
 Class 3 Client/UClient [x] Commands SLC500 2
 Address Fields • 58
 Class 3 Client[x]/UClient • 56
 Class 3 Client[x]/UClient Commands • 57
 Class 3 Client[x]/UClient Commands Basic • 65
 Class 3 Client[x]/UClient Commands CIP Generic • 63
 Class 3 Client[x]/UClient Commands Controller Tag
 Access • 62
 Class 3 Client[x]/UClient Commands PLC5 ASCII • 61
 Class 3 Client[x]/UClient Commands PLC5 Binary • 60
 Class 3 Client[x]/UClient Commands SLC500 3
 Address Fields • 59
 Common Response Error Codes • 71
 Configuration Error Codes • 202
 Configuration Parameters Common to Master and
 Slave • 117
 Configuring a Port for Transmit-Only Mode • 141
 Configuring a Port for Transmit-Receive Mode • 141
 Configuring EIP Class 1 Connection • 52
 Configuring EIP Class 1 Connections in PCB • 55
 Configuring EIP Class 3 Client[x]/UClient Connection •
 56
 Configuring EIP Class 3 Server • 49

Configuring Gateway Parameters • 20
 Configuring MBS Port [x] • 115
 Configuring MBTCP Client [x] • 99
 Configuring MBTCP Client [x] Commands • 101
 Configuring MBTCP Servers • 96, 97
 Configuring PIE Connection • 182
 Configuring PND Module Map • 183
 Configuring SIE Client [x] Connection • 153
 Configuring SIE Client x Commands • 154
 Configuring the Ethernet Port • 16, 20
 Configuring the Port for Receive-Only Mode • 141
 Connecting Power to the Unit • 13
 Connecting the PC to the Gateway • 15, 24, 25
 Contacting Technical Support • 205
 Content Disclaimer • 2
 Control • 79
 ControlLogix and CompactLogix Processor Specifics •
 80
 Creating a Variable Table to Display Floating Point
 Input Values • 186, 188, 197, 199

D

Delay Preset • 23
 Diagnostics and Troubleshooting • 27, 104, 123, 138,
 143, 166, 201
 Diagnostics Menu • 30, 32, 36
 Disabling Gateway Ports • 17
 Downloading the Project to the Gateway • 24

E

EIP Client Access to Database • 48
 EIP Client Command List Error Data • 67
 EIP Client Status Data • 67
 EIP Command Entry Form • 89
 EIP Configuration • 49
 EIP Error Codes • 66, 69, 71
 EIP Functional Overview • 39, 45
 EIP Internal Database • 47
 EIP PCB Diagnostics • 66
 EIP Protocol • 45
 EIP Reference • 72
 EIP Server Status Data • 68
 EIP Status Data in Upper Memory • 37, 67
 Encapsulated PCCC Messages • 80
 Encapsulated PCCC Read Message • 82
 Encapsulated PCCC Write Message • 80
 Ethernet Port LEDs • 29
 EtherNet/IP Explicit Messaging Server Command
 Support • 51
 EtherNet/IP General Specifications • 46
 EXT STS Error Codes • 70

F

Forward Open Response Error Codes • 72
 From Address • 23

G

Gateway Communication Error Codes • 129
Gateway Status Data in Upper Memory • 36
General Gateway Status Data in Upper Memory • 37
General Modbus Error and Status Data • 123, 124
General Specifications • 132

H

Hardware Information • 39
How to Contact Us • 2

I

Important Installation Instructions • 3
Input/Output Error Message Status Codes • 202
Installing ProSoft Configuration Builder Software • 13

J

Jumper Settings • 12

L

LED Indicators • 27
Local STS Error Codes • 69

M

Main Gateway LEDs • 28
Mapping Data in Module Memory • 21, 36, 48, 94, 114,
123, 124, 126, 128, 136, 144, 151, 167, 179, 201
Master Port
 Command List Errors • 126, 127
 Modbus Slave List Status • 128
MBS Command List Error Codes • 130
MBS Configuration • 115
MBS Diagnostics • 114, 123
MBS Error Codes • 129
MBS Functional Overview • 111
MBS Internal Database • 111, 113
MBS Master Configuration Parameters • 118
MBS PCB Diagnostics • 123
MBS Port [x] Commands • 118, 120
MBS Protocol • 111
MBS Reference • 130
MBS Slave Configuration Parameters • 119
MBS Status Data in Upper Memory • 37, 123
MBTCP Client Command List Error Data • 106
MBTCP Client Specific Errors • 107
MBTCP Client Status Data • 105
MBTCP Command List Error Codes • 108
MBTCP Communication Error Codes • 107
MBTCP Configuration • 97
MBTCP Error Codes • 107
MBTCP Functional Overview • 91
MBTCP General Specifications • 92
MBTCP Internal Database • 91, 93
MBTCP PCB Diagnostics • 104
MBTCP Protocol • 91
MBTCP Reference • 108
MBTCP Server Status Data • 104

MBTCP Status Data in Upper Memory • 37, 104
Messaging from a ControlLogix or CompactLogix
 Processor • 80
Messaging from a PLC5 • 76
Messaging from a SLC 5/05 • 72
MG • 80
Modbus Master/Slave Port Specifications • 112
Modbus Message Routing
 Port 2001 • 97
Modbus Port Access to Database • 115
Modbus Serial Specifications • 112
Modbus TCP/IP Client • 92
Modbus TCP/IP Client Access to Database • 95
Modbus TCP/IP Server • 92
Mounting the Gateway on a DIN-rail • 11
MSG Instruction Type - CIP • 50
MSG Instruction Type - PCCC • 50
Multiple Server Access to Database • 95
Multiple Server Access to EIP Database • 48

N

Network Diagnostics • 48, 66, 94, 104
Notes on Addressing in S7 Processors • 156, 163

O

Overview • 9

P

Package Contents - PLX3x • 10
PCCC Response Error Codes • 72
PD • 79
PLC-5 Command Set Functions • 51
PLC5 Processor Specifics • 76
PLC5 Read Commands • 77
PLC-5 Sub-Element Fields • 79
PLC5 Write Commands • 76
PND Configuration • 179
PND Diagnostics • 179, 201
PND Functional Overview • 177
PND General Specifications • 177
PND Internal Database • 178
PND PCB Diagnostics • 201
PND Performance • 203
PND Protocol • 177
PND Status Data in Upper Memory • 37, 201
Port 1 Command Error List Layout • 127
Port 1 General Modbus Error and Status Layout • 124
Port 1 Slave List Status Layout • 128
Printing a Configuration File • 20
Protocol-Specific Status Data in Upper Memory • 37

R

Receive Data • 133, 139
Receive-Only Mode • 136
Register Count • 23
Register Session Response Error Codes • 71
Remote STS Error Codes • 69
Renaming PCB Objects • 20

RS-232 - DTE to DCE Modem Connection • 42
RS-232 - Null Modem (DTE without Hardware
Handshaking) • 41
RS-422 Interface Connections • 42
RS-485 Interface Connection • 43

S

SD Card • 12
Serial Port Cables (for Gateways with Serial Ports) •
40
Serial Port LEDs (for Gateways with Serial Ports) • 29
Serial Port Specifications • 40, 41
Setting a Temporary IP Address in the Gateway • 15
Setting Up the Project • 16, 18
SIE Client Access to Database • 152
SIE Commands Supported by Siemens Devices • 157
SIE Configuration • 153
SIE CPU1212C • 172
SIE CPU224XP • 174
SIE CPU315-2 DP • 170
SIE Diagnostics • 151, 166
SIE Error Codes • 168, 169
SIE Functional Overview • 149
SIE Gateway Internal Database • 150
SIE General Specifications • 150
SIE Maximum Register Counts • 155
SIE Module Communication Error Codes • 168
SIE PCB Diagnostics • 166
SIE Protocol • 149
SIE Reference • 170
SIE S3-700 Supported Commands • 157
SIE S7-1200 Supported Commands • 161
SIE S7-200 Supported Commands • 160
SIE Status Data in Upper Memory • 37, 167
Slave Port
 General Port State and ComState Status • 125
SLC and MicroLogix Specifics • 72
SLC File Types • 75
SLC5/05 Read Commands • 74
SLC5/05 Write Commands • 72
SLC-500 Command Set Functions • 51
Standard Modbus Exception Code Errors • 107, 129
Start Here • 9
Step 7 Configuration • 184
Support, Service & Warranty • 205
Supported Function Codes • 109
Swap Code • 23
System Requirements • 10

T

TCP/IP Interface Error Codes • 71
Termination of Received Data • 141
Timer / Counter • 79
To Address • 23
Transmit Data • 134, 139
Transmit-Only Mode • 137
Transmit-Receive Mode • 137

U

Uploading the Project from the Gateway • 25
Using Diagnostics in ProSoft Configuration Builder •
29, 33, 34
Using ProSoft Configuration Builder • 15
Using the Data Analyzer (Serial Protocols Only) • 34

W

Warranty Information • 207

Y

Your Feedback Please • 2