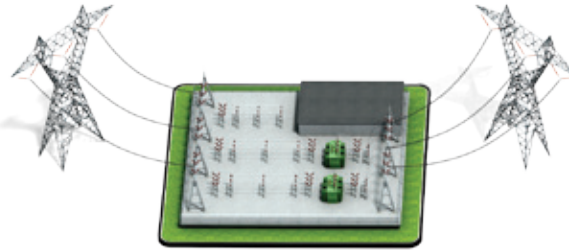

UR & UR^{Plus} Market Offerings

Generation

G60

Medium to Large Generators

The G60 provides comprehensive primary and backup protection for medium and large generators, including large steam and combustion turbines, combined-cycle generators and multi-circuit hydro units. The G60 includes advanced automation and communication capabilities, extensive I/O options, and powerful fault recording features that simplify postmortem analysis and minimize generator downtime.

G30

Combined Generator & Transformer Protection

The G30 is a flexible system that can be used on small and medium generators, generator and step-up transformer arrangements or backup protection of large generators. Similar to the G60, the G30 also offers comprehensive protection and monitoring elements.

Transmission & Distribution

D90^{Plus}

Sub-Cycle Distance Protection

The D90^{Plus} is ideally suited for application on transmission lines where fast fault detection and small breaker failure margin are required. The D90^{Plus} allows transmission limits to be maintained or even increased while respecting the transient stability limits of the power system.

D60

Fully Featured Distance Protection

The D60 is the ideal solution for providing reliable and secure primary and backup protection of transmission lines supporting: series compensation, teleprotection schemes, five mho or quad distance zones, single or three-pole tripping, breaker-and-half with independent current inputs, phasor measurement units (PMUs), and more.

D30

Backup Distance Protection

The D30 is the cost-effective choice for the primary protection of sub-transmission systems or backup protection of transmission systems. Using FlexLogic™ elements, basic pilot schemes can be programmed. The D30 has complementary protection, control, communication, monitoring and metering functions that meet the toughest requirements of the market.

L90

Complete Line Protection

The L90 is a fast and powerful high-end phase-segregated line current differential and complete distance protection system, suitable for MV cables, two or three terminal transmission lines having breaker-and-half and single or three-pole tripping schemes.

L60

Line Phase Comparison Protection

The L60 is an extremely fast line phase comparison system, suitable for two or three terminal transmission lines. This system is able to operate using power line carrier or fiber optic communications.

L30

Sub-Transmission Line Current Differential Protection

The L30 is a cost-effective phase-segregated line current differential system intended to provide primary protection for MV cables and two/three-terminal sub-transmission lines or backup protection to transmission lines.

B90

Low Impedance Busbar Protection

The B90 is an advanced low-impedance differential protection system that is intended to cover applications ranging from small to large substations, having either single or complex-split busbar schemes. It is able to support busbars with up to 24 breakers, and 4 single phase differential zones.

B30

Low Impedance Busbar Protection

The B30 is a cost-effective, advanced protection system that fits busbars with up to 6 circuits and two protection zones. The B30 provides advanced elements like CT trouble, directional and CT saturation, breaker failure and voltage supervision that make the B30 an extremely fast and secure busbar protection system.

B95^{Plus}

Distributed Busbar Protection System

The B95^{Plus} is GE's distributed busbar solution that can be applied to any kind of busbar configuration and uses standard IEC 61850 protocol to connect to the bay units. The B95^{Plus} delivers comprehensive and reliable protection for busbar applications with up to 24 feeders.

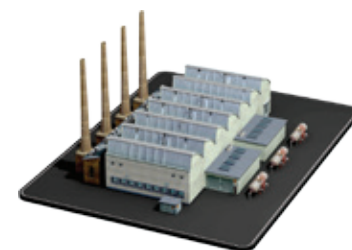
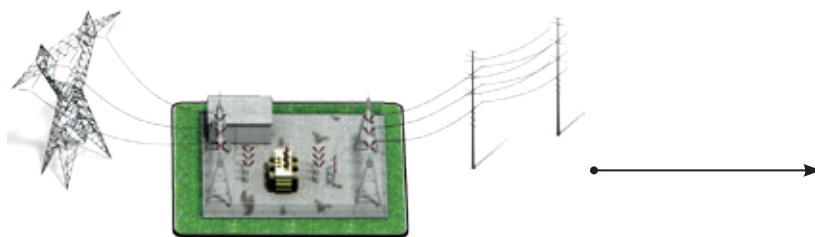

Transmission & Distribution (Continued)

F60

Feeder Protection with Hi-Z Fault Detection

The F60 provides comprehensive feeder protection, control, advanced communications, monitoring and metering in an integrated, economical, and compact package and more.

F35

Multiple Feeder Protection

The F35 is a cost-effective device for primary feeder protection. F35's modular design allows customers to protect groups of feeders as follows: independent current and voltage inputs, independent current and common voltage inputs or independent current inputs only.

C70

Capacitor Bank Protection

The C70 is an integrated protection, control, and monitoring device for shunt capacitor banks. The current and voltage-based protection functions are designed to provide sensitive protection for grounded, ungrounded single and parallel capacitor banks and banks with taps.

T60

Medium to Large Transformers

The T60 is a fully featured transformer protection system suitable for power transformers of any size that require current differential function. The T60 provides automatic or user-definable magnitude reference winding selection for CT ratio matching, and performs automatic phase shift compensation for all types of transformer winding connections.

T35

Basic Transformer Protection, Multiple CTs

The T35 is a basic transformer protection system capable of protecting combined main power transformers and up to five feeders downstream. The T35 provides automatic or user-definable magnitude reference winding selection for CT ratio matching, automatic phase shift compensation and allows users to enable removal of the zero-sequence current even for delta connected transformer windings.

C90^{Plus}

Breaker Automation and Controller

The C90^{Plus} is a powerful logic controller designed to be used in substation environments and for the unique automation requirements of industrial and utility power systems. The C90^{Plus} provides unmatched logic processing ability combined with a powerful math engine with deterministic execution of logic equations regardless of the configuration of the number of lines of logic.

C60

Breaker Controller

The C60 is a substation hardened controller that provides a complete integrated package for the protection, control, and monitoring of circuit breakers, supporting dual-breaker busbar configurations, such as breaker-and-half or ring bus schemes.

C30

I/O Logic Controller

The C30 is designed to perform substation control logic that can also expand the I/O capability of protection devices and replace existing Sequence of Events (SOE) recorders.

M60

Motor Protection

The M60 offers comprehensive protection and control solutions for large-sized three-phase motors. The M60 provides superior protection, control, and diagnostics that includes thermal model with RTD and current unbalance biasing, stator differential, reverse and low forward power, external RRTD module, two-speed motors, reduced voltage starting, broken rotor bar detection, and more.

N60

Network Stability and Synchrophasor Measurement

The N60 is intended to be used on load shedding, remedial action, special protection and wide area monitoring and control schemes. Like no one device before, the N60 shares real-time operational data to remote N60s so the system can generate intelligent decisions to maintain power system operation.

Overview

The Universal Relay (UR) is a family of leading edge protection and control products built on a common modular platform. All UR products feature high-performance protection, expandable I/O options, integrated monitoring and metering, high-speed communications, and extensive programming and configuration capabilities. The UR forms the basis of simplified power management for the protection of critical assets, either as a stand-alone device or within an overall power automation system.

The UR is managed and programmed through EnerVista Launchpad. This powerful software package, which is included with each relay, not only allows the setpoints of the relay to be programmed, but also provides the capability to manage setpoint files, automatically access the latest versions of firmware/documentation and provide a window into the substation automation system.

The UR can be supplied in a variety of configurations and is available as a 19-inch rack horizontal mount unit or a reduced size (¾) vertical mount unit. The UR consists of the following modules: power supply, CPU, CT/VT input, digital input/output, transducer input/output, inter-relay communications, communication switch and IEC Process Bus. All hardware modules and software options can be specified at the time of ordering.

Protection and Control

The UR incorporates the most complete and unique protection algorithms to provide unparalleled security and system uptime. The UR selector guide (in the following pages) lists all the protection elements found in each relay.

To support the protection and control functions of the UR, various types and forms of I/O are available (specific capabilities are model dependent). Supported I/Os include:

CTs and VTs

Up to 24 analog current transformer (CT) and voltage transformer (VT) signals can be configured to monitor AC power lines. Both 1 A and 5 A CTs are supported. Special function modules are available including: a CT module with sensitive ground input to provide ground fault protection on high-impedance grounded systems, and a high-impedance fault detection module that provides fast and reliable detection of faults caused by downed conductors.

UR - Protection, Metering, Monitoring and Control

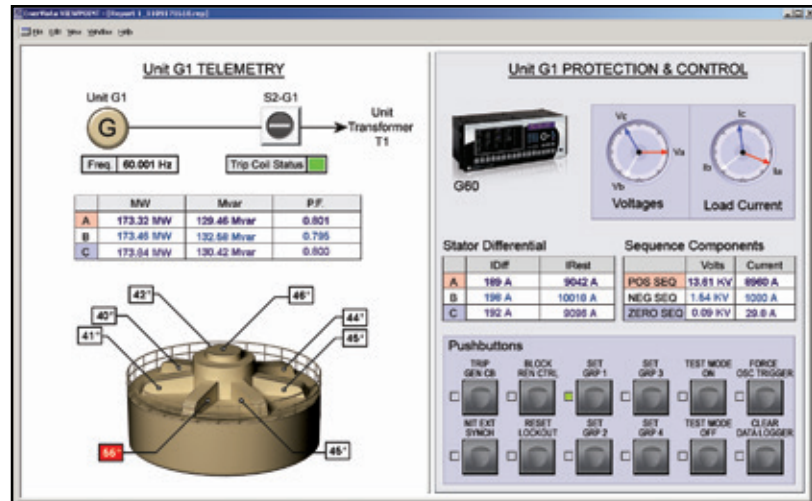

The UR is the single point for protection, control, metering, and monitoring in one integrated device that can easily be connected directly into DCS or SCADA monitoring and control systems like Viewpoint Monitoring as shown.

Digital I/O

Up to 96 contact inputs (with utility voltage rating up to 250V), and up to 64 contact outputs, are available and can be used to monitor and control a wide range of auxiliary equipment found within a substation or other protection application. Types of digital I/O cards include trip-rated Form-A, Form-C, Fast Form-C, latching and Solid State Relay (SSR), with or without DC voltage, current monitoring and isolated inputs (with auto burnish feature). Mechanically latching outputs can be used to develop secure interlocking applications and replace mechanical switches and lockout relays. Form-A digital outputs have activation speeds of less than 4ms and both wet and dry contacts are supported.

Solid state output modules with high current breaking capability, fast tripping and reset time are ideal for direct tripping applications.

Transducer I/O

RTDs and DCmA cards are available to monitor system parameters, such as temperature, vibration, pressure, wind speed, and flow. Analog outputs can be used for hardwired connections from the controller to a SCADA system, to a programmable logic controller (PLC), or to other user interface devices (eg. panel display).

Advanced Automation

The UR incorporates advanced automation features including powerful FlexLogic programmable logic, communication, and

SCADA capabilities that far surpass what is found in the average protection relay. Each UR can be seamlessly integrated with other UR relays for complete system protection and control.

FlexLogic

FlexLogic is the powerful UR-platform programming logic engine that provides the ability to create customized protection and control schemes, minimizing the need and associated costs of, auxiliary components and wiring. Using FlexLogic, the UR can be programmed to provide the required tripping logic along with custom scheme logic for breaker control (including interlocking with external synchronizers), transfer tripping schemes for remote breakers and dynamic setting group changes.

Scalable Hardware

The UR is available with a multitude of I/O configurations to suit the most demanding application needs. The expandable modular design allows for easy configuration and future upgrades.

- Multiple CT/VT configurations allow for the implementation of many different schemes, including concurrent split-phase and differential protection
- Flexible, modular I/O covering a broad range of input signals and tripping schemes with trip rated Form-A, SSR, Form-C and mechanically latched relays
- Inter-relay communications module that enables the sharing of digital status and

DFR – SUMMARY		
	Ready to Capture	Memory Available
Fault Report	●	●
Transient Recorder	●	●
Disturbance Recorder	●	●
Records	Latest	Total
Events	Mar 05 2009 12:23:23:637727	431
Faults	Mar 05 2009 12:23:20:735543	1
Transients	Mar 05 2009 12:23:20:721634	1
Disturbances	Mar 04 2009 02:47:12:346789	3
Summary	SOE	Fault Reports
		Transient
		Disturbance

Digital fault recorder summary with the latest information on the events, faults, transients and disturbances.

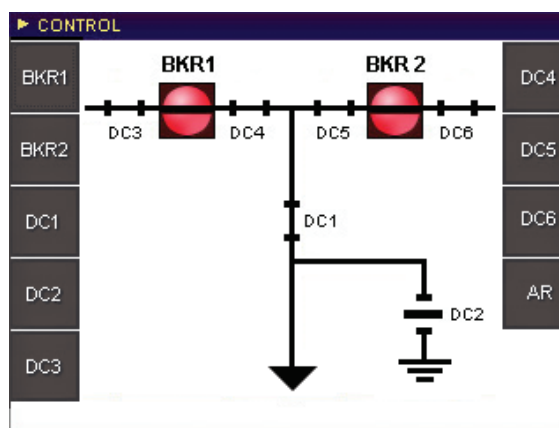

Control screen for the preconfigured bay with breaker & disconnect control in multiple pages using dedicated pushbuttons in the front panel.

analog values between UR relays for control, fast tripping or teleprotection applications

- Types of digital outputs include trip-rated Form-A and SSR mechanically latching, and Form-C outputs
- Form-A and SSR outputs available with optional circuit continuity monitoring and current detection to verify continuity and health of the associated circuitry
- IEC 61850 Process Bus delivering advanced protection and control capabilities while providing significant savings on the total life cost of electrical substations
- RTDs and DCmA inputs are available to monitor equipment parameters such as temperature and pressure

Monitoring and Metering

The UR includes high accuracy metering and recording for all AC signals. Voltage, current, and power metering are built into the relay as a standard feature. Current and voltage parameters are available as total RMS magnitude, and as fundamental frequency magnitude and angle.

Fault and Disturbance Recording

The advanced disturbance and event recording features within the UR can significantly reduce the time needed for postmortem analysis of power system events and the creation of regulatory reports. Recording functions include:

- Sequence of Event (SOE)
 - 1024 time stamped events (UR Relays)
 - 8192 time stamped events (URPlus)
- Oscillography
 - 64 digital & up to 40 analog channels
 - Events with up to 45s length

- Data Logger and Disturbance Recording
 - 16 channels up to 1 sample/cycle/channel
- Fault Reports
 - Powerful summary report of pre-fault and fault values

The very high sampling rate and large amounts of storage space available for data recording in the UR allows for the capture of complex events and can eliminate the need for installing costly stand-alone recording equipment.

Advanced Device Health Diagnostics

The UR performs comprehensive device health diagnostic tests at startup and continuously during run-time to test its own major functions and critical hardware. These diagnostic tests monitor for conditions that could impact security and availability of protection, and present device status via SCADA communications and front panel display. Providing continuous monitoring and early detection of possible issues help improve system uptime.

- Comprehensive device health diagnostic performed at startup
- Monitors the CT/VT input circuitry to validate the integrity of all signals
- Monitors internal DC voltage levels that allows for proactive maintenance and increased uptime

PMU - Synchrophasors

With the ability of having up to 6 PMU elements in one device, UR devices provide simultaneous data streams of up to four different clients.

UR devices exceed the IEEE C37.118 (2011) requirements for Total Vector Error (TVE) less than 1% over a range of 40Hz to 70Hz, and are able to measure and report synchrophasors

over a frequency range from 30Hz to 90Hz with little effect on TVE.

A special feature of the synchrophasor implementation is the ability to apply magnitude and phase angle correction on a per-phase basis for known CT and PT magnitude and phase errors. Selected UR devices can apply a phase correction on each phase of up to $\pm 5^\circ$ in increments of 0.05° . They also provide the ability to adjust for delta-wye phase angle shifts or polarity reversal in the synchrophasor reporting of the voltage and current sequence components.

UR devices can stream PMU data through any of its three Ethernet ports using either IEEE C37.118 or IEC 61850-90-5 data formats. When streaming PMU data through a single port, a failover function can automatically switch the transmission over another Ethernet port.

Selected UR devices also support up to 16 user-definable command outputs via the command frame defined in the IEEE C37.118 standard.

PMU recording

UR devices include high accuracy metering and recording for all AC signals. Voltage, current, frequency, power and energy and demand metering are built into the relay as a standard feature. Current and voltage parameters are available as total RMS magnitude, and as fundamental frequency magnitude and angle. UR devices have 12MB of synchrophasor recording memory with multiple recording and triggering options. The PMU recorder can be triggered by an over/under frequency, over/under voltage, overcurrent, overpower, rate of change of frequency condition, or by a user-specified condition, freely configured through FlexLogic. The PMU status flag shows which of those functions triggered the PMU recorder.

Monitor Multiple Power Circuits

Selected UR devices can monitor from one up to six three-phase power circuits and can be configured to simultaneously provide as many as 6 PMUs. Other configurations are: three power circuits with independent currents and voltages, four power circuits with independent currents and two common voltages, five power circuits with independent current and one common voltage. UR devices provide metering of many power system quantities including active, reactive and apparent power on a per-phase, and three-phase basis, true RMS value, phasors and symmetrical components of currents, and voltages, power factor, and frequency. Frequency can be measured independently and simultaneously from up to six different signals including currents if needed. UR devices allow for the creation and processing of virtual sums of currents through its user configuration mechanism of "signal sources", and can also sum analog values through its FlexMath elements.

Communications

The UR provides advanced communications technologies for remote data and engineering access, making it easy and flexible to use and integrate into new and existing infrastructures. Direct support for fiber optic Ethernet provides high-bandwidth communications allowing for low-latency controls and high-speed file transfers of relay fault and event record information. The available redundant Ethernet option provides the means to create fault tolerant communication architectures in an easy, cost-effective manner without the need for intermediary communication hardware.

The UR supports the most popular industry standard protocols enabling easy, direct integration into DCS and SCADA systems.

- IEC 61850 with 61850-90-5 support
- DNP 3.0 (serial & TCP/IP)
- Ethernet Global Data (EGD)
- IEC 60870-5-103 and IEC 60870-5-104
- Modbus RTU, Modbus TCP/IP
- HTTP, TFTP
- SNTP and IEEE 1588 for time synchronization
- PRP as per IEC 62439-3

Purpose Specific LAN

The available three independent Ethernet ports enable users to segregate heavy traffic (eg. synchrophasors) from mission critical services (eg. GOOSE), as a way to eliminate potential latency effects.

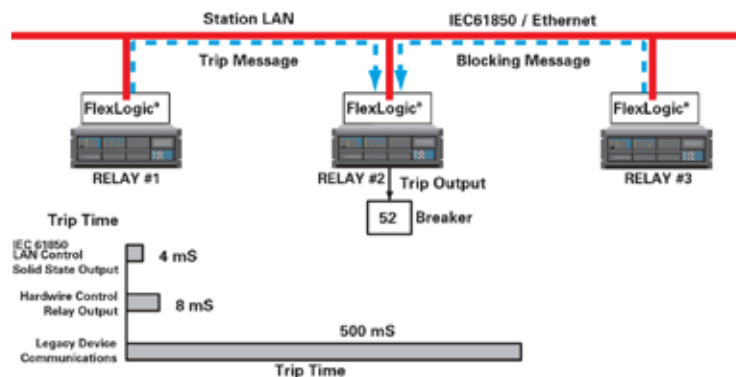

IEC 61850 protocol enables high-speed trip and control via the substation LAN without complex fixed wiring to many auxiliary devices.

Precision Time Protocol - IEEE 1588

UR devices support the IEEE 1588 v2 (2012) time synchronization protocol that enables time synchronization via the substation LAN with no sacrifice on time accuracy (1 μ s). IEEE 1588 removes the dedicated IRIG-B wiring and repeaters used for time synchronization that are traditionally used in substations.

UR Switch Module

In addition to providing high-speed connectivity directly to the UR, the UR Switch Module provides an additional 4 fiber Ethernet ports, for connection to other relays in the system as well as upstream connectivity. It also provides 2 RJ45 copper Ethernet ports which can be used to connect local devices such as PCs, meters, or virtually anything else in the system.

The UR Switch Module provides a simple way to add fully-managed Ethernet networking to your relays and devices without the need for additional hardware or a dedicated communications cabinet.

The UR Switch Module includes all the management and features that come with all MultiLink managed switches, and can be easily integrated into a network that has other Ethernet switches.

When used in a ring topology with other UR switch modules or MultiLink switches, the UR Switch Module can be configured to use MultiLink's Smart RSTP feature to provide industry-leading network recovery for ring topologies, at a speed of less than 5ms per switch.

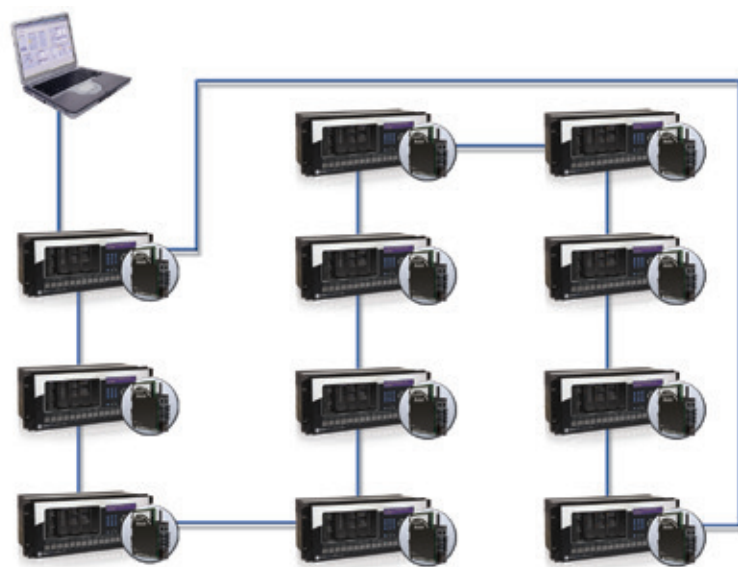

The UR Switch Module is a fully-managed Ethernet switch with a modular form factor. It can be placed directly into a GE Multilin UR to provide Ethernet connectivity to the relay as well as other Ethernet-enabled devices.

Interoperability with Embedded IEC 61850

Use the UR with integrated IEC 61850 to lower costs associated with system protection, control and automation. GE Digital Energy's leadership in IEC 61850 comes from thousands of installed devices and follows on extensive development experience with UCA 2.0.

- Backup wired signals or replace expensive copper wiring between devices with direct transfer of data using GOOSE messaging
- Configure GE systems based on IEC 61850 and also monitor and troubleshoot them in real-time with EnerVista Viewpoint Engineer
- Multicast IEEE C37.118 synchrophasor data between PMU and PDC devices using IEC 61850-90-5

LAN Redundancy

Substation LAN redundancy has been traditionally accomplished by reconfiguring the active network topology in case of failure. Regardless of the type of LAN architecture (tree, mesh, etc), reconfiguring the active LAN requires time to switchover, during which the LAN is unavailable. UR devices deliver redundancy as specified by PRP-IEC 62439-3,

which eliminates the dependency on LAN reconfiguration and the associated switchover time. The UR becomes a dual attached node that transmits data packets over both main and redundant networks simultaneously, so in case of failure, one of the data packets will reach the receiving device with no time delay.

Direct I/O Messaging

Direct I/O allows for the sharing of analog or high-speed digital information between multiple UR relays via direct back-to-back connections or multiplexed through a standard DS0 multiplexer channel bank. Regardless of the connection method, direct I/O provides continuous real-time channel monitoring that supplies diagnostics information on channel health. Direct I/O provides superior relay-to-relay communications that can be used in advanced interlocking, generation rejection and other special protection schemes.

- Communication with up to 16 UR relays in single or redundant rings rather than strictly limited to simplistic point-to-point configurations between two devices
- Connect to standard DS0 channel banks through standard RS422, G.703 or IEEE C37.94 interfaces or via direct fiber optic connections
- No external or handheld tester required to provide channel diagnostic information

Multi-Language

UR devices support multiple languages: English, French, Russian, Chinese, Turkish and German. These language options are available on the front panel, in the EnerVista setup software, and in the product manuals. Easily switch between English and an additional language on the local displays without uploading new firmware.

HardFiber IEC 61850 Process Bus

The HardFiber Process Bus System represents a true breakthrough in the installation and ownership of protection and control systems, by reducing the overall labor required for substation design, construction, and testing. This innovative solution addresses the three key issues driving the labor required for protection and control design, construction and testing:

- Every substation is unique, making design and drafting a one-off solution for every station
- Miles of copper wires need to be pulled, spliced and terminated

- Time-consuming testing and troubleshooting of thousands of connections must be performed by skilled personnel

The HardFiber Process Bus System was designed to address these challenges and reduce the overall labor associated with the tasks of designing, documenting, installing and testing protection and control systems. By specifically targeting copper wiring and all of the labor it requires, the HardFiber Process Bus System allows for greater utilization and optimization of resources with the ultimate goal of reducing the total life cost (TLC) for protection and control.

Cyber Security - CyberSentry UR

CyberSentry enables UR devices to deliver full cyber security features that help customers to comply with NERC CIP and NIST[®]IR 7628 cyber security requirements through supporting the following core features:

Password Complexity

Supporting up to 20 alpha- numeric or special characters, UR passwords exceed NERC CIP requirements for password complexity. Individual passwords per role are available.

AAA Server Support (Radius)

Enables integration with centrally managed authentication and accounting of all user activities and uses modern industry best practices and standards that meet and exceed NERC CIP requirements for authentication and password management.

Role Based Access Control (RBAC)

Efficiently administrate users and roles within UR devices. The new and advanced access functions allow users to configure up to eight roles for up to eight configurable users with independent passwords. The standard "Remote Authentication Dial In User Service" (Radius) is used for authentication.

Event Recorder (Syslog for SEM)

Capture all cyber security related events within a SOE element (login, logout, invalid password attempts, remote/local access, user in session, settings change, FW update, etc), and then serve and classify data by security level using standard Syslog data format. This enables UR devices to integrate with established SEM (Security Event Management) systems.

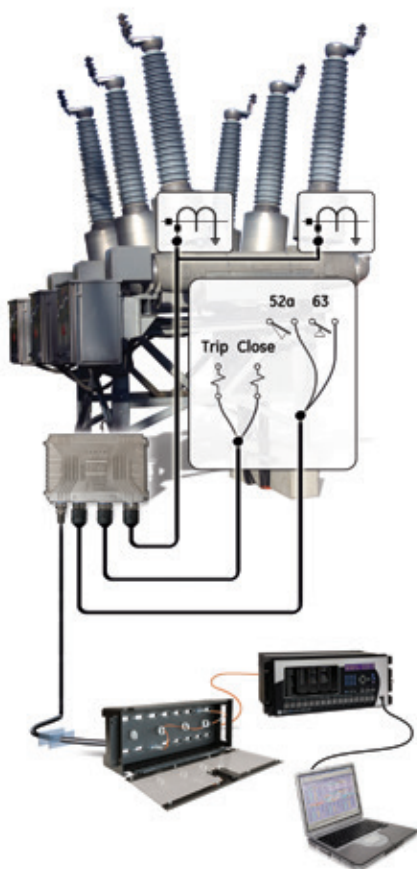

IEC 61850 protocol enables high-speed trip and control via the substation LAN without complex fixed wiring to many auxiliary devices.

EnerVista Software

The EnerVista suite is an industry-leading set of software programs that simplifies every aspect of using the UR. The EnerVista suite provides all the tools to monitor the status of the protected asset, maintain the relay, and integrate information measured by the UR into DCS or SCADA monitoring systems. Convenient COMTRADE and SOE viewers are an integral part of the UR setup software included with every UR relay, to carry out postmortem event analysis and ensure proper protection system operation.

EnerVista Launchpad

EnerVista Launchpad is a powerful software package that provides users with all of the setup and support tools needed for configuring and maintaining GE Multilin products. The setup software within Launchpad allows for the configuration of devices in real-time by communicating using serial, Ethernet, or modem connections, or offline by creating setting files to be sent to devices at a later time.

Included in Launchpad is a document archiving and management system that ensures critical documentation is up-to-date and available when needed. Documents made available include:

- Manuals
- Application Notes and Support Documents
- Guideform Specifications
- Brochures
- Wiring Diagrams
- FAQ's
- Service Bulletins

Viewpoint Monitoring

Viewpoint Monitoring is a simple-to-use and full-featured monitoring and data recording software package for small systems. Similar to small SCADA systems, Viewpoint Monitoring provides a complete HMI package with the following functionality:

- Plug-&-Play Device Monitoring
- System Single-Line Monitoring & Control
- Annunciator Alarm Screens
- Trending Reports
- Automatic Event Retrieval
- Automatic Waveform Retrieval

Viewpoint UR Engineer

Viewpoint UR Engineer is a set of powerful tools that allows the configuration and testing of GE relays at a system level in an easy-to-use graphical drag-and-drop environment. Viewpoint UR Engineer provides the following configuration and commissioning utilities:

- Graphical Logic Designer (Substation)
- Graphical System Designer
- Graphical Logic Monitor
- Graphical System Monitor (Substation)
- IEC 61850 Configurator

Viewpoint Maintenance

Viewpoint Maintenance provides tools that will create reports on the operating status of the relay, simplify the steps to download fault and event data, and reduce the work required for cyber security compliance audits. Tools available in Viewpoint Maintenance include:

- Settings Security Audit Report
- Device Health Report
- Single-Click Fault Data Retrieval

EnerVista Integrator

EnerVista Integrator is a toolkit that allows seamless integration of Multilin devices into new or existing automation systems. Included in EnerVista Integrator is:

- OPC/DDE Server
- GE Multilin Drivers
- Automatic Event Retrieval
- Automatic Waveform Retrieval

User Interface

The UR front panel provides extensive local HMI capabilities. The local display is used for monitoring, status messaging, fault diagnosis, and device configuration. User-configurable messages that combine text with live data can be displayed when user-defined conditions are met. Configurable LEDs allows status and alarm signaling (50 LEDs).

The UR^{Plus} has a colorful, graphical HMI that allows users to have local monitoring of status, values and control functionality.

The alarm annunciator panel provides the configuration of up to 256 signals (alarms and status) with full text description.

Power System Troubleshooting

The UR contains many tools and reports that simplify and reduce the amount of time required for troubleshooting power system events, increase uptime and reduce loss of production.

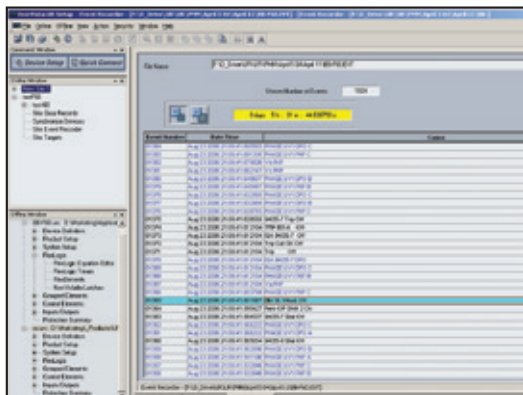

Record the operation of the internal UR elements and external connected devices with 1ms time-stamped accuracy to identify the Sequence of Operation of station devices during faults and disturbances.

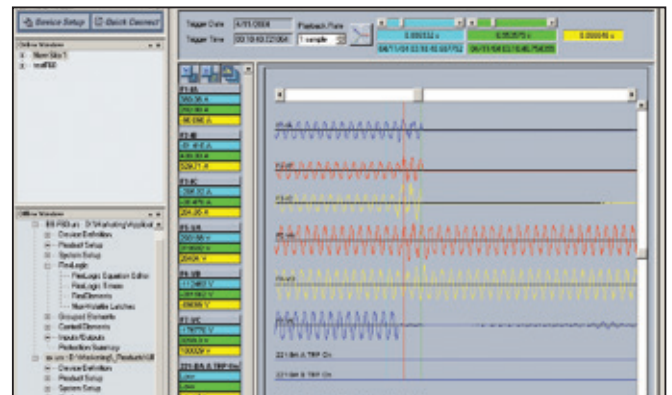

Analyze faults and disturbances using both analog and digital power system quantities.

UR^{Plus} Front Panel with Large Color Display and Annunciator Panel

Digital Alarm Annunciator

- 256 customizable alarms in multiple pages
- Eliminates the need for separate annunciator

Intuitive HMI

- Customizable bay diagrams for various applications
- Local control and status indication of breakers & disconnect switches
- Local/remote control (20 programmable buttons)
- Fault, event, disturbance and transient reports

Advanced Control

- Customizable bay diagrams for various applications
- Local control and status indication of breakers & disconnect switches
- Local/remote control
- Fault, event, disturbance and transient reports



Advanced Automation Controller

- Built-in programmable logic engine
- Advanced math, Boolean and control operations

Advanced Communications Capabilities

- Up to three Ethernet ports
- IEC 61850, DNP 3.0, Modbus TCP/IP, IEC 60870-5-104 protocols
- IEEE C37.118 synchrophasors over Ethernet

Advanced Recorders

- Eliminate the need for stand-alone disturbance recorders
- 128 samples/cycle, 1 min duration transient recorder
- Separate dynamic disturbance recorder for recording long term events
- Synchrophasors PMU recording

Front USB Port

- High-speed local data transfer

UR^{Plus} Dimensions

HORIZONTAL FRONT VIEW

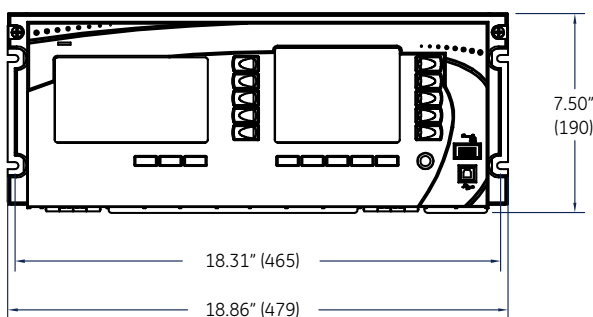

HORIZONTAL TOP VIEW

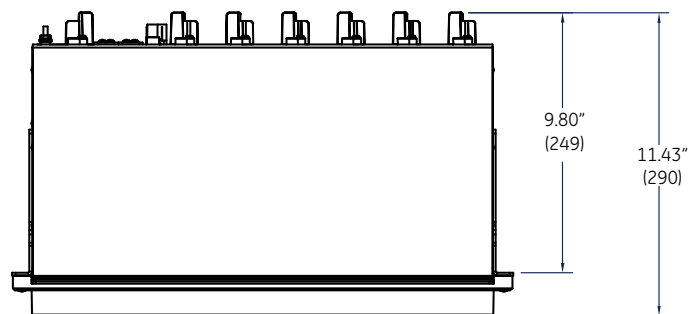

UR Enhanced Front Panel with Large Display, Customizable LED Annunciator, and User-Programmable Pushbuttons

Family Overview



UR Horizontal Dimensions

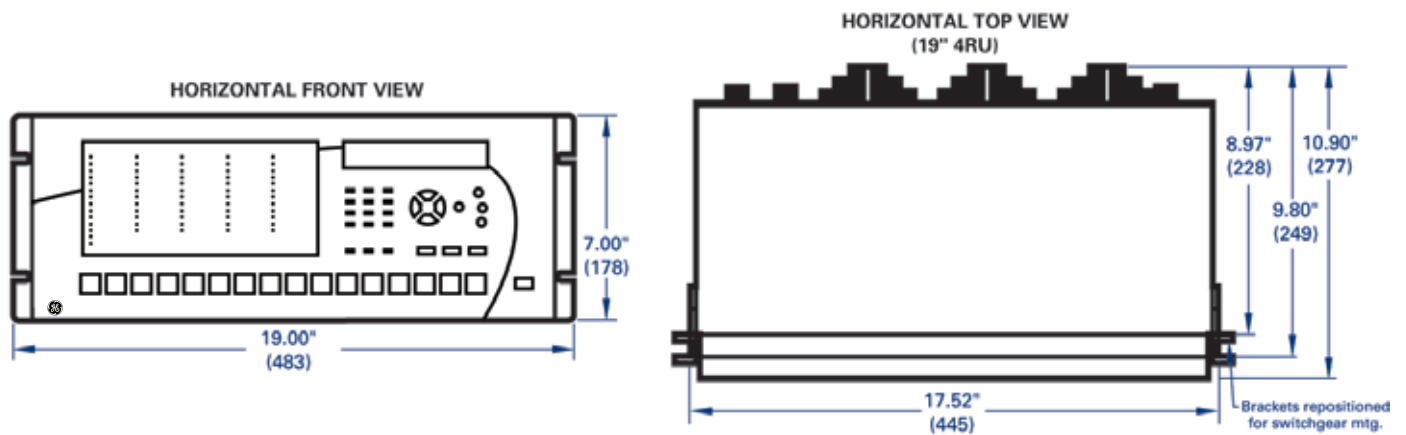

UR Enhanced Front Panel - Vertical Faceplate



- Secure Locking
- Large LCD Display
- Bright, Easy Labeling, LED Annunciator
- Complete Keypad and 3 User Pushbuttons
- Local RS232 Port
- Optional 6 User-Programmable Pushbuttons

UR Vertical Dimensions

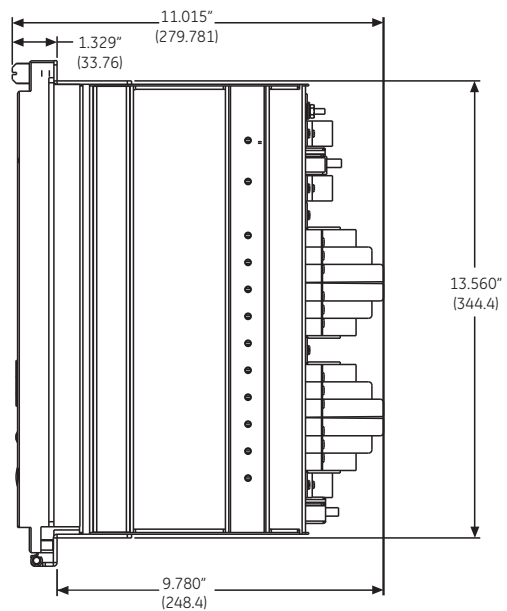
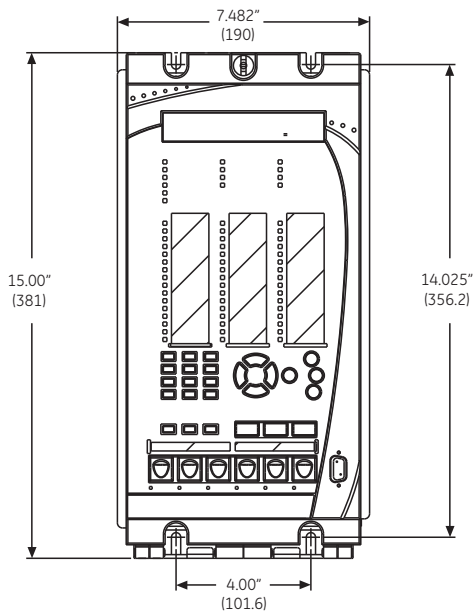

Features F35 F60 G30 G60 L30 L60 L90 M60 N60 T35 T60

Protection	F35	F60	G30	G60	L30	L60	L90	M60	N60	T35	T60
Disturbance Detector		•			•	•	•		•		
Mho Distance, Phase (No. of Zones)				3		3	5				5
Mho Distance, Ground or Neutral Phase (No. of Zones)						3	3				5
Quadrilateral Distance, Phase (No. of Zones)						3	3				5
Quadrilateral Distance, Ground or Neutral (No. of Zones)						3	3				5
Permissive Pilot Logic							•				
Sub-Cycle Distance											
Overexcitation Protection (V/Hz)			•	•							•
Synchronism Check or Synchronizing		•	•	•	•	•	•		•		•
Undervoltage, Phase	•	•	•	•	•	•	•		•		•
Undervoltage, Auxiliary	•	•	•	•	•	•	•		•		•
Stator Ground (3rd Harmonic)			•	•							
Sensitive Directional Power		•	•	•				•	•		
Loss of Excitation - Based on Reactive Power			•	•				•			
Loss of Excitation - Based on Impedance Element			•	•							
Current Unbalance			•	•				•			
Broken Conductor Detection		•									
IOC, Negative Sequence		•			•	•	•				
TOC, Negative Sequence		•			•	•	•				
Current Directional, Negative Sequence		•	•	•		•	•				
Reverse Phase Sequence Voltage								•			
Thermal Model				•				•			•
Inadvertent/Accidental Energization			•	•							
End of Fault Protection											
Motor Mechanical Jam								•			
Motor Start Supervision								•			
Motor Acceleration Time								•			
User Programmable Curves	•	•	•	•	•	•	•	•	•	•	•
Breaker Failure	Logic	•	Logic	•	•	•	•	•	Logic	Logic	Logic
IOC, Phase	•	•	•	•	•	•	•	•	•		•
IOC, Ground	•	•	•	•	•	•	•	•			•
IOC, Neutral	•	•	•	•	•	•	•	•			•
IOC, Sensitive Ground	•	•	•	•	•	•	•	•			•
High Impedance Fault Detection		•									
TOC, Phase	•	•	•	•	•	•	•	•		•	•
TOC, Ground	•	•	•	•	•	•	•	•		•	•
TOC, Neutral	•	•	•	•	•	•	•	•		•	•
TOC, Sensitive Ground	•	•	•	•	•	•	•	•		•	•
TOC, Voltage Restrained	•	•	•	•		•	•	•		•	•
Overvoltage, Phase		•	•	•	•	•	•	•			•
Overvoltage, Auxiliary	•	•	•	•	•	•	•	•			•
Overvoltage, Neutral	•	•	•	•	•	•	•	•			•
Negative Sequence Overvoltage		•	•	•				•			
100% Stator Ground Protection			•	•							
Current Directional, Phase		•	•	•		•	•	•			•
Current Directional, Neutral		•	•	•		•	•	•			•
Current Directional, Negative Sequence		•	•	•		•	•	•			•
Power Swing Blocking				•		•	•	•			•
Out-of-Step Tripping				•		•	•	•			•
AC Reclosing (No. of Shots)	4	4			4	4	4				
Switch on to Fault (Line Pickup)						•	•				
Voltage Transformer Fuse Failure		•	•	•	•	•	•	•	•		•
Current Transformer Supervision					•	•	•				
Load Encroachment Logic		•				•	•				•
Underfrequency	•	•	•	•	•				•		•
Overfrequency		•	•	•					•		•
Anti-Islanding Protection/Frequency Rate of Change		•	•	•			•		•		•
Lockout Functionality	•	•	•	•		•	•	•	•	•	•
Bus Differential											
Line Current Differential					•		•				
Ground Differential		•	•	•	•		•				•
Stator Differential			•	•				•			
Transformer Differential			•							•	•
Line Phase Comparison						•					
Voltage Differential											
Capacitor Bank Overvoltage											
Neutral Voltage Unbalance											
Automatic Voltage Regulation											
Time of Day Control											
Instantaneous Differential										•	•
Split Phase Protection			•	•							
Line Current Differential Trip Logic							•				
CT Failure			•	•	•	•	•	•		•	•

UR Technical Specifications

PROTECTION

100% STATOR GROUND

Operating quantity: $V_{neutral_3rd}/(V_{neutral_3rd} + V_{zero_3rd})$
Pickup level: 0.000 to 0.250 pu in steps of 0.001
Dropout level: 97 to 98% of pickup
Level accuracy: ±2% of reading from 1 to 120 V
Pickup delay: 0 to 600.00 s in steps of 0.01
3rd harmonic supervision level: 0.0010 to 0.1000 pu in steps of 0.0001

Time accuracy: ±3% or ±20 ms, whichever is greater
Operate time: < 30 ms at 1.10 × Pickup at 60 Hz
ACCELERATION TIME
Acceleration current: 1.00 to 10.00 × FLA in steps of 0.01

Acceleration time: 0.00 to 180.00 s in steps of 0.01
Operating mode: Definite Time, Adaptive
ACCIDENTAL ENERGIZATION
Operating condition: Overcurrent
Arming condition: Undervoltage and/or Machine Offline

Overcurrent: 0.000 to 3.000 pu in steps of 0.001
Pickup level: 97 to 98% of pickup
Dropout level: ±0.5% of reading from 0.1 to 2.0 × CT rating
Level accuracy: ±0.5% of reading from 0.1 to 2.0 × CT rating

Undervoltage: 0.000 to 3.000 pu in steps of 0.001
Pickup level: 102 to 103% of pickup
Dropout level: ±0.5% of reading 10 to 208 V
Level accuracy: ±0.5% of reading from 10 to 208 V
Operate Time: < 30 ms at 1.10 × Pickup at 60 Hz

AUTOCLOSURE C60/D60/L90/L60

Two breakers applications
 Single- and three-pole tripping schemes
 Up to 4 reclose attempts before lockout
 Selectable reclosing mode and breaker sequence

AUTOCLOSURE F60/F35/D30

Single breaker applications, 3-pole tripping schemes
 Up to 4 reclose attempts before lockout
 Independent dead time setting before each shot
 Possibility of changing protection settings after each shot with FlexLogic.

AMP UNBALANCE

Avg and Full Load RMS: RMS
amps: I₁ and 1_2 amps: Phasor
Pickup level: 0.0 to 100.0% in steps of 0.1
Dropout level: 97 to 98% of pickup
Level accuracy: ±0.1
Pickup delay: 0.00 to 600.00 s in steps of 0.01
Reset delay: 0.00 to 600.00 s in steps of 0.01
Operate time: < 20 ms at 1.10 × pickup at 60 Hz
Timing accuracy: ±3% or ±20 ms, whichever is greater

AUXILIARY OVERVOLTAGE

Pickup level: 0.000 to 3.000 pu in steps of 0.001
Dropout level: 97 to 98% of Pickup
Level accuracy: ±0.5% of reading from 10 to 208 V
Pickup delay: 0 to 600.00 s in steps of 0.01
Reset delay: 0 to 600.00 s in steps of 0.01
Timing accuracy: ±3% of operate time or ±4 ms (whichever is greater)

AUXILIARY UNDERVOLTAGE

Pickup level: 0.000 to 3.000 pu in steps of 0.001
Dropout level: 102 to 103% of pickup
Level accuracy: ±0.5% of reading from 10 to 208 V
Curve shapes: GE IAV Inverse, Definite Time
Curve multiplier: Time Dial = 0 to 600.00 in steps of 0.01
Timing accuracy: ±3% of operate time or ±4 ms (whichever is greater)

BREAKER ARCING CURRENT

Principle: Accumulates breaker duty (I²t) and measures fault duration
Initiation: Programmable per phase from any FlexLogic operand
Compensation for auxiliary relays: 0 to 65.535 s in steps of 0.001
Alarm threshold: 0 to 50000 kA²-cycle in steps of 1
Fault duration accuracy: 0.25 of a power cycle
Availability: 1 per CT bank with a minimum of 2

PROTECTION

BREAKER FAILURE

Mode: 1-pole, 3-pole
Current supervision: phase, neutral current
Current supv. pickup: 0.001 to 30.000 pu in steps of 0.001
Current supv. dropout: 97 to 98% of pickup
Current supv. accuracy: ±0.75% of reading or ±2% of rated (whichever is greater)

0.1 to 2.0 × CT rating: ±2.5% of reading
BREAKER FLASHOVER
Acceleration: Phase current, voltage and voltage difference

Pickup level voltage: 0 to 1.500 pu in steps of 0.001
Dropout level voltage: 97 to 98% of pickup
Pickup level current: 0 to 1.500 pu in steps of 0.001
Dropout level current: 97 to 98% of pickup

Level accuracy: ±0.5% or ±0.1% of rated, whichever is greater
Pickup delay: 0 to 65.535 s in steps of 0.001
Time accuracy: ±3% or ±42 ms, whichever is greater
Operate time: < 42 ms at 1.10 × pickup at 60 Hz
BUS DIFFERENTIAL (87B)

Pickup level: 0.050 to 6.000 pu in steps of 0.001
Low slope: 15 to 100% in steps of 1
High slope: 50 to 100% in steps of 1
Low breakpoint: 1.00 to 30.00 pu in steps of 0.01
High breakpoint: 1.00 to 30.00 pu in steps of 0.01
High set level: 0.10 to 99.99 pu in steps of 0.01
Dropout level: 97 to 98% of Pickup

Level accuracy: ±0.5% of reading or ±1% of rated (whichever is greater)
>2.0 × CT rating: ±1.5% of reading
Operating time: one power system cycle (typical)
CT TROUBLE

Responding to: Differential current
Pickup level: 0.020 to 2.000 pu in steps of 0.001
Pickup delay: 1.0 to 60.0 sec. in steps of 0.1
Time Accuracy: ±3% or ±40ms, whichever is greater
Availability: 1 per zone of protection (B90)

GENERATOR UNBALANCE

Gen. nominal current: 0.000 to 1.250 pu in steps of 0.001
Stages: 2 (I₂t with linear reset and definite time)
Pickup level: 0.00 to 100.00% in steps of 0.01
Dropout level: 97 to 98% of pickup

Level accuracy: ±0.5% of reading or 1% of rated (whichever is greater)
> 2.0 × CT rating: ±1.5% of reading
Time dial (K-value): 0.00 to 100.00 s in steps of 0.01
Pickup delay: 0.0 to 1000.0 s in steps of 0.1
Reset delay: 0.0 to 1000.0 s in steps of 0.1
Time accuracy: ±3% or ±20 ms, whichever is greater
Operate time: < 50 ms at 60 Hz

GROUND DISTANCE

Characteristic: Mho (memory polarized or offset) or Quad (memory polarized or non-directional), selectable individually per zone
Reactance polarization: negative-sequence or zero-sequence current
Non-homogeneity angle: -40 to 40° in steps of 1
Number of zones: 5
Directionality: Forward, Reverse, or Non-Directional per zone

Reach (secondary W): 0.02 to 250.00 in steps of 0.01
Reach accuracy: ±5% including the effect of CVT transients up to an SIR of 30
Distance characteristic angle: 30 to 90° in steps of 1

Distance comparator limit angle: Directional supervision
Characteristic angle: 30 to 90° in steps of 1
Limit angle: 30 to 90° in steps of 1

Zero-sequence compensation
Z0/Z1 magnitude: 0.00 to 10.00 in steps of 0.01
Z0/Z1 angle: -90 to 90° in steps of 1
Zero-sequence mutual compensation
Z0M/Z1 magnitude: 0.00 to 7.00 in steps of 0.01
Z0M/Z1 angle: -90 to 90° in steps of 1

Right blinder (Quad only): Reach: 0.02 to 500 in steps of 0.01
Characteristic angle: 60 to 90° in steps of 1
Left blinder (Quad only): Reach: 0.02 to 500 in steps of 0.01
Characteristic angle: 60 to 90° in steps of 1
Time delay: 0.000 to 65.535 s in steps of 0.001

PROTECTION

Timing accuracy:

±3% or 4 ms, whichever is greater
Current supervision: neutral current (3I₀)
Level: 0.050 to 30.000 pu in steps of 0.001
Dropout: 97 to 98%
Memory duration: 5 to 25 cycles in steps of 1
Voltage supervision pickup (series compensation applications): 1 to 1.5 cycles (typical)
Operation time: 1 power cycle (typical)
Reset time: 1 power cycle (typical)

GROUND DISTANCE OPERATING TIME CURVES

The operating times are response times of a microprocessor part of the relay. See output contacts specifications for estimation of the total response time for a particular application. The operating times are average times including variables such as fault inception angle or type of a voltage source (magnetic VTs and CVTs).

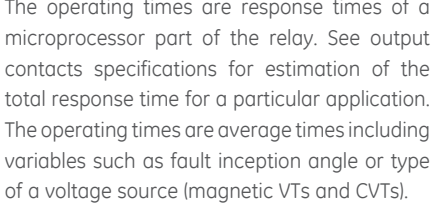

Series, tapped line, with compensation steps of 0.01 steps of 0.01

Slope # 1: 1 to 50%
Slope # 2: 1 to 70%
Breakpoint between slopes: 0.0 to 20.0 pu in steps of 0.1
DTT: Direct Transfer Trip (1 and 3 pole) remote L90

Operating Time: 1.0 to 1.5 power cycles duration
Asymmetrical channel delay compensation using GPS: asymmetry up to 10ms

LINE CURRENT DIFFERENTIAL TRIP LOGIC

87L trip: Adds security for trip decision; creates 1 and 3 pole trip logic
DTT: Engaged Direct Transfer Trip (1 and 3 pole) from remote L90
DD: Sensitive Disturbance Detector to detect fault occurrence

Stub bus protection: Security for ring bus and 1½ breaker configurations
Open pole detector: Security for sequential and evolving faults

LINE PICKUP

Phase IOC: 0.000 to 30.000 pu
Undervoltage pickup: 0.000 to 3.000 pu
Overvoltage delay: 0.000 to 65.535 s

LOAD ENCROACHMENT

Responds to: Positive-sequence quantities
Minimum voltage: 0.000 to 3.000 pu in steps of 0.001
Reach (sec. W): 0.02 to 250.00 in steps of 0.01
Impedance accuracy: ±5%
Angle: 5 to 50° in steps of 1
Angle accuracy: ±2°
Pickup delay: 0 to 65.535 s in steps of 0.001
Reset delay: 0 to 65.535 s in steps of 0.001
Time accuracy: ±3% or ±4 ms, whichever is greater
Operate time: < 30 ms at 60 Hz

LOSS OF EXCITATION

Operating condition: Positive-sequence impedance
Characteristic: 2 independent offset mho circles
Center: 0.10 to 300.0 (sec.) in steps of 0.01
Radius: 0.10 to 300.0 (sec.) in steps of 0.01
Reach accuracy: ±3%
Undervoltage supervision Level: 0.000 to 1.250 pu in steps of 0.001
Accuracy: ±0.5% of reading from 10 to 208V
Pickup delay: 0 to 65.535 s in steps of 0.001
Timing accuracy: ±3% or ±20 ms, whichever is greater
Operate time: < 50 ms

UR Technical Specifications

PROTECTION

MECHANICAL JAM

Operating condition:	Phase overcurrent
Arming condition:	Motor not starting
Pickup level:	1.00 to 10.00 × FLA in steps of 0.01
Dropout level:	97 to 98% of pickup
Level accuracy:	at 0.1 to 2.0 × CT: ±0.5% of reading
at > 2.0 × CT rating:	±1.5% of reading
Pickup delay:	0.10 to 600.00 s in steps of 0.01
Reset delay:	0.00 to 600.00 s in steps of 0.01
Time accuracy:	±3% or ±20 ms, whichever is greater

MOTOR START SUPERVISION

Maximum no. of starts:	1 to 16 in steps of 1
Monitored time interval:	1 to 300 minutes in steps of 1
Time between starts:	0 to 300 minutes in steps of 1
Restart delay:	0 to 50000 seconds in steps of 1

NEGATIVE SEQUENCE DIRECTIONAL OC

Directionality:	Co-existing forward and reverse
Polarizing:	Voltage
Polarizing voltage:	V ₂
Operating current:	I ₂ or I ₀
Level sensing:	
Zero-sequence:	$\frac{I_0}{I_2} - K \times \frac{I_1}{I_2}$
Negative-sequence:	$\frac{I_2}{I_2} - K \times \frac{I_1}{I_2}$
Restraint, K:	0.000 to 0.500 in steps of 0.001
Characteristic angle:	0 to 90° in steps of 1
Limit angle:	40 to 90° in steps of 1, independent for forward and reverse

Angle accuracy:	±2°
Offset impedance:	0.00 to 250.00W in steps of 0.01
Pickup level:	0.05 to 30.00 pu in steps of 0.01
Dropout level:	97 to 98%
Operation time:	< 16 ms at 3 × Pickup at 60 Hz

NEGATIVE SEQUENCE IOC

Current:	Phasor
Pickup level:	0.000 to 30.000 pu in steps of 0.001
Dropout level:	97 to 98% of Pickup
Level accuracy:	±0.5% of reading or ±1% of rated (whichever is greater) > 2.0 × CT rating: ±1.5% of reading
Overreach:	< 2%
Pickup delay:	0.00 to 600.00 s in steps of 0.01
Reset delay:	0.00 to 600.00 s in steps of 0.01
Operate time:	< 20 ms at 3 × Pickup at 60 Hz
Timing accuracy:	Operate at 1.5 × Pickup ±3% or ± 4 ms (whichever is greater)

NEGATIVE SEQUENCE OVERVOLTAGE

Pickup level:	0.000 to 1.250 pu in steps of 0.001
Dropout level:	97 to 98% of Pickup
Level accuracy:	±0.5% of reading from 10 to 208 V
Pickup delay:	0 to 600.00 s in steps of 0.01
Reset delay:	0 to 600.00 s in steps of 0.01
Time accuracy:	±3% or ±20 ms, whichever is greater
Operate time:	< 30 ms at 1.10 × Pickup at 60 Hz

NEGATIVE SEQUENCE TOC

Current:	Phasor
Pickup level:	0.000 to 30.000 pu in steps of 0.001
Dropout level:	97% to 98% of Pickup
Level accuracy:	±0.5% of reading or ±1% of rated (whichever is greater) from 0.1 to 2.0 × CT rating ±1.5% of reading > 2.0 × CT rating

Curve shapes:	IEEE Moderately/Very/Extremely Inverse; IEC (and BS) A/B/C and Short Inverse; GE IAC Inverse, Short/Very/Extremely Inverse; I2t; FlexCurves, (programmable); Definite Time (0.01 s base curve)
Curve multiplier (Time dial):	0.00 to 600.00 in steps of 0.01

Reset type:	Instantaneous/Timed (per IEEE) and L ear
Timing accuracy:	Operate at > 1.03 × Actual Pickup ±3.5% of operate time or ±½ cycle (whichever is greater)

NEUTRAL DIRECTIONAL OVERCURRENT

Directionality:	Co-existing forward and reverse
Polarizing:	Voltage, Current, Dual, Dual-1, Dual-V
Polarizing voltage:	V ₀ or V _X
Polarizing current:	I ₀
Operating current:	I ₀
Level sensing:	$\frac{I_0}{I_2} - K \times \frac{I_1}{I_2}$, IG
Restraint, K:	0.000 to 0.500 in steps of 0.001
Characteristic angle:	-90 to 90° in steps of 1
Limit angle:	40 to 90° in steps of 1, independent for forward and reverse

Angle accuracy:	±2°
Offset impedance:	0.00 to 250.00W in steps of 0.01
Pickup level:	0.05 to 30.00 pu in steps of 0.01
Dropout level:	97 to 98%
Operation time:	< 16 ms at 3 × Pickup at 60 Hz

NEUTRAL OVERVOLTAGE

Pickup level:	0.000 to 3.000 pu in steps of 0.001
Polarizing:	Voltage, Current, Dual, Dual-1, Dual-V
Level accuracy:	±0.5% of reading from 10 to 208 V
Pickup delay:	0.00 to 600.00 s in steps of 0.01
Reset delay:	0.00 to 600.00 s in steps of 0.01
Timing accuracy:	±3% or ±20 ms (whichever is greater)
Operate time:	< 30 ms at 1.10 × Pickup at 60 Hz

PROTECTION

OPEN POLE DETECTOR

Detects an open pole condition, monitoring breaker auxiliary contacts, the current in each

phase and optional voltages on the line

Current pickup level:	0.000 to 30.000 pu in steps of 0.001
Line capacitive reactances (XC1, XC0):	300.0 to 9999.9 sec. W in steps of 0.1

Remote current pickup level:	0.000 to 30.000 pu in steps of 0.001
Current dropout level:	Pickup + 3%, not less than 0.05 pu

OVERFREQUENCY

Pickup level:	20.00 to 65.00 Hz in steps of 0.01
Dropout level:	Pickup - 0.03 Hz
Level accuracy:	±0.01 Hz
Time delay:	0 to 65.535 s in steps of 0.001
Timer accuracy:	±3% or 4 ms, whichever is greater

PHASE COMPARISON PROTECTION (87PC)

Signal Selection:	Mixed I ₂ - K × I ₁ (K=0.00 to 0.25 in steps of 0.01, or I ₀)
Angle Reference:	0 to 360° leading in steps of 1

Fault detector low:

Instantaneous Overcurrent:	0.02 to 15.00 pu in steps of 0.01
I ₂ × Z - V ₂ :	0.005 to 15.00 pu in steps of 0.01
d ₂ / d ₁ :	0.01 to 5.00 pu in steps of 0.01
d ₁ / d ₂ :	0.01 to 5.00 pu in steps of 0.01

Fault detector High:

Instantaneous Overcurrent:	0.10 to 15.00 pu in steps of 0.01
I ₂ × Z - V ₂ :	0.005 to 15.00 pu in steps of 0.01
d ₂ / d ₁ :	0.01 to 5.00 pu in steps of 0.01
d ₁ / d ₂ :	0.01 to 5.00 pu in steps of 0.01

Signal Symmetry

Adjustment:	-0.5 to 5.0 ms in steps of 0.1
Channel Delay Adjustment:	0.000 to 30.00 ms in steps of 0.001
Channel Adjustments:	channel delay and signal symmetry compensation
Operate Time (Typical):	3/4 cycle for single phase comparison
Trip Security:	First coincidence or enhanced
Second Coincidence Timer:	10 to 200 ms in steps of 1

Enhanced Stability

Angle:	40 to 180° in steps of 1
--------	--------------------------

PHASE DIRECTIONAL OVERCURRENT

Relay connection:	90° (quadrature)
Quadrature voltage:	
ABC phase seq.:	phase A (V _{AB}), phase B (V _{CA}), phase C (V _{BA})

ACB phase seq.:

Phase A (V _{CA}), phase B (V _{AB}), phase C (V _{BC})	
Polarizing voltage threshold:	0.000 to 3.000 pu in steps of 0.001
Current sensitivity threshold:	0.05 pu
Characteristic angle:	0 to 359° in steps of 1
Angle accuracy:	±2°
Operation time: (FlexLogic elements):	< 12 ms, typically
Tripping (reverse load, forward fault):	< 8 ms, typically
Blocking (forward load, reverse fault):	< 8 ms, typically

PHASE DISTANCE

Characteristic:	Mho (memory polarized or offset) or Quad (memory polarized or non-directional), selectable individually per zone
Number of zones:	Up to 5
Directionality:	Forward, Reverse, or Non-Directional per zone
Reach (secondary W):	0.02 to 250.00 in steps of 0.01
Reach accuracy:	±5% including the effect of CVT transients up to an SIR of 30

Distance:	
Characteristic angle:	30 to 90° in steps of 1
Comparator limit angle:	30 to 90° in steps of 1
Directional supervision:	
Characteristic angle:	30 to 90° in steps of 1
Limit angle:	30 to 90° in steps of 1
Right blinder (Quad only):	
Reach:	0.02 to 500 in steps of 0.01
Characteristic angle:	60 to 90° in steps of 1
Left Blinder (Quad only):	
Reach:	0.02 to 500 in steps of 0.01
Characteristic angle:	60 to 90° in steps of 1
Time delay:	0.000 to 65.535 s in steps of 0.001
Timing accuracy:	±3% or 4 ms, whichever is greater
Current supervision:	
Level:	line-to-line current
Pickup:	0.050 to 30.000 pu in steps of 0.001
Dropout:	97 to 98%

PROTECTION

Memory duration:	5 to 25 cycles in steps of 1
VT location:	all delta-wye and wye-delta transformers

CT location:	all delta-wye and wye-delta transformers
Voltage supervision pickup (series compensation applications):	0 to 5.000 pu in steps of 0.001

PHASE DISTANCE OPERATING TIME CURVES

The operating times are response times of a microprocessor part of the relay. See output contacts specifications for estimation of the total response time for a particular application. The operating times are average times including variables such as fault inception angle or type of a voltage source (magnetic VTs and CVTs).

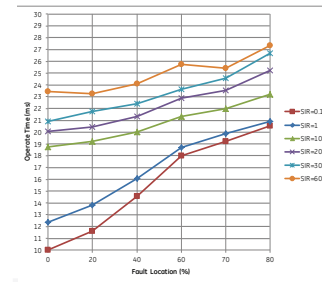

PHASE/NEUTRAL/GROUND TOC

Pickup level:	0.000 to 30.000 pu in steps of 0.001
Dropout level:	97 to 98% of pickup
Level accuracy:	±0.5% of reading or ±1% of rated (whichever is greater)
0.1 to 2.0 × CT rating:	±1.5% of reading
> 2.0 × CT rating:	< 2%
Overreach:	0.00 to 600.00 s in steps of 0.01
Pickup delay:	0.00 to 600.00 s in steps of 0.01
Reset delay:	< 16ms at 3 × pickup at 60Hz (Phase/Ground IOC) < 20ms at 3 × pickup at 60Hz (Neutral IOC)
Operate time:	Operate at 1.5 × Pickup ±3% or ± 4 ms (whichever is greater)

PHASE/NEUTRAL/GROUND TOC

Current:	Phasor or RMS
Pickup level:	0.000 to 30.000 pu in steps of 0.001
Dropout level:	97% to 98% of Pickup
Level accuracy:	for 0.1 to 2.0 × CT: ±0.5% of reading or ±1% of rated (whichever is greater) for > 2.0 × CT: ±1.5% of reading > 2.0 × CT rating

Curve shapes:	IEEE Moderately/Very/Extremely Inverse; IEC (and BS) A/B/C and Short Inverse; GE IAC Inverse, Short/Very/Extremely Inverse; I2t; FlexCurves, (programmable); Definite Time (0.01 s base curve)
Curve multiplier:	Time Dial = 0.00 to 600.00 in steps of 0.01
Reset type:	Instantaneous/Timed (per IEEE)
Timing accuracy:	Operate at > 1.03 × actual Pickup ±3.5% of operate time or ±½ cycle (whichever is greater)

PHASE OVERVOLTAGE

Voltage:	Phasor only
Pickup level:	0.000 to 3.000 pu in steps of 0.001
Dropout level:	97 to 98% of Pickup
Level accuracy:	±0.5% of reading from 10 to 208V
Pickup delay:	0.00 to 600.00 in steps of 0.01 s
Operate time:	< 30 ms at 1.10 × Pickup at 60 Hz
Timing accuracy:	±3% or ±4 ms (whichever is greater)

PHASE UNDERVOLTAGE

Voltage:	Phasor only
Pickup level:	0.000 to 3.000 pu in steps of 0.001
Dropout level:	102 to 103% of Pickup
Level accuracy:	±0.5% of reading from 10 to 208V
Curve shapes:	GE IAV Inverse; Definite Time (0.1s base curve)
Curve multiplier:	Time Dial = 0.00 to 600.00 in steps of 0.01
Timing accuracy:	Operate at < 0.90 × Pickup ±3.5% of operate time or ±4 ms (whichever is greater)

PILOT-AIDED SCHEMES

Direct Underreaching Transfer Trip (DUTT)	
Permissive Underreaching Transfer Trip (PUTT)	
Permissive Overreaching Transfer Trip (POTT)	
Hybrid POTT Scheme	
Directional Comparison Blocking Scheme	
Customizable version of the POTT and DCB schemes (POTT and DCB)	

UR Technical Specifications

PROTECTION

POWER SWING DETECT

Functions: Power swing block, Out-of-step trip
 Characteristic: Mho or Quad
 Measured impedance: Positive-sequence
 Blocking / tripping: 2-step or 3-step zones:
 Tripping mode: Early or Delayed
 Current supervision:
 Pickup level: 0.050 to 30.000 pu in steps of 0.001
 Dropout level: 97 to 98% of Pickup
 Fwd / reverse reach (sec. W): 0.10 to 500.00W in steps of 0.01
 Left and right blinders (sec. W): 0.10 to 500.00W in steps of 0.01
 Impedance accuracy: ±5%
 Fwd / reverse angle impedances: 40 to 90° in steps of 1
 Angle accuracy: ±2°
 Characteristic limit angles: 40 to 140° in steps of 1
 Timers: 0.000 to 65.535 s in steps of 0.001
 Timing accuracy: ±3% or 4 ms, whichever is greater

RATE OF CHANGE OF FREQUENCY

d/dt trend: increasing, decreasing, bi-directional
 d/dt pickup level: 0.10 to 15.00 Hz/s in steps of 0.01
 d/dt dropout level: 96% of pickup
 d/dt level accuracy: 80 mHz/s or 3.5%, whichever is greater
 Overvoltage supv.: 0.100 to 3.000 pu in steps of 0.001
 Overcurrent supv.: 0.000 to 30.000 pu in steps of 0.001
 Pickup delay: 0 to 65.535 s in steps of 0.001
 Reset delay: 0 to 65.535 s in steps of 0.001
 Time accuracy: ±3% or ±4 ms, whichever is greater
 95% settling time for d/dt:
 Operate time:
 at 2 x pickup: 12 cycles
 at 3 x pickup: 8 cycles
 at 5 x pickup: 6 cycles

RESTRICTED GROUND FAULT

Pickup: 0.000 to 30.000 pu in steps of 0.001
 Dropout: 97 to 98% of Pickup
 Slope: 0 to 100% in steps of 1%
 Pickup delay: 0 to 600.00 s in steps of 0.001
 Dropout delay: 0 to 600.00 s in steps of 0.01
 Operate time: < 1 power system cycle
SENSITIVE DIRECTIONAL POWER
 Measured power: 3-phase, true RMS
 Number of stages: 2
 Characteristic angle: 0 to 359° in steps of 1
 Calibration angle: 0.00 to 0.95° in steps of 0.05
 Minimum power: -1.200 to 1.200 pu in steps of 0.001
 Pickup level accuracy: ±1% or ±0.001 pu, whichever is greater
 Hysteresis: 2% or 0.001 pu, whichever is greater
 Pickup delay: 0 to 600.00 s in steps of 0.01
 Time accuracy: ±3% or ±4 ms, whichever is greater
 Operate time: 50 ms

SPLIT PHASE PROTECTION

Operating quantity: split phase CT current biased by generator load current
 Pickup level: 0.000 to 1.500 pu in steps of 0.001
 Dropout level: 97 to 98% of pickup
 Level accuracy: ±0.5% of reading or ±1% of rated
 Pickup delay: 0.000 to 65.535 s in steps of 0.001
 Time accuracy: ±3% of ± cycles, whichever is greater
 Operate time: < 5 cycles at 1.10 x pickup at 60Hz

STATOR DIFFERENTIAL

Pickup: 0.050 to 1.00 pu in steps of 0.01
 Slope 1/2: 1 to 100% in steps of 1
 Break 1: 1.00 to 1.50 pu in steps of 0.01
 Break 2: 1.50 to 30.00 pu in steps of 0.01
 Level accuracy: ±2%

SYNCHROCHECK

Max voltage difference: 0 to 400000 V in steps of 1
 Max angle difference: 0 to 100° in steps of 1
 Max freq. difference: 0.00 to 2.00 Hz in steps of 0.01
 Hysteresis for max. freq. diff.: 0.00 to 0.10 Hz in steps of 0.01

Dead source function: None, LV1 & DV2, DV1 & LV2, DV1 or DV2, DV1 xor DV2, DV1 & DV2 (L = Live, D = Dead)

PROTECTION

THERMAL MODEL

Thermal overload curves: Standard curve, FlexCurve, voltage dependent curve
 Standard Curve Time Multiplier: 0.00 to 600.00 in steps of 0.01
 Thermal Overload Pickup: pu = overload factor x FLA
 Overload (OF): 1.00 to 1.50 in steps of 0.001
 Standard Overload Curve: TD x 2.2116623

$$0.02530337 \times \left(\frac{I_{motor}}{OF \times FLA} \right)^2 + 0.05054758 \times \frac{I_{motor}}{OF \times FLA}$$

Motor Rated Voltage: 1 to 50000 V in steps of 1
 Thermal Motor Biasing: Current unbalance, RTDs
 Thermal Model Update Rate: 1 power cycle
 Stopped/Running Time Cool Constants: 1 to 65000 min. in steps of 1
 Stopped/Running Time Cool Constants: Exponential
 Decay: Hot/Cold Safe Stall Ratio: 0.01 to 1.00 in steps of 0.01
 Current Accuracy: Per phase current inputs
 Current Source: True RMS
 Timing Accuracy: ± 100 ms or ± 2% whichever is greater
 Timing Accuracy for Voltage Dependent Overload: ± 100 ms or ± 4%, whichever is greater

THIRD HARMONIC NEUTRAL UNDERVOLTAGE

Operating quantity: 3rd harmonic of auxiliary undervoltage
 Undervoltage: Pickup level: 0.000 to 3.000 pu in steps of 0.001
 Dropout level: 102 to 103% of pickup
 Accuracy: ±2% of reading from 1 to 120V
 Power: Pickup level: 0.000 to 1.200 pu in steps of 0.001
 Dropout level: 97 to 98% of pickup
 Accuracy: ±5% or ±0.01 pu, whichever is greater
 Undervoltage Inhibit Level: 0.000 to 3.000 pu in steps of 0.001 pu
 Accuracy: ±0.5% of reading from 10 to 208V
 Pickup delay: 0 to 600.00 s in steps of 0.01
 Time accuracy: ±3% or ±20 ms, whichever is greater
 Operate time: < 30 ms at 1.10 x pickup at 60 Hz

TRANSFORMER AGING FACTOR

Operating quantity: computed aging acceleration factor (pu)
 Pickup level: 1 to 10 pu in steps of 0.1
 Pickup delay: 0 to 30000 min. in steps of 1

TRANSFORMER INSTANTANEOUS DIFFERENTIAL

Pickup level: 2.00 to 30.00 pu in steps of 0.01
 Dropout level: 97 to 98% of pickup
 Level accuracy: ±0.5% of reading or ±1% of rated (whichever is greater)
 Operate time: < 20 ms at 3 x pickup at 60 Hz

TRANSFORMER HOTTEST-SPOT TEMPERATURE

Operating quantity: computed temperature in °C
 Pickup level: 50 to 300°C in steps of 1
 Dropout level: 1°C below pickup
 Pickup delay: 0 to 30000 min. in steps of 1

TRANSFORMER LOSS OF LIFE

Operating quantity: computed accumulated transformer loss of life, in hours
 Pickup level: 0 to 500000 hours in steps of 1

TRANSFORMER PERCENT DIFFERENTIAL

Characteristic: Differential Restraint pre-set
 Number of zones: 2
 Minimum pickup: 0.05 to 1.00 pu in steps of 0.001
 Slope 1 range: 15 to 100% in steps of 1%
 Slope 2 range: 50 to 100% in steps of 1%
 Kneepoint 1: 1.0 to 2.0 pu in steps of 0.0001
 Kneepoint 2: 2.0 to 30.0 pu in steps of 0.0001
 2nd harmonic inhibit level: 1.0 to 40.0% in steps of 0.1

2nd harmonic inhibit function: Adaptive, Traditional, Disabled
 2nd harmonic inhibit mode: Per-phase, 2-out-of-3, Average

5th harmonic inhibit range: 1.0 to 40.0% in steps of 0.1

Operate times: Harmonic inhibits selected: 20 to 30 ms

No harmonic inhibits selected: 5 to 20 ms

Dropout level: 97 to 98% of pickup
 Level accuracy: ±0.5% of reading or ±1% of rated (whichever is greater)

PROTECTION

TRIP OUTPUT

Collects trip and reclose input requests and issues outputs to control tripping and reclosing.
 Communications timer delay: 0 to 65535 s in steps of 0.001
 Evolving fault timer: 0.000 to 65.535 s in steps of 0.001
 Timing accuracy: ±3% or 4 ms, whichever is greater

UNDERFREQUENCY

Minimum signal: 0.10 to 1.25 pu in steps of 0.01
 Pickup level: 20.00 to 65.00 Hz in steps of 0.01
 Dropout level: Pickup + 0.03 Hz
 Level accuracy: ±0.01 Hz
 Time delay: 0 to 65.535 s in steps of 0.001
 Timer accuracy: ±3% or 4 ms, whichever is greater

VOLTS PER HERTZ

Voltage: Phasor only
 Pickup level: 0.80 to 4.00 in steps of 0.01 pu V/Hz
 Dropout level: 97 to 98% of Pickup
 Level accuracy: ±0.02 pu
 Timing curves: Definite Time; Inverse A, B, and C, FlexCurves A, B, C, and D

TD Multiplier: 0.05 to 600.00 s in steps of 0.01
 Reset delay: 0.0 to 1000.0 s in steps of 0.1
 Timing accuracy: ±3% or ± 4 ms (whichever is greater)

VT FUSE FAIL

Monitored parameters: V, 2, V, 1, I, 1
WATTMETRIC ZERO-SEQUENCE DIRECTIONAL
 Measured Power: Zero-Sequence
 Number of Elements: 2
 Characteristic Angle: 0 to 360° in steps of 1
 Minimum Power: 0.001 to 1.20pu in steps of 0.001
 Pickup Level Accuracy: ±1% or ± 0.0025 pu, whichever is greater

Pickup Delay: Definite time (0 to 600.00 s in steps of 0.01), inverse time, or FlexCurve
 Inverse Time Multiplier: 0.01 to 2.00 s in steps of 0.01
 Time Accuracy: ±3% or ±8 ms, whichever is greater
 Operate Time: <30 ms at 60 Hz

MONITORING

DATA LOGGER

Number of channels: 1 to 16
 Parameters: Any available analog actual value
 Sampling rate: 15 to 3600000 ms in steps of 1
 Trigger: Any FlexLogic operand
 Mode: Continuous or Triggered (NN is dependent on memory)
 Storage capacity: 01 channel for NN days
 1-second rate: 16 channels for NN days
 60-minute rate: 01 channel for NN days
 16 channels for NN days

EVENT RECORDER

Capacity: 1024 events
 Time-tag: to 1 microsecond
 Triggers: Any element pickup, dropout or operate
 Digital input change of state
 Digital output change of state
 Self-test events
 Data storage: In non-volatile memory

FAULT LOCATOR

Method: Single-ended
 Maximum accuracy if: Fault resistance is zero or fault currents from all line terminals are in phase
 Relay accuracy: ±1.5% (V > 10 V, I > 0.1 pu)
 Worst-case accuracy: VT%error + (user data)
 CT%error + (user data)
 ZLine%error + (user data)
 METHOD%error + (Chapter 6)
 RELAY ACCURACY%error + (1.5%)

HIGH-IMPEDANCE FAULT DETECTION (HIZ)

Detections: Arc Suspected, Arc Detected, Downed Conductor, Phase Identification

OSCILLOGRAPHY

Maximum records: 64
 Sampling rate: 64 samples per power cycle
 Triggers: Any element pickup, dropout or operate
 Digital input change of state
 Digital output change of state
 Any FlexLogic Operand
 FlexLogic Equation
 AC input channels
 Element state
 Digital input state
 Digital output state

Data: In non-volatile memory

USER-PROGRAMMABLE FAULT REPORT

Number of elements: 2
 Pre-fault trigger: any FlexLogic operand
 Fault trigger: any FlexLogic operand
 Recorder quantities: 32 (any FlexAnalog value)

UR Technical Specifications

MONITORING

PHASOR MEASUREMENT UNIT

Output format: per IEEE C37.118 standard
Number of channels: 14 synchrophasors, 16 analogs, 16 digitals

TVE (total vector error): <1%
Triggering: frequency, voltage, current, power, rate of change of frequency, user-defined

Reporting rate: 1, 2, 5, 10, 12, 15, 20, 25, 30, 50, 60 or 120 times per second
Number of clients: One over TCP/IP port, two over UDP/IP ports

TAC ranges: As indicated in appropriate specifications sections

Network reporting format: 16-bit integer or 32-bit IEEE floating point numbers
Network reporting style: Rectangular (real and imaginary) or polar (magnitude and angle) coordinates

Filtering: P and M class
Calibration: Angle $\pm 5^\circ$, magnitude $\pm 5\%$ per phase

Compensation: -180 to 180° in steps of 30° (current and voltage components)

Mode of operation: Normal and test
PMU Recording: 46 configurable channels (14 synchrophasor, 16 digital, 16 analogs)

METERING

RMS CURRENT: PHASE, NEUTRAL, AND GROUND

Accuracy at:
0.1 to 2.0 x CT rating: $\pm 0.25\%$ of reading or $\pm 0.1\%$ of rated (whichever is greater)
> 2.0 x CT rating: $\pm 1.0\%$ of reading

RMS VOLTAGE
Accuracy: $\pm 0.5\%$ of reading from 10 to 208 V

REAL POWER (WATTS)
Accuracy: $\pm 1.0\%$ of reading at $-0.8 < PF < -1.0$ and $0.8 < PF < 1.0$

REACTIVE POWER (VARS)
Accuracy: $\pm 1.0\%$ of reading at $-0.2 < PF < 0.2$

APPARENT POWER (VA)
Accuracy: $\pm 1.0\%$ of reading

WATT-HOURS (POSITIVE AND NEGATIVE)
Accuracy: $\pm 2.0\%$ of reading

Range: ± 0 to 2×10^9 MWh
Parameters: 3-phase only
Update rate: 50 ms

VAR-HOURS (POSITIVE AND NEGATIVE)
Accuracy: $\pm 2.0\%$ of reading

Range: ± 0 to 2×10^9 Mvarh
Parameters: 3-phase only
Update rate: 50 ms

CURRENT HARMONICS
Harmonics: 2nd to 25th harmonic; per phase, displayed as a % of f1 (fundamental frequency phasor) THD: per phase, displayed as a % of f1

Accuracy:
Harmonics: 1. $f_1 > 0.4pu$: (0.20% + 0.035% / harmonic) of reading or 0.15% of 100%, whichever is greater
2. $f_1 < 0.4pu$: as above plus %error of f1

THD: 1. $f_1 > 0.4pu$: (0.25% + 0.035% / harmonic) of reading or 0.20% of 100%, whichever is greater
2. $f_1 < 0.4pu$: as above plus %error of f1

DEMAND
Measurements: Phases A, B, and C present and maximum measured currents
3-Phase Power (P, Q, and S) present and maximum measured currents
Accuracy: $\pm 2.0\%$

FREQUENCY
Accuracy at
V = 0.8 to 1.2 pu: ± 0.01 Hz (when voltage signal is used for frequency measurement)
I = 0.1 to 0.25 pu: ± 0.05 Hz
I > 0.25 pu: ± 0.02 Hz (when current signal is used for frequency measurement)

VOLTAGE HARMONICS
Harmonics: 2nd to 25th harmonic; per phase, displayed as a % of f1 (fundamental frequency phasor) THD: per phase, displayed as a % of f1

Accuracy:
Harmonics: 1. $f_1 > 0.4pu$: (0.20% + 0.035% / harmonic) of reading or 0.15% of 100%, whichever is greater
2. $f_1 < 0.4pu$: as above plus %error of f1

THD: 1. $f_1 > 0.4pu$: (0.25% + 0.035% / harmonic) of reading or 0.20% of 100%, whichever is greater
2. $f_1 < 0.4pu$: as above plus %error of f1

USER-PROGRAMMABLE ELEMENTS

CONTROL PUSHBUTTONS

Number of pushbuttons: 3 (standard) or 16 (optional)
Operation: drive FlexLogic operands

FLEXCURVES

Number: 4 (A through D)
Reset points: 40 (0 through 1 of pickup)
Operate points: 80 (1 through 20 of pickup)
Time delay: 0 to 65535 ms in steps of 1

FLEXLOGIC

Programming language: Reverse Polish Notation with graphical visualization (keypad programmable)

Lines of code: 512
Internal variables: 64
Supported operations: NOT, XOR, OR (2 to 16 inputs), AND (2

to 16 inputs), NOR (2 to 16 inputs), NAND (2 to 16 inputs), Latch (Reset Dominant), Edge Detectors, Timers
Inputs: any logical variable, contact, or virtual input

Number of timers: 32
Pickup delay: 0 to 60000 (ms, sec., min.) in steps of 1

Dropout delay: 0 to 60000 (ms, sec., min.) in steps of 1

FLELEMENTS

Number of elements: 8 or 16
Operating signal: any analog actual value, or two values in Differential mode

Operating signal mode: Signed or Absolute Value
Operating mode: Level, Delta

Comparator direction: Over, Under
Pickup Level: -30,000 to 30,000 pu in steps of 0.001

Hysteresis: 0.1 to 50.0% in steps of 0.1

Delta dt: 20 ms to 60 days
Pickup & dropout delay: 0.000 to 65.535 s in steps of 0.001

FLEXSTATES

Number: up to 256 logical variables grouped under 16 Modbus addresses
Programmability: any logical variable, contact, or virtual input

LED TEST

Initiation: from any digital input or user-programmable condition

Number of tests: 3, interruptible at any time
Duration of full test: approximately 3 minutes

Test sequence 1: all LEDs on
Test sequence 2: all LEDs off, one LED at a time on for 1 s

Test sequence 3: all LEDs on, one LED at a time off for 1 s

NON-VOLATILE LATCHES

Type: Set-dominant or Reset-dominant

Number: 16 (individually programmed)
Output: Stored in non-volatile memory

Execution sequence: As input prior to protection, control, and FlexLogic.

SELECTOR SWITCH

Number of elements: 2
Upper position limit: 1 to 7 in steps of 1

Selecting mode: Time-out or Acknowledge

Time-out timer: 3.0 to 60.0 s in steps of 0.1
Control inputs: step-up and 3-bit restore from non-volatile memory or synchronize to a 3-bit control input

Power-up mode: memory or synchronize to a 3-bit control input

USER-DEFINABLE DISPLAYS

Number of displays: 16
Lines of display: 2×20 alphanumeric characters up to 5, any Modbus register addresses

Parameters: keypad, or any user-programmable condition, including pushbuttons

USER-PROGRAMMABLE LEDS

Number: 48 plus Trip and Alarm
Programmability: from any logical variable, contact, or virtual input

Reset mode: Self-reset or Latched

USER-PROGRAMMABLE PUSHBUTTONS (OPTIONAL)
Number of pushbuttons: 12
Mode: Self-Reset, Latched

Display message: 2 lines of 20 characters each

8-BIT SWITCH

Number of elements: 6

Input signals: two 8-bit integers via FlexLogic operands

Control: any FlexLogic operand

Response time: < 8 ms at 60 Hz, < 10 ms at 50 Hz

INPUTS

AC CURRENT

CT rated primary: 1 to 50000 A
CT rated secondary: 1 A or 5 A by connection
Nominal frequency: 20 to 65 Hz
Relay burden: < 0.2 VA at rated secondary

Conversion range: 0.02 to 46 x CT rating RMS symmetrical

Standard CT: 0.02 to 46 x CT rating RMS symmetrical
Sensitive Ground/Hi-Z CT module: 0.002 to 4.6 x CT rating RMS symmetrical
Current withstand: 20 ms at 250 times rated
1 sec. at 100 times rated
continuous at 3 times rated
continuous 4xInom; URs equipped with 24 CT inputs have a maximum operating temp. of 50°C

AC VOLTAGE

VT rated secondary: 50.0 to 240.0 V
VT ratio: 1.00 to 24000.00
Nominal frequency: 20 to 65 Hz For the L90, the nominal system frequency should be chosen as

50 Hz or 60 Hz only.
Relay burden: < 0.25 VA at 120 V
Conversion range: 1 to 275 V
Voltage withstand: continuous at 260 V to neutral
1 min./hr at 420 V to neutral

CONTACT INPUTS
Dry contacts: 1000 Ω maximum
Wet contacts: 300 V DC maximum

Selectable thresholds: 17 V, 33 V, 84 V, 166 V
Tolerance: $\pm 10\%$
Contacts Per Common Return: 4

Recognition time: < 1 ms
Debounce timer: 0.0 to 16.0 ms in steps of 0.5
Continuous Current: 3mA (when energized)
Draw: 50 to 70 mA

CONTACT INPUTS WITH AUTO-BURNISHING
Dry contacts: 1000 Ω maximum
Wet contacts: 300 V DC maximum

Selectable thresholds: 17 V, 33 V, 84 V, 166 V
Tolerance: $\pm 10\%$
Contacts Per Common Return: 2

Recognition time: < 1 ms
Debounce timer: 0.0 to 16.0 ms in steps of 0.5
Continuous Current: 3mA (when energized)
Draw: 25 to 50 ms

Auto-Burnish Impulse Current: 50 to 70 mA
Duration of Auto-Burnish Impulse: 25 to 50 ms

DCMA INPUTS
Current input (mA DC): 0 to -1, 0 to +1, -1 to +1, 0 to 5, 0 to 10, 0 to 20, 4 to 20 (programmable)
Input impedance: $379 \pm 10\%$
Conversion range: -1 to +20 mA DC

Accuracy: $\pm 0.2\%$ of full scale
Type: Passive

DIRECT INPUTS
Number of input points: 32
No. of remote devices: 16

Default states on loss of comms.: On, Off, Latest/Off, Latest/On
Ring configuration: Yes, No
Data rate: 64 or 128 kbps
CRC: 32-bit

CRC alarm: Rate of messages failing the CRC
Responding to Monitoring message count: 10 to 10000 in steps of 1

Alarm threshold: 1 to 1000 in steps of 1
Unreturned message alarm: Rate of unreturned messages in the ring configuration
Responding to Monitoring message count: 10 to 10000 in steps of 1

Alarm threshold: 1 to 1000 in steps of 1

IRIG-B INPUT
Amplitude modulation: 1 to 10 V pk-pk
DC shift: TTL
Input impedance: 22 kW
Isolation: 2 kV

REMOTE INPUTS (IEC 61850 GSSE)
Number of input points: 32, configured from 64 incoming bit pairs
Number of remote devices: 16

Default states on loss of comms.: On, Off, Latest/Off, Latest/On

RTD INPUTS
Types (3-wire): 100 Ω Platinum, 100 Ω & 120 Ω Nickel, 10 Ω Copper

Sensing current: 5 mA
Range: -50 to +250°C
Accuracy: $\pm 2^\circ\text{C}$
Isolation: 36 V pk-pk

UR Technical Specifications

OUTPUTS
CONTROL POWER EXTERNAL OUTPUT (FOR DRY CONTACT INPUT)
Capacity: 100 mA DC at 48 V DC
Isolation: ±300 Vpk
DCMA OUTPUTS
Range: -1 to 1 mA, 0 to 1 mA, 4 to 20 mA
Max. load resistance: 12 k for -1 to 1 mA range
 12 k for 0 to 1 mA range
 600 for 4 to 20 mA range
Accuracy:
 ±0.75% of full-scale for 0 to 1 mA range
 ±0.5% of full-scale for -1 to 1 mA range
 ±0.75% of full-scale for 0 to 20 mA range
 100 ms
99% Settling time to a step change:
Isolation: 1.5 kV
Driving signal: any FlexAnalog quantity
Upper & lower limit for the driving signal: -90 to 90 pu in steps of 0.001
DIRECT OUTPUTS
Output points: 32
FORM-A CURRENT MONITOR
Threshold current: approx. 80 to 100 mA
FORM-A RELAY
Make & carry for 0.2s: 30 A as per ANSI C37.90
Carry continuous: 6 A
Break at L/R of 40 ms: 1 A DC max. at 24 V
 0.5 A DC max. at 48 V
 0.3 A DC max. at 125 V
 0.2 A DC max. at 250 V
Operate time: < 4 ms
Contact material: Silver alloy
FORM-A VOLTAGE MONITOR
Applicable voltage: approx. 15 to 250 V DC
Trickle current: approx. 1 to 2.5 mA

INPUT VOLTAGE	IMPEDANCE	
	2W RESISTOR	1W RESISTOR
250 V DC	20 K	50K
120 V DC	5 K	2 K
48 V DC	2 K	2 K
24 V DC	2 K	2 K

FORM-C AND CRITICAL FAILURE RELAY
Make & carry for 0.2 s: 30 A
Carry continuous: 8 A
Break at L/R of 40 ms: 0.25 A DC max. at 48 V
 0.10 A DC max. at 125 V
 < 8 ms
Operate time: < 4 ms
Contact material: Silver alloy
FAST FORM-C RELAY
Make & carry: 0.1 A max. (resistive load)
Minimum load impedance: < 0.6 ms
Operate time: 100, 2
Resistor:
IRIG-B OUTPUT
Amplitude: 10 V peak-peak RS485 level
Maximum load: 100 ohms
Time delay: 1 ms for AM input
 40 µs for DC-shift input
 2 kV
Isolation:
LATCHING RELAY
Make & carry for 0.2 s: 30 A as per ANSI C37.90
Carry continuous: 6 A
Break at L/R of 40 ms: 0.25 A DC max.
Operate time: < 4 ms
Contact material: Silver alloy
Control: separate operate and reset inputs
Control mode: operate-dominant or reset-dominant

REMOTE OUTPUTS (IEC 61850 GSSE)
Standard output points: 32
User output points: 32
SOLID-STATE OUTPUT RELAY
Operate & release time: <100 µs
Maximum voltage: 265 V DC
Maximum continuous current: 5 A at 45°C; 4 A at 65°C
Make & carry for 0.2 s: as per ANSI C37.90
For 0.3s: 300 A
Breaking capacity:

COMMUNICATIONS
RS232
Front port: 19.2 kbps, Modbus® RTU, DNP 3.0
RS485
1 or 2 rear ports: Up to 115 kbps, Modbus® RTU, DNP 3.0 isolated together at 36 Vpk
Typical distance: 1200 m
Isolation: 2 kV
ETHERNET PORT
10Base-F: 820 nm, multi-mode, supports half-duplex/full-duplex fiber optic with ST connector
Redundant 10Base-F: 820 nm, multi-mode, half-duplex/full-duplex fiber optic with ST connector
10Base-T: RJ45 connector
Power budget: 10 dB
Max optical input power: -7.6 dBm
Max optical output power: -20 dBm
Receiver sensitivity: -30 dBm
Typical distance: 1.65 km
SNTP clock synchronization error: <10 ms (typical)

PROTOCOLS

	RS232	RS485	10BaseF	10BaseT	100BaseT
IEC 61850	*	*	*	*	*
DNP 3.0	*	*	*	*	*
Modbus	*	*	*	*	*
IEC104	*	*	*	*	*
EGD			*	*	*

INTER-RELAY COMMUNICATIONS SHIELDED TWISTED-PAIR INTERFACE OPTIONS

INTERFACE TYPE	TYPICAL DISTANCE
RS422	1200m
G.703	100m

* NOTE: RS422 distance is based on transmitter power and does not take into consideration the clock source provided by the user.

LINK POWER BUDGET

EMITTER, FIBER TYPE	TRANSMIT POWER	RECEIVED SENSITIVITY	POWER BUDGET
820nm LED Multimode	-20dBm	-30dBm	10dB
1300 nm LED Multimode	-21dBm	-30dBm	9dB
1300 nm ELED Multimode	-21dBm	-30dBm	9dB
1300 nm Laser Singlemode	-1dBm	-30dBm	29dB
1550 nm Laser Singlemode	+5dBm	-30dBm	35dB

* NOTE: These power budgets are calculated from the manufacturers' worst-case transmitter power and worst-case receiver sensitivity.

MAXIMUM OPTICAL INPUT POWER

EMITTED, FIBER TYPE	MAX. OPTICAL INPUT POWER
820 nm LED, Multimode	-7.6 dBm
1300 nm LED, Multimode	-11 dBm
1300 nm ELED, Singlemode	-14 dBm
1300 nm Laser, Singlemode	-14 dBm
1500 nm Laser, Singlemode	-14 dBm

TYPICAL LINK DISTANCE

EMITTED TYPE	FIBER TYPE	CONNECTOR TYPE	TYPICAL DISTANCE
820 nm LED	Multimode	-7.6 dBm	1.65 km
1300 nm LED	Multimode	-11 dBm	3.8 km
1300 nm ELED	Singlemode	-14 dBm	11.4 km
1300 nm Laser	Singlemode	-14 dBm	64 km
1500 nm Laser	Singlemode	-14 dBm	105 km

	IEC 647-5/UL508	UTILITY APPLICATION (AUTO-CLOSE SCHEME)	INDUSTRIAL APPLICATION
Operations/interval	5000 ops 1 s-On, 9 s-Off 1000 ops 0.5 s-On, 0.5 s-Off	5 ops/ 2 s-On, 0.2 s-Off within 1 minute	10000 ops/ 0.2 s-On, 30 s-Off
Break capability (0 to 250 VDC)	3.2 A L/R = 10 ms 1.6 A L/R = 20 ms 0.8 A L/R = 40 ms	10 A L/R = 40 ms	10 A L/R = 40 ms

INTER-RELAY COMMUNICATIONS
 * Note: Typical distances listed are based on the following assumptions for system loss. Actual losses will vary from one installation to another, the distance covered by your system may vary.
CONNECTOR LOSSES (TOTAL OF BOTH ENDS)
ST connector 2dB
FIBER LOSSES
 820 nm multimode 3 dB/km
 1300 nm multimode 1 dB/km
 1300 nm singlemode 0.35 dB/km
 1550 nm singlemode 0.25 dB/km
 Splice losses: One splice every 2 km, at 0.05 dB loss per splice

SYSTEM MARGIN
 3 dB additional loss added to calculations to compensate for all other losses.
 Compensate difference in transmitting and receiving (channel asymmetry) channel delays using GPS satellite clock: 10 ms

POWER SUPPLY
LOW RANGE
Nominal DC voltage: 24 to 48 V at 3 A
Min/max AC voltage: 20 / 60 V
 * NOTE: Low range is DC only.
HIGH RANGE
Nominal DC voltage: 125 to 250 V at 0.7 A
Min/max DC voltage: 88 / 300 V
Nominal AC voltage: 100 to 240 V at 50/60 Hz, 0.7 A
Min/max AC voltage: 88 / 265 V at 25 to 100 Hz

ALL RANGES
Volt withstand: 2 x Highest Nominal Voltage for 10 ms
Voltage loss hold-up: 50 ms duration at nominal
Power consumption: Typical = 15 VA; Max. = 30 VA

INTERNAL FUSE RATINGS
Low range power supply: 8 A / 250 V
High range power supply: 4 A / 250 V
INTERRUPTING CAPACITY
AC: 100 000 A RMS symmetrical
DC: 10 000 A
Hold up time: 200 ms

TYPE TESTS
Electrical fast transient: ANSI/IEEE C37.90.1
 IEC 61000-4-4
 IEC 60255-22-4
Oscillatory transient: ANSI/IEEE C37.90.1
 IEC 61000-4-12
Insulation resistance: IEC 60255-5
Dielectric strength: IEC 60255-6
Electrostatic discharge: EN 61000-4-2
Surge immunity: EN 61000-4-5
RFI susceptibility: ANSI/IEEE C37.90.2
 IEC 61000-4-3
 IEC 60255-22-3
 Ontario Hydro C-5047-77
 IEC 61000-4-6
Conducted RFI: IEC 61000-4-6
Voltage dips/interruptions/variations: IEC 61000-4-11
 IEC 60255-11
Power frequency magnetic field immunity: IEC 61000-4-8
 IEC 60255-21-1
Vibration test (sinusoidal): IEC 61000-4-8
Shock and bump: IEC 60255-21-2
 * NOTE: Type test report available upon request.

PRODUCTION TESTS
THERMAL
 Products go through an environmental test based upon an accepted quality level (AQL) sampling process

ENVIRONMENTAL OPERATING TEMPERATURES
Cold: IEC 60028-2-1, 16 h at -40°C
Dry Heat: IEC 60028-2-2, 16 h at +85°C

OTHER
Humidity/noncondensing: IEC 60068-2-30, 95%, Variant 1, 6 days
 Up to 2000 m

Altitude: Up to 2000 m
Installation Category: II

APPROVALS
 UL Listed for the USA and Canada
 Manufactured under an ISO9000 registered system.
CE LVD 73/23/EEC: IEC 1010-1
 EMC 81/336/EEC: EN 50081-2, EN 50082-2

