

## CompactLogix System

Catalog Numbers 1769-L16ER-BB1B, 1769-L18ER-BB1B, 1769-L18ERM-BB1B, 1769-L24ER-QB1B, 1769-L24ER-QBFC1B, 1769-L27ERM-QBFC1B, 1769-L30ER, 1769-L30ER-NSE, 1769-L30ERM, 1769-L33ER, 1769-L33ERM, 1769-L36ERM, 1769-AENTR, 1768-L43, 1768-L43S, 1768-L45, 1768-L45S

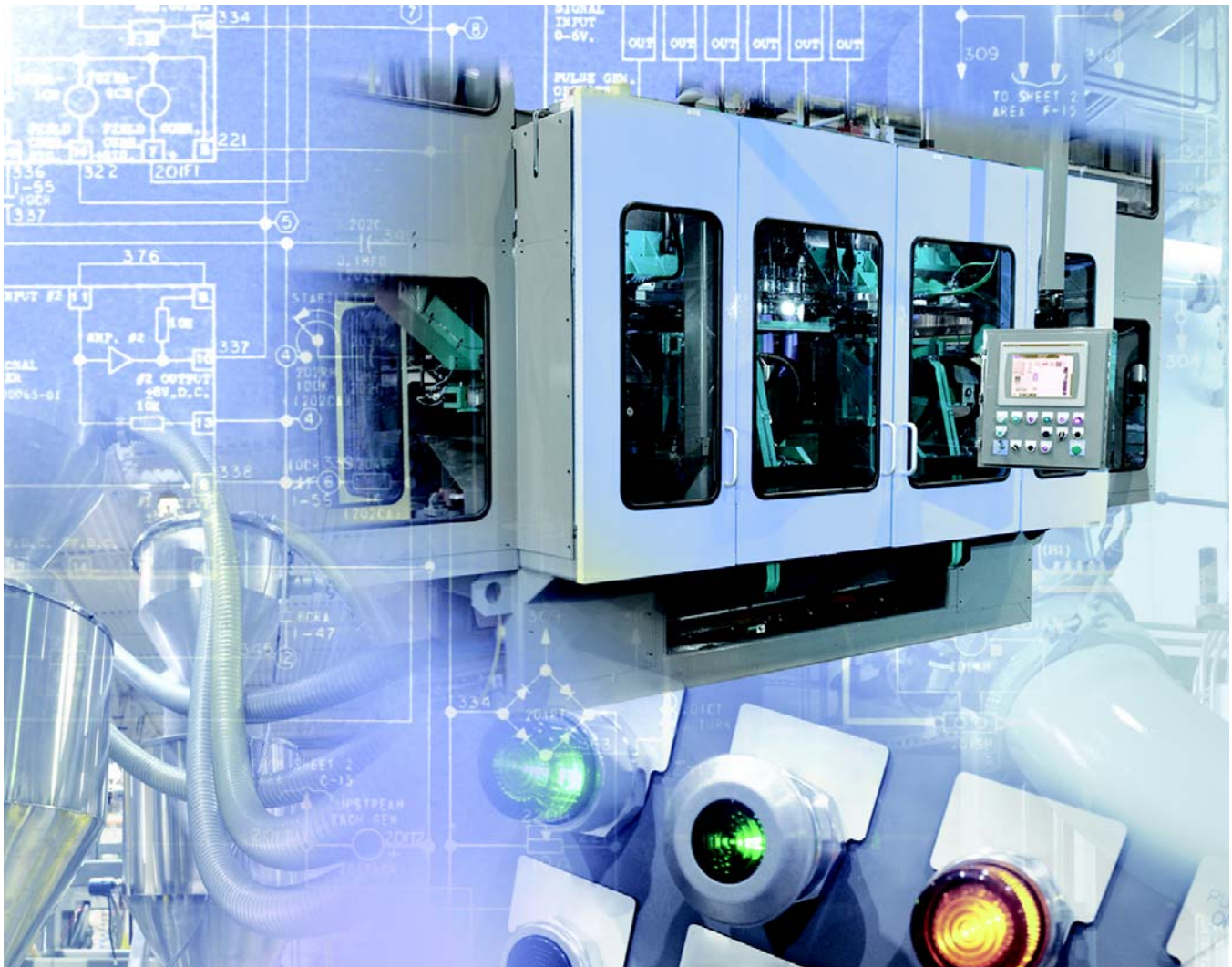

LISTEN.  
THINK.  
SOLVE.®

# Logix Controllers Comparison

Characteristic	ControlLogix 1756-71, 1756-L72, 1756-L73, 1756-L73XT, 1756-L74, 1756-L75 GuardLogix 1756-L72S, 1756-L73S, 1756-L73SXT	CompactLogix 1769-L30ER, 1769-L30ER-NSE, 1769-L30ERM, 1769-L33ER, 1769-L33ERM, 1769-L36ERM	CompactLogix 1769-L24ER-BB1B, 1769-L24ER-QBFC1B, 1769-L27ERM-QBFC1B	CompactLogix 1769-L16ER-BB1B, 1769-L18ER-BB1B, 1769-L18ERM-BB1B	CompactLogix 1768-L43, 1768-L45 Compact GuardLogix 1768-L43S, 1768-L45S
Controller tasks: • Continuous • Periodic • Event	32; 100 programs/task	32; 100 programs/task	32; 100 programs/task	32; 100 programs/task	• 1768-L43: 16; 32 programs/task • 1768-L45: 30; 32 programs/task
Event tasks	All event triggers	All event triggers	All event triggers	All event triggers, plus embedded inputs	All event triggers
User memory	<ul style="list-style-type: none"> <li>1756-L71: 2 MB</li> <li>1756-L72: 4 MB</li> <li>1756-L72S: 4 MB + 2 MB safety</li> <li>1756-L73, 1756-L73SXT, 1756-L73XT: 8 MB</li> <li>1756-L73S: 8 MB + 4 MB safety</li> <li>1756-L74: 16 MB</li> <li>1756-L75: 32 MB</li> </ul>	<ul style="list-style-type: none"> <li>1769-L30ER, 1769-L30ER-NSE, 1769-L30ERM: 1MB</li> <li>1769-L33ER, 1769-L33ERM: 2 MB</li> <li>1769-L36ERM: 3 MB</li> </ul>	<ul style="list-style-type: none"> <li>1769-L24ER: 750 KB</li> <li>1769-L27ERM: 1 MB</li> </ul>	<ul style="list-style-type: none"> <li>1769-L16ER: 384 KB</li> <li>1769-L18ER, 1769-L18ERM: 512 KB</li> </ul>	<ul style="list-style-type: none"> <li>1768-L43: 2 MB</li> <li>1768-L43S: 2 MB + 0.5 MB safety</li> <li>1768-L45: 3 MB</li> <li>1768-L45S: 3 MB + 1 MB safety</li> </ul>
Memory card	Secure Digital	Secure Digital	Secure Digital	Secure Digital	CompactFlash
Built-in ports	1 USB	2 EtherNet/IP 1 USB	2 EtherNet/IP 1 USB	2 EtherNet/IP 1 USB	1 RS-232
Communication options	<ul style="list-style-type: none"> <li>EtherNet/IP (standard and safety)</li> <li>ControlNet (standard and safety)</li> <li>DeviceNet (standard and safety)</li> <li>DH+</li> <li>Remote I/O</li> <li>SynchLink</li> </ul>	<ul style="list-style-type: none"> <li>Dual-port EtherNet/IP<sup>(1)</sup></li> <li>DeviceNet</li> </ul>	<ul style="list-style-type: none"> <li>Dual-port EtherNet/IP<sup>(1)</sup></li> <li>DeviceNet</li> </ul>	<ul style="list-style-type: none"> <li>Dual-port EtherNet/IP<sup>(1)</sup></li> </ul>	<ul style="list-style-type: none"> <li>EtherNet/IP (standard and safety)</li> <li>ControlNet (standard and safety)</li> <li>DeviceNet (standard)</li> </ul>
Controller connections	500	256	256	256	250
Network connections	Per module: <ul style="list-style-type: none"> <li>128 ControlNet (CN2/B)</li> <li>40 ControlNet (CNB)</li> <li>256 EtherNet/IP; 128 TCP (EN2x)</li> <li>128 EtherNet/IP; 64 TCP (ENBT)</li> </ul>	<ul style="list-style-type: none"> <li>1769-L30ER, 1769-L30ER-NSE, 1769-L30ERM: 256 EtherNet/IP; 120 TCP</li> <li>1769-L33ER, 1769-L33ERM: 256 EtherNet/IP; 120 TCP</li> <li>1769-L36ERM: 256 EtherNet/IP; 120 TCP</li> </ul>	<ul style="list-style-type: none"> <li>1769-L24ER: 256 EtherNet/IP; 120 TCP</li> <li>1769-L27ERM: 256 EtherNet/IP; 120 TCP</li> </ul>	<ul style="list-style-type: none"> <li>1769-L16ER: 256 EtherNet/IP; 120 TCP</li> <li>1769-L18ER, 1769-L18ERM: 256 EtherNet/IP; 120 TCP</li> </ul>	Per module: <ul style="list-style-type: none"> <li>48 ControlNet</li> <li>128 EtherNet/IP; 64 TCP</li> </ul>
EtherNet/IP nodes in a single Logix Designer application, max	N/A	<ul style="list-style-type: none"> <li>1769-L30ER, 1769-L30ER-NSE, 1769-L30ERM: 16</li> <li>1769-L33ER, 1769-L33ERM: 32</li> <li>1769-L36ERM: 48</li> </ul>	<ul style="list-style-type: none"> <li>1769-L24ER: 8</li> <li>1769-L27ERM: 16</li> </ul>	<ul style="list-style-type: none"> <li>1769-L16ER: 4</li> <li>1769-L18ER, 1769-L18ERM: 8</li> </ul>	N/A
Controller redundancy	Full support	Backup via DeviceNet	Backup via DeviceNet	—	Backup via DeviceNet
Integrated motion	<ul style="list-style-type: none"> <li>Integrated motion on an EtherNet/IP network</li> <li>SERCOS interface</li> <li>Analog options</li> </ul>	Integrated motion on an EtherNet/IP network	Integrated motion on an EtherNet/IP network	Integrated motion on an EtherNet/IP network	SERCOS interface
Programming languages	<ul style="list-style-type: none"> <li>Standard task: all languages</li> <li>Safety task: relay ladder, safety application instructions</li> </ul>	<ul style="list-style-type: none"> <li>Relay ladder</li> <li>Structured text</li> <li>Function block</li> <li>SFC</li> </ul>	<ul style="list-style-type: none"> <li>Relay ladder</li> <li>Structured text</li> <li>Function block</li> <li>SFC</li> </ul>	<ul style="list-style-type: none"> <li>Relay ladder</li> <li>Structured text</li> <li>Function block</li> <li>SFC</li> </ul>	<ul style="list-style-type: none"> <li>Standard task: all languages</li> <li>Safety task: relay ladder, safety application instructions</li> </ul>

(1) CompactLogix™ 5370 controllers have two EtherNet/IP ports to connect to an EtherNet/IP network. The ports carry the same network traffic as part of the controller's embedded switch. The controller uses only one IP address.

# Select a CompactLogix System

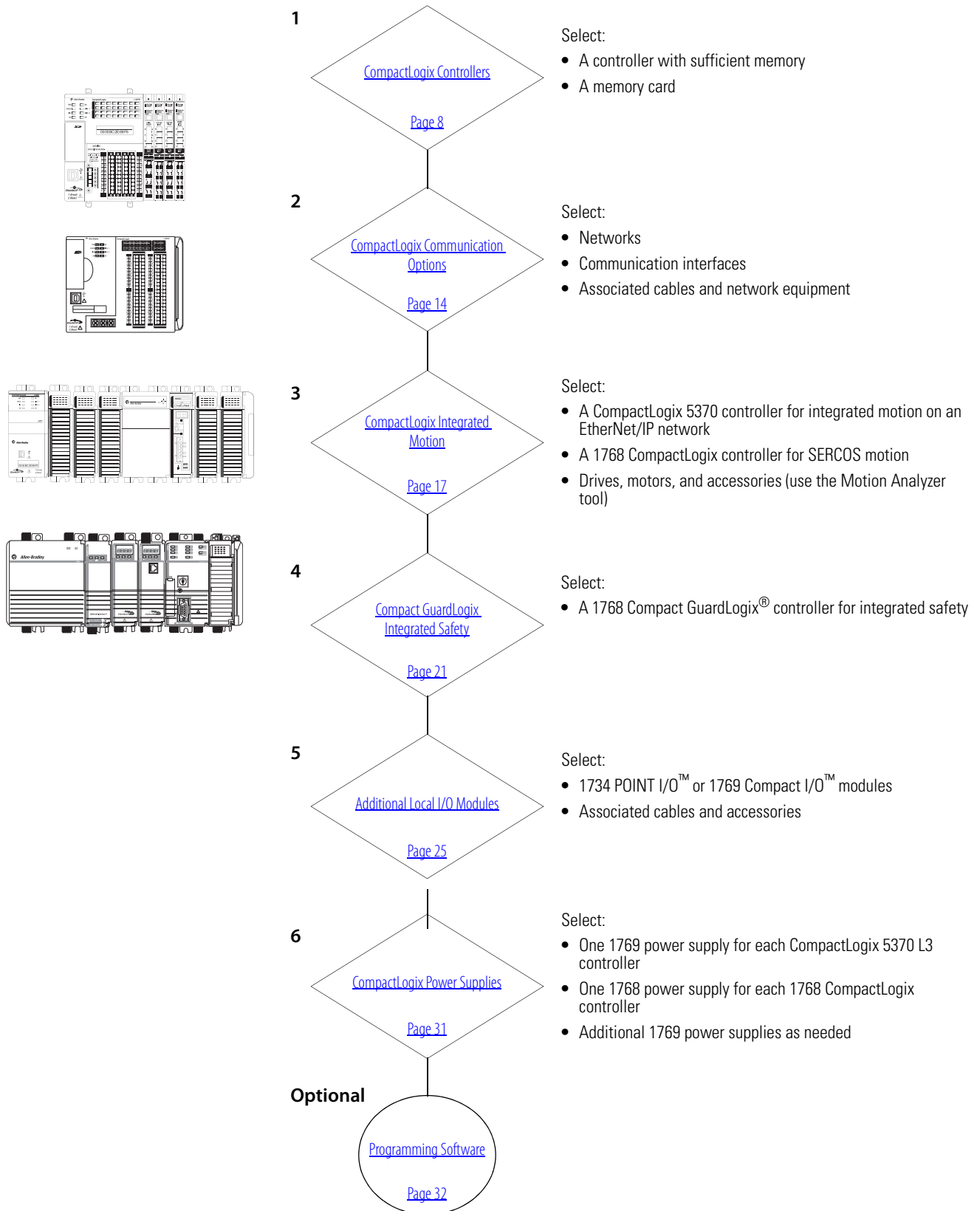

## CompactLogix Controllers Overview

The CompactLogix system is designed to provide a Logix solution for small and mid-size applications. Typically, these applications are machine-level control applications. A simple system can consist of a standalone controller with one bank of I/O modules and DeviceNet communication. In a more complex system, add other networks, motion control, and safety control. As part of the Integrated Architecture™ system, the CompactLogix controllers use the same programming software, network protocol, and information capabilities as all Logix controllers, providing a common development environment for all control disciplines.

- The CompactLogix 5370 L3 controllers deliver scalable, affordable control ideal for applications from small standalone equipment to high-performance indexing tables, process skids, case packers and erectors, and packaging. The CompactLogix 5370 L3 controllers also provide a truly integrated motion solution.
- The CompactLogix 5370 L2 controllers combine the power of the Logix architecture with the flexibility of Compact I/O modules. From small standalone equipment to higher performance applications, these controllers are ideal for assembly machines, hoisting systems, process skids, indexing tables, and packaging.
- The CompactLogix 5370 L1 controllers combine the power of the Logix architecture with the flexibility of POINT I/O. Ideal for small to mid-size machines, these controllers offer value to customers looking for the benefits of Integrated Architecture in a lower cost system.

### CompactLogix 5370 System on an EtherNet/IP Network

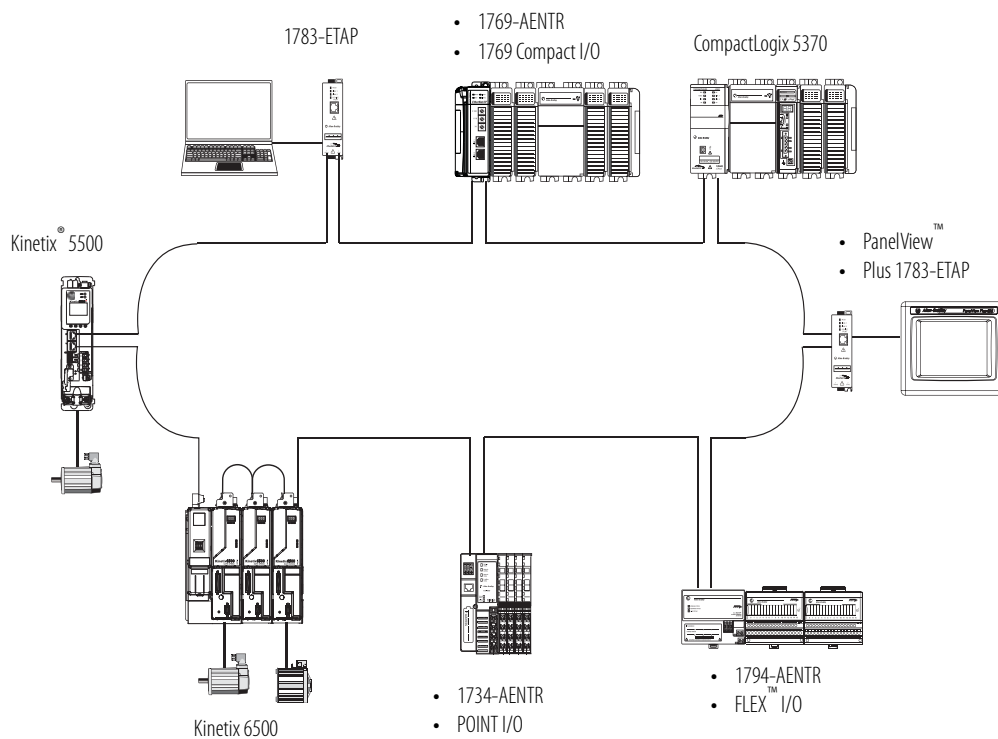

The CompactLogix 5370 L2 and L3 controllers support DeviceNet connectivity.

### CompactLogix 5370 System on an DeviceNet Network

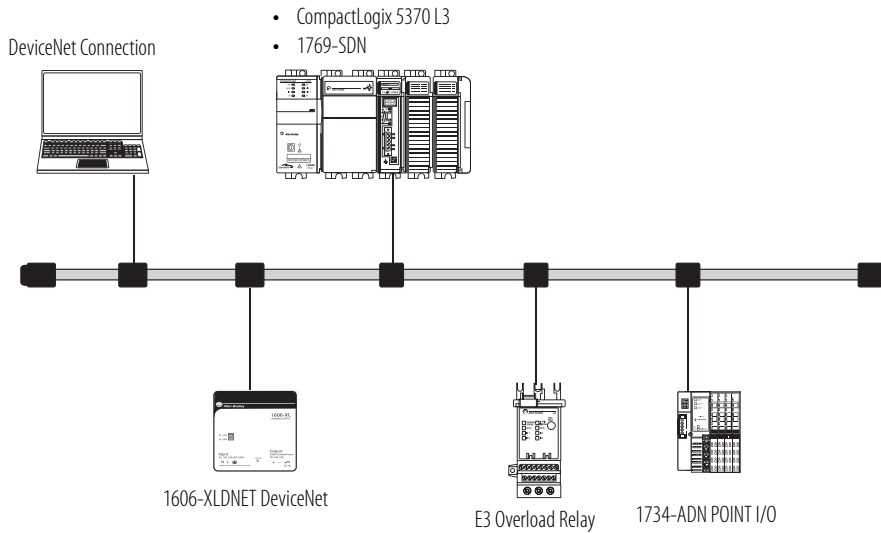

### 1768 CompactLogix System

Important: 1768 controllers are compatible with only version 20 or earlier of the RSLogix 5000 software.

The 1768 CompactLogix system combines a 1768 backplane for communication and motion support and a 1769 backplane for I/O support. The 1768 controller is designed for integrated motion, integrated safety, and more complex communication requirements than the other CompactLogix controllers. The 1768 controller has one serial port. Add 1768 modules for motion control, EtherNet/IP communication, and ControlNet communication.

### 1768 CompactLogix System on an EtherNet/IP Network

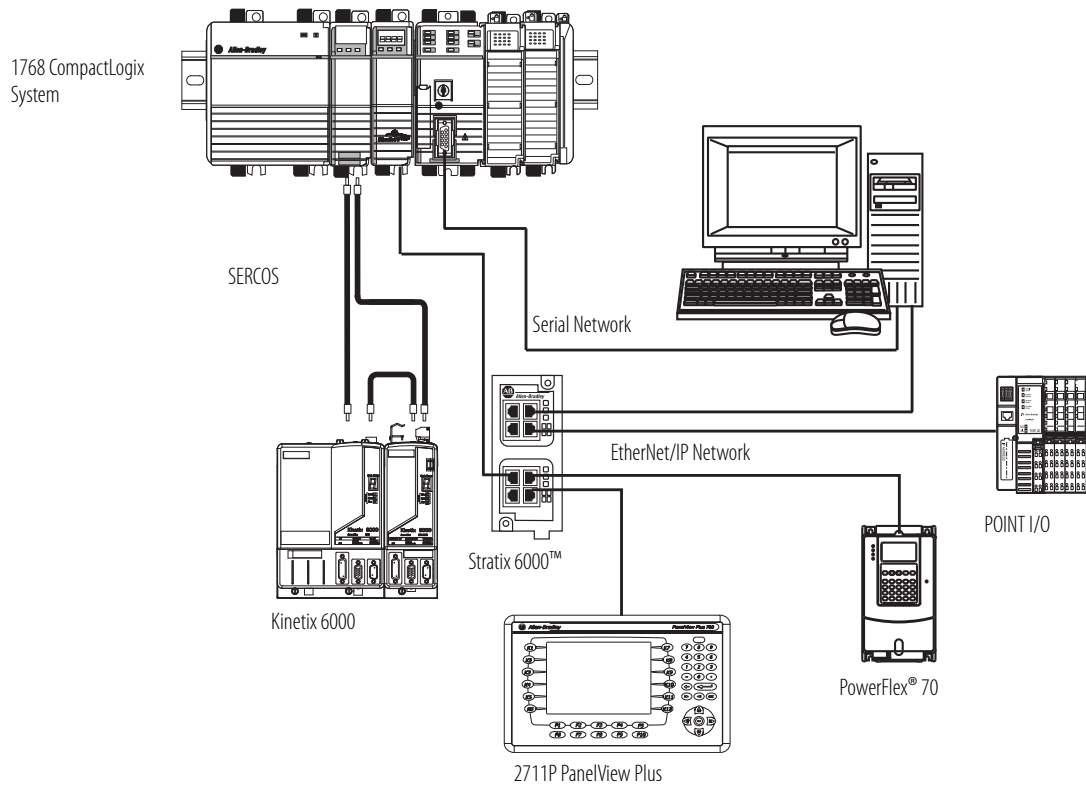

### 1768 Compact GuardLogix Safety System

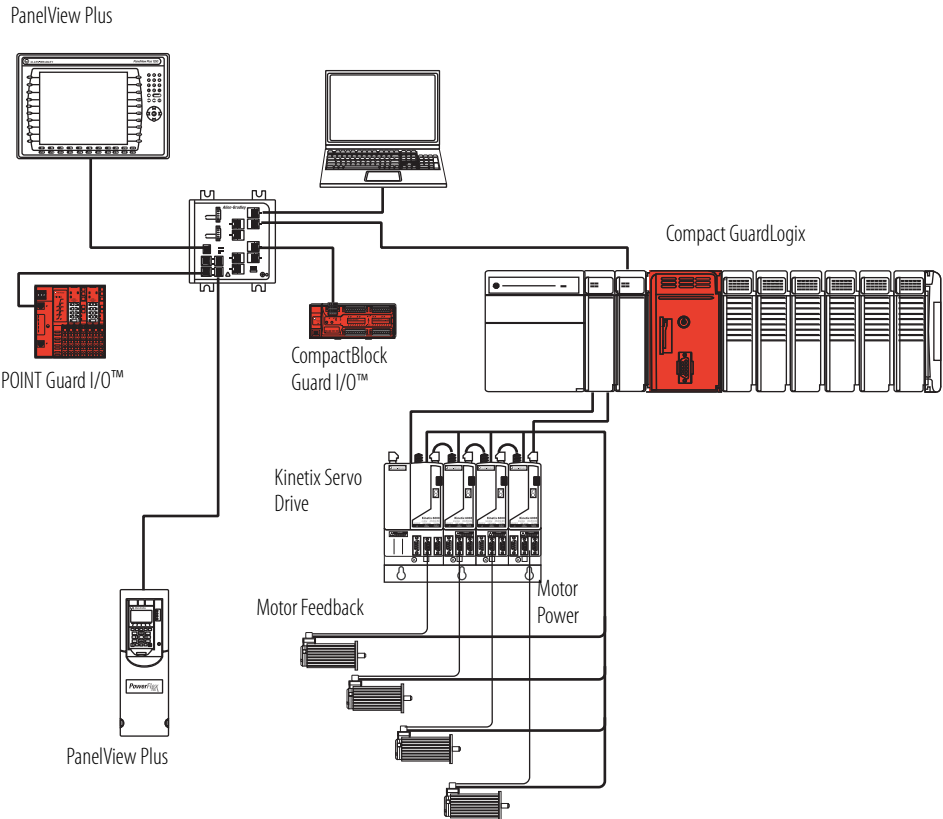

# CompactLogix Controllers

The CompactLogix platform brings together the benefits of the Logix platform— common programming environment, common networks, common control engine—in a small footprint with high performance. Combined with Compact I/O modules, the CompactLogix platform is perfect for tackling smaller, machine-level control applications, with or without simple motion, with unprecedented power and scalability. A CompactLogix platform is ideal for systems that require standalone and system-connected control over EtherNet/IP, ControlNet, or DeviceNet networks.



For detailed specifications, see CompactLogix Controllers Specifications Technical Data, publication [1769-TD005](#).

Characteristic	CompactLogix 5370 L1 Controllers	CompactLogix 5370 L2 Controllers	CompactLogix 5370 L3 Controllers	1768 Controllers <sup>(1)</sup>
Controller application	Small applications Embedded 1734 I/O modules	Small applications Embedded 1769 I/O modules	General purpose	Integrated safety Integrated SERCOS motion
Controller tasks	32; 100 programs/task	32; 100 programs/task	32; 100 programs/task	<ul style="list-style-type: none"> <li>1768-L43: 16; 32 programs/task</li> <li>1768-L45: 30; 32 programs/task</li> </ul>
Event tasks	Consumed tag, EVENT instruction, embedded inputs, remote I/O, axis, and motion event triggers	Consumed tag, EVENT instruction, remote I/O, axis, and motion event triggers	Consumed tag, EVENT instruction, remote I/O, axis, and motion event triggers	Consumed tag, EVENT instruction, remote I/O, axis, and motion event triggers
User memory	<ul style="list-style-type: none"> <li>1769-L16ER-BB1B: 384 KB</li> <li>1769-L18ER-BB1B, 1769-L18ERM-BB1B: 512 KB</li> </ul>	<ul style="list-style-type: none"> <li>1769-L24ER-QB1B, 1769-L24ER-QBFC1B: 750 KB</li> <li>1769-L27ERM-QBFC1B: 1 MB</li> </ul>	<ul style="list-style-type: none"> <li>1769-L30ER, 1769-L30ERM, 1769-L30ER-NSE: 1MB</li> <li>1769-L33ER, 1769-L33ERM: 2 MB</li> <li>1769-L36ERM: 3 MB</li> </ul>	<ul style="list-style-type: none"> <li>1768-L43: 2 MB</li> <li>1768-L43S: 2 MB + 0.5 MB safety</li> <li>1768-L45: 3 MB</li> <li>1768-L45S: 3 MB + 1 MB safety</li> </ul>
Built-in ports	<ul style="list-style-type: none"> <li>2 EtherNet/IP<sup>(2)</sup></li> <li>1 USB</li> </ul>	<ul style="list-style-type: none"> <li>2 EtherNet/IP<sup>(2)</sup></li> <li>1 USB</li> </ul>	<ul style="list-style-type: none"> <li>2 EtherNet/IP<sup>(2)</sup></li> <li>1 USB</li> </ul>	<ul style="list-style-type: none"> <li>1 port RS-232 serial (DF1 or ASCII)</li> </ul>
Communication options	<ul style="list-style-type: none"> <li>Dual-port EtherNet/IP</li> </ul>	<ul style="list-style-type: none"> <li>Dual-port EtherNet/IP</li> <li>DeviceNet</li> </ul>	<ul style="list-style-type: none"> <li>Dual-port EtherNet/IP</li> <li>DeviceNet</li> </ul>	<ul style="list-style-type: none"> <li>EtherNet/IP (standard and safety)</li> <li>ControlNet (standard and safety)</li> <li>DeviceNet (standard)</li> </ul>

(1) 1768 controllers are compatible with only version 20 or earlier of the RSLogix 5000 software.

(2) CompactLogix 5370 controllers have two EtherNet/IP ports to connect to an EtherNet/IP network. The ports carry the same network traffic as part of the controller's embedded switch. The controller uses only one IP address.

For information on estimating memory requirements for your application, see Logix5000 Controllers Execution Time and Memory Use Reference Manual, publication [1756-RM087](#).



## CompactLogix 5370 L1 Controllers with Embedded POINT I/O Modules

The CompactLogix 5370 L1 controller comes with:

- a built-in, 24V DC nonisolated power supply.<sup>(1)</sup>
- dual EtherNet/IP ports for ring topologies.
- USB port for firmware download and programming.
- embedded digital I/O (16 DC inputs, 16 DC outputs).



Characteristic	1769-L16ER-BB1B	1769-L18ER-BB1B	1769-L18ERM-BB1B
Available user memory	384 KB	512 KB	512 KB
Memory card	<ul style="list-style-type: none"> <li>• 1784-SD1 (1 GB), shipped with controller</li> <li>• 1784-SD2 (2 GB)</li> </ul>		
Communication ports	<ul style="list-style-type: none"> <li>• 2 EtherNet/IP</li> <li>• 1 USB</li> </ul>		
Embedded I/O	<ul style="list-style-type: none"> <li>• 16 sinking 24V DC digital input points</li> <li>• 16 sourcing 24V DC digital output points</li> </ul>		
EtherNet/IP connections	<ul style="list-style-type: none"> <li>• 256 EtherNet/IP</li> <li>• 120 TCP</li> </ul>	<ul style="list-style-type: none"> <li>• 256 EtherNet/IP</li> <li>• 120 TCP</li> </ul>	<ul style="list-style-type: none"> <li>• 256 EtherNet/IP</li> <li>• 120 TCP</li> </ul>
EtherNet/IP nodes in one Logix Designer application, max	4	8	
Integrated motion on an EtherNet/IP network	—	—	Supports up to 2 axes
Module expansion capacity	6 POINT I/O modules	8 POINT I/O modules	8 POINT I/O modules
Battery	None		
Embedded power supply	10...28.8V DC 24V DC nominal		
Programming software support	<ul style="list-style-type: none"> <li>• RSLogix™ 5000 software, version 20 - For controllers that use firmware revision 20.xxx.</li> <li>• Logix Designer application, version 21 or later - For controllers that use firmware revision 21.xxx or later.</li> </ul>		

(1) For more information on connecting a 24V DC power source to the CompactLogix 5370 L1 controller's 24V DC nonisolated power supply, see the CompactLogix 5370 Controllers User Manual, publication [1769-UM021](#).

## CompactLogix 5370 L2 Controllers with Embedded Compact I/O Modules



The CompactLogix 5370 L2 controller comes with:

- a built-in, 24V DC power supply.
- dual EtherNet/IP ports for ring topologies.
- USB port for firmware download and programming.
- a combination of embedded digital, analog, and high-speed counter I/O.
- a 1769-ECR right-end cap.

Characteristic	1769-L24ER-QB1B	1769-L24ER-QBFC1B	1769-L27ERM-QBFC1B
Available user memory	0.75 MB	0.75 MB	1 MB
Memory card	<ul style="list-style-type: none"> <li>• 1784-SD1 (1 GB), shipped with controller</li> <li>• 1784-SD2 (2 GB)</li> </ul>		
Communication ports	<ul style="list-style-type: none"> <li>• 2 EtherNet/IP</li> <li>• 1 USB</li> </ul>		
Embedded I/O	<ul style="list-style-type: none"> <li>• 16 sinking/sourcing 24V DC digital input points</li> <li>• 16 sourcing 24V DC digital output points</li> </ul>	<ul style="list-style-type: none"> <li>• 16 sinking/sourcing 24V DC digital input points</li> <li>• 16 sourcing 24V DC digital output points</li> <li>• 4 universal analog input points</li> <li>• 2 analog output points</li> <li>• 4 high-speed counters</li> </ul>	
EtherNet/IP connections	<ul style="list-style-type: none"> <li>• 256 EtherNet/IP</li> <li>• 120 TCP</li> </ul>	<ul style="list-style-type: none"> <li>• 256 EtherNet/IP</li> <li>• 120 TCP</li> </ul>	<ul style="list-style-type: none"> <li>• 256 EtherNet/IP</li> <li>• 120 TCP</li> </ul>
EtherNet/IP nodes in one Logix Designer application, max	8		16
Integrated motion on an EtherNet/IP network	—	—	Supports up to 4 axes
Module expansion capacity	4 1769 modules		
Battery	None		
Embedded power supply	24V DC		
Programming software support	<ul style="list-style-type: none"> <li>• RSLogix 5000 software, version 20 - For controllers that use firmware revision 20.xxx.</li> <li>• Logix Designer application, version 21 or later - For controllers that use firmware revision 21.xxx or later.</li> </ul>		

These controllers replace previous catalog numbers.

New Controller	Replaces Previous Controller <sup>(1)</sup>	Differences
1769-L24ER-QBFC1B	1769-L23-QBFC1B 1769-L23E-QBFC1B	<ul style="list-style-type: none"> <li>• Additional memory</li> <li>• Integrated motion on EtherNet/IP support (1769-L27ERM-QBFC1B)</li> <li>• USB port instead of RS-232 port</li> <li>• Dual-port EtherNet/IP support</li> <li>• SD card support addition</li> <li>• Support for additional expansion I/O modules</li> </ul>
1769-L24ER-QB1B	1769-L23E-QB1B	
1769-L27ERM-QBFC1B	1769-L23E-QBFC1B	

(1) These catalog numbers are still available for sale, see [page 12](#) for details. Please contact your local Rockwell Automation sales office for ordering information.

## CompactLogix 5370 L3 Controllers

In a CompactLogix 5370 L3 controller system, the 1769 I/O modules can be placed to the left and the right of the power supply. As many as eight modules can be placed on each side of the power supply. The CompactLogix 5370 L3 controller comes with:



- dual EtherNet/IP ports for ring topologies.
- USB port for firmware download and programming.

Characteristic	1769-L30ER	1769-L30ERM	1769-L30ER-NSE	1769-L33ER	1769-L33ERM	1769-L36ERM
Available user memory	1 MB	1 MB	1 MB No capacitor	2 MB	2 MB	3 MB
Memory card	1784-SD1 (1 GB), shipped with controller 1784-SD2 (2 GB)					
Communication ports	<ul style="list-style-type: none"> <li>• 2 EtherNet/IP</li> <li>• 1 USB</li> </ul>					
EtherNet/IP connections	<ul style="list-style-type: none"> <li>• 256 EtherNet/IP</li> <li>• 120 TCP</li> </ul>	<ul style="list-style-type: none"> <li>• 256 EtherNet/IP</li> <li>• 120 TCP</li> </ul>	<ul style="list-style-type: none"> <li>• 256 EtherNet/IP</li> <li>• 120 TCP</li> </ul>	<ul style="list-style-type: none"> <li>• 256 EtherNet/IP</li> <li>• 120 TCP</li> </ul>	<ul style="list-style-type: none"> <li>• 256 EtherNet/IP</li> <li>• 120 TCP</li> </ul>	<ul style="list-style-type: none"> <li>• 256 EtherNet/IP</li> <li>• 120 TCP</li> </ul>
EtherNet/IP nodes in one Logix Designer application, max	16			32		48
Integrated motion on an EtherNet/IP network	—	Supports up to 4 axes	—	—	Supports up to 8 axes	Supports up to 16 axes
Module expansion capacity	8 1769 modules 1 bank of modules			16 1769 modules 2 banks of modules		30 1769 modules 3 banks of modules
Battery	None					
Power supply distance rating	4 modules			4 modules		4 modules
Programming software support	<ul style="list-style-type: none"> <li>• RSLogix 5000 software, version 20 - For controllers that use firmware revision 20.xxx.</li> <li>• Logix Designer application, version 21 or later - For controllers that use firmware revision 21.xxx or later.</li> </ul>					

These controllers replace previous catalog numbers.

New Controller <sup>(1)</sup>	Replaces Previous Controller <sup>(2)</sup>	Differences
1769-L30ER	1769-L31	<ul style="list-style-type: none"> <li>• Additional memory</li> <li>• Integrated motion on EtherNet/IP support (1769-L30ERM, 1769-L33ERM, 1769-L36ERM)</li> <li>• USB port instead of RS-232 port</li> <li>• Dual-port EtherNet/IP support</li> <li>• SD card instead of CompactFlash card</li> </ul>
1769-L30ERM	1769-L32C <sup>(3)</sup>	
1769-L30ER-NSE	1769-L32E	
1769-L33ER	1769-L35CR <sup>(3)</sup>	
1769-L33ERM	1769-L35E	
1769-L36ERM	Any previous 1769-L3x controller	

(1) IMPORTANT: Typically, you can use any of the new controllers listed in each row as replacements for any of the previous controllers listed in the corresponding cell to the right. For example, you can replace a 1769-L32E with a 1769-L30ER, 1769-L30ERM, or 1769-L30ER-NSE controller.

In some rare cases, system configuration prevents controller replacement as shown above. For example, if your system uses a 1769-L32E controller with 12 expansion modules, you cannot replace that controller with a 1769-L30ER, 1769-L30ERM, or 1769-L30ER-NSE controller. Those controllers support no more than 8 expansion modules. You must replace the 1769-L32E controller with a 1769-L33ER, 1769-L33ERM, or 1769-L36ERM controller.

We recommend that before you upgrade your controllers, consider your application requirements to verify that the replacements listed above apply.

(2) These catalog numbers are still available for sale, see [page 13](#) for details. Please contact your local Rockwell Automation sales office for ordering information.

(3) Requires converting from ControlNet connections to EtherNet/IP connections.

## 1768 CompactLogix Controllers

The 1768 CompactLogix controller combines a 1768 backplane and a 1769 backplane. The 1768 backplane supports the 1768 controller, the 1768 power supply, and a maximum of four 1768 modules. The 1769 backplane supports 1769 modules.

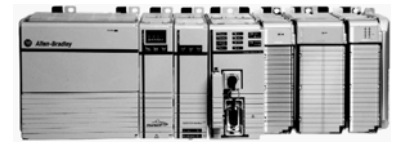

Characteristic	1768-L43	1768-L43S	1768-L45	1768-L45S
Available user memory	2 MB	2 MB standard 0.5 MB safety	3 MB	3 MB standard 1 MB safety
Memory card	1784-CF128 (128 MB)			
Communication options	<ul style="list-style-type: none"> <li>• EtherNet/IP (standard and safety)</li> <li>• ControlNet (standard and safety)</li> <li>• DeviceNet (standard)</li> </ul>			
Serial communication port	1 RS-232 port			
Number of 1768 modules, max	2		4	
Number of 1769 I/O modules, max	16		30	
Number of I/O banks, max	2		3	
Battery	None			
Programming software support	RSLogix 5000 software, version 20 or earlier			

## 1769-L23x Packaged CompactLogix Controllers with Embedded I/O

The 1769-L23x controllers provide the following functionality:

- Built-in power supply
- Two serial ports or one serial and one EtherNet/IP port, depending on controller catalog number
- Combination of embedded digital, analog, and high-speed counter I/O modules
- 1769-ECR right-end cap

Characteristic	1769-L23-QBFC1B	1769-L23E-QB1B	1769-L23E-QBFC1B
Available user memory	512 KB	512 KB	512 KB
CompactFlash card	None		
Communication ports	2 RS-232 ports (isolated DF1 or ASCII; only nonisolated DF1)	1 EtherNet/IP port 1 RS-232 serial port (DF1 or ASCII)	1 EtherNet/IP port 1 RS-232 serial port (DF1 or ASCII)
Embedded I/O	<ul style="list-style-type: none"> <li>• 16 DC inputs</li> <li>• 16 DC outputs</li> <li>• 4 analog inputs</li> <li>• 2 analog outputs</li> <li>• 4 high-speed counters</li> </ul>	<ul style="list-style-type: none"> <li>• 16 DC inputs</li> <li>• 16 DC outputs</li> </ul>	<ul style="list-style-type: none"> <li>• 16 DC inputs</li> <li>• 16 DC outputs</li> <li>• 4 analog inputs</li> <li>• 2 analog outputs</li> <li>• 4 high-speed counters</li> </ul>
Module expansion capacity	2 1769 modules	3 1769 modules	2 1769 modules
Embedded power supply	24V DC		
Programming software support	RSLogix 5000 software, version 20 or earlier		

## 1769-L3x Modular CompactLogix Controllers

In a 1769-L3x controller system, the 1769 I/O modules can be placed to the left and the right of the power supply. As many as eight modules can be placed on each side of the power supply.

Characteristic	1769-L31	1769-L32C	1769-L32E	1769-L35CR	1769-L35E
Available user memory	512 KB	750 KB	750 KB	1.5 MB	1.5 MB
CompactFlash card	1784-CF128				
Communication ports	2 RS-232 ports (isolated DF1 or ASCII; only nonisolated DF1)	1 ControlNet port 1 RS-232 port (DF1 or ASCII)	1 EtherNet/IP port 1 RS-232 port (DF1 or ASCII)	1 ControlNet port 1 RS-232 port (DF1 or ASCII)	1 EtherNet/IP port 1 RS-232 port (DF1 or ASCII)
Module expansion capacity	16 1769 modules			30 1769 modules	
Power supply distance rating	4 modules				
Programming software support	RSLogix 5000 software, version 20 or earlier				

## Controller Memory Use

These equations provide an estimate of the memory needed for a CompactLogix controller. These numbers are rough estimates.

<b>Controller tasks</b>	_____ * 4000	=	_____ bytes (minimum 1 task)
Digital I/O points	_____ * 400	=	_____ bytes
Analog I/O points	_____ * 2600	=	_____ bytes
DeviceNet modules <sup>(1)</sup>	_____ * 7400	=	_____ bytes
Other communication modules <sup>(2)</sup>	_____ * 2000	=	_____ bytes
Motion axes	_____ * 8000	=	_____ bytes
FactoryTalk <sup>®</sup> alarm instruction	_____ * 1000	=	_____ bytes (per alarm)
FactoryTalk subscriber	_____ * 10000	=	_____ bytes

(1) The first DeviceNet module is 7400 bytes. Additional DeviceNet modules are 5800 bytes each.

(2) Count the communication modules in the system, not just those in the local chassis. This includes device connection modules, adapter modules, and ports on PanelView terminals.

Reserve 20...30% of the controller memory for future expansion.

# CompactLogix Communication Options

You can configure your system for information exchange between a range of devices and computing platforms and operating systems. Select a CompactLogix controller with integrated communication or the appropriate communication module.

For detailed specifications, see:

- CompactLogix Controllers Specifications Technical Data, publication [1769-TD005](#).
- CompactLogix Communication Modules Specifications Technical Data, publication [1769-TD007](#).

## EtherNet/IP Communication Options

The Ethernet Industrial network protocol (EtherNet/IP) is an open industrial-networking standard that supports real-time I/O messaging and message exchange. The EtherNet/IP network uses off-the-shelf Ethernet communication chips and physical media.

Dual-port EtherNet/IP support embeds switch technology directly in the controller to so the controller can operate on star, linear, or ring EtherNet/IP topologies.

Cat. No.	Description	Communication Rate	Logix Resources <sup>(1)</sup>	TCP/IP Connections
1769-L16ER-BB1B,	CompactLogix 5370 L1 controller with integrated EtherNet/IP dual-port, POINT I/O form factor	10/100 Mbps	4 nodes 256 EtherNet/IP connections	120
1769-L18ER-BB1B, 1769-L18ERM-BB1B			8 nodes 256 EtherNet/IP connections	
1769-L24ER-BB1B, 1769-L24ER-QBFC1B	CompactLogix 5370 L2 controller with integrated EtherNet/IP dual-port, Compact I/O form factor	10/100 Mbps	8 nodes 256 EtherNet/IP connections	120
1769-L27ERM-QBFC1B		10/100 Mbps	16 nodes 256 EtherNet/IP connections	
1769-L30ER, 1769-L30ERM	CompactLogix 5370 L3 controller with integrated EtherNet/IP dual-port	10/100 Mbps	16 nodes 256 EtherNet/IP connections	120
1769-L33ER, 1769-L33ERM			32 nodes 256 EtherNet/IP connections	
1769-L36ERM			48 nodes 256 EtherNet/IP connections	
1769-AENTR	1769 EtherNet/IP adapter	10/100 Mbps	128 EtherNet/IP connections	96
1768-ENBT	1768 EtherNet/IP communication bridge module	10/100 Mbps	128 EtherNet/IP connections	64
1768-EWEB	1768 Ethernet web server module	10/100 Mbps	128 EtherNet/IP connections	64

(1) The number of nodes listed for CompactLogix 5370 controllers represents the maximum number of EtherNet/IP nodes you can include in a Logix Designer application project for those controller. For example, in a Logix Designer application project that uses a 1769-L18ERM-BB1B controller, you can add as many as 8 EtherNet/IP nodes to the project.

## ControlNet Communication Options for 1768 CompactLogix Controllers

The ControlNet network is an open, control network for real-time, high-throughput applications. The ControlNet network uses the Common Industrial Protocol (CIP) to combine the functionality of an I/O network and a peer-to-peer network providing high-speed performance. The ControlNet network gives you deterministic, repeatable transfers of all mission-critical control data and supporting transfers of non-time-critical data. I/O updates and controller-to-controller interlocking take precedence over program uploads and downloads and messaging.

Cat. No.	Description	Communication Rate	Logix Connections
1768-CN8	1768 CompactLogix controller, ControlNet communication bridge module, single media	5 Mbps	48
1768-CNBR	1768 CompactLogix controller, ControlNet communication bridge module, redundant media	10/100 Mbps	48

### 1768 CompactLogix Controllers on a ControlNet Network

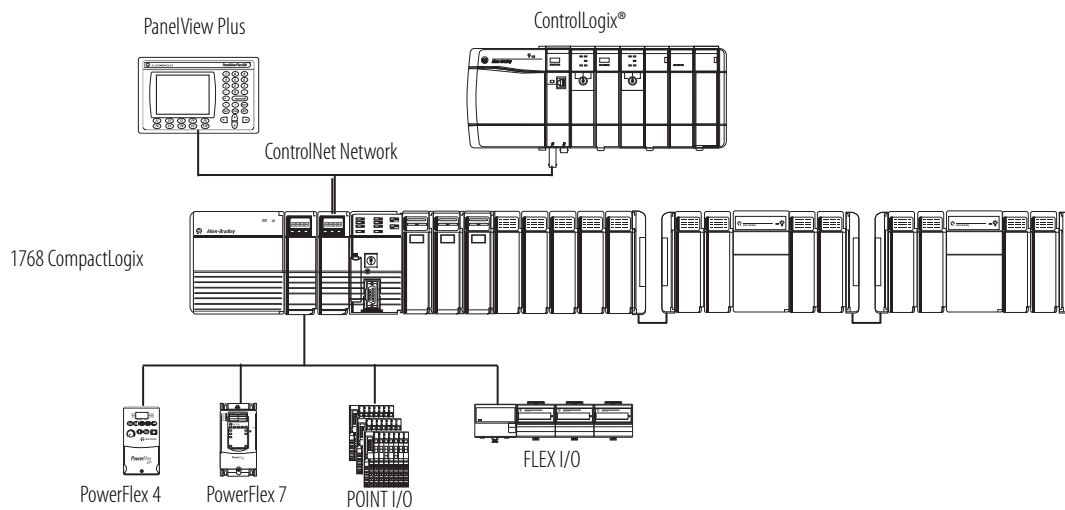

## DeviceNet Communication Options

The DeviceNet network is an open, low-level network that provides connections between simple industrial devices (such as sensors and actuators) and higher-level devices (such as controllers and computers).

Cat. No.	Description	Communication Rate	Number of Nodes
1769-SDN	Compact I/O DeviceNet scanner module	125 Kbps (500 m max) 250 Kbps (250 m max)	64
1769-ADN	Compact I/O DeviceNet adapter module	500 Kbps (100 m max)	

## Serial Communication Options

These CompactLogix controllers support serial communication.

Cat. No.	Serial Options
1769-L16ER-BB1B, 1769-L18ER-BB1B, 1769-L18ERM-BB1B	1734-232ASC module for an RS-232 serial interface 1734-485 ASC module for an RS-422 and RS-485 serial device
1769-L24ER-BB1B, 1769-L24ER-QBFC1B	1769-ASCII module for an ASCII interface to RS-232, RS-422, and RS-485 devices
1769-L27ERM-QBFC1B	1769-SM2 module for a Modbus RTU interface
1769-L30ER, 1769-L30ERM	
1769-L33ER, 1769-L33ERM	
1769-L36ERM	
1768-L43, 1768-L43S, 1768-L45, 1768-L45S	Built-in serial port 1769-ASCII module for an ASCII interface to RS-232, RS-422, and RS-485 devices 1769-SM2 module for a Modbus RTU interface

## Modbus Support

To access a Modbus TCP network, connect through the embedded Ethernet port of the CompactLogix 5370 controllers and execute a ladder-logic routine. For more information, see Knowledgebase document 470365 at <http://www.rockwellautomation.com/knowledgebase/>.

To access a Modbus RTU network, connect through the serial port (if available) and execute a ladder-logic routine. For more information, see Using Logix5000 Controllers as Masters or Slaves on Modbus Application Solution, publication [CIG-AP129](#).



# CompactLogix Integrated Motion

The Logix architecture supports motion control components that work in a wide variety of machine architectures.

- Integrated motion on EtherNet/IP supports a connection to Ethernet drives.
- The Kinetix integrated-motion solution uses a SERCOS interface module to perform multi-axis, synchronized motion.
- Logix integrated motion supports the analog family of servo modules for controlling drives/actuators.
- Networked motion provides the ability to connect via the DeviceNet network to one axis drive to perform point-to-point indexing.

Motion Feature	CompactLogix 5370 L3	CompactLogix 5370 L2	CompactLogix 5370 L1	1768-L43, 1768-L43S CompactLogix and Compact GuardLogix	1768-L45, 1768-L45S CompactLogix and Compact GuardLogix
EtherNet/IP sequence of events for software registration	Yes	Yes	Yes	Yes	Yes
Kinematics	Yes	Yes	Yes	No	No
Integrated motion on an EtherNet/IP network	Yes <sup>(1)</sup>	Yes <sup>(2)</sup>	Yes <sup>(3)</sup>	No	No
Indexing	Yes with AMCI 1769-3602 pulse-train output module	Yes with AMCI 1769-3602 pulse-train output module	Yes with one of these pulse-train output modules: <ul style="list-style-type: none"> <li>• AMCI 1734-3401</li> <li>• AMCI 1734-3401L</li> </ul>	—	—
Load observer (with only Kinetix 6500 drives)	Yes	Yes	Yes	No	No
Total axis count	100	100	100	12 <ul style="list-style-type: none"> <li>• 4 position</li> <li>• 2 feedback</li> <li>• 6 virtual</li> </ul>	16 <ul style="list-style-type: none"> <li>• 8 position</li> <li>• 2 feedback</li> <li>• 6 virtual</li> </ul>
Virtual axis, max.	100	100	100	6	6
EtherNet/IP axis, max.	16	4	2	None	None
EtherNet/IP feedback, VHz, torque, or velocity axis, max.	48	16	8	None	None

(1) In the CompactLogix 5370 L3 controller family, only the 1769-L30ERM, 1769-L33ERM, 1769-L36ERM controllers support Integrated Motion on an EtherNet/IP network.

(2) In the CompactLogix 5370 L2 controller family, only the 1769-L27ERM-QBFC1B controller supports Integrated Motion on an EtherNet/IP network.

(3) In the CompactLogix 5370 L1 controller family, only the 1769-L18ERM-BB1B controller supports Integrated Motion on an EtherNet/IP network.

For more information, see the:

- Motion Analyzer CD to size your motion application and to make final component selection. Download the software from <http://www.ab.com/motion/software/analyzer.html>.
- Kinetix Motion Control Selection Guide, publication [GMC-SG001](#), to verify drive, motor, and accessory specifications.

Some CompactLogix 5370 controllers support integrated motion on an EtherNet/IP network. Select the controller with sufficient axis-support for your application.

### Integrated Motion on an EtherNet/IP Network Example Configuration

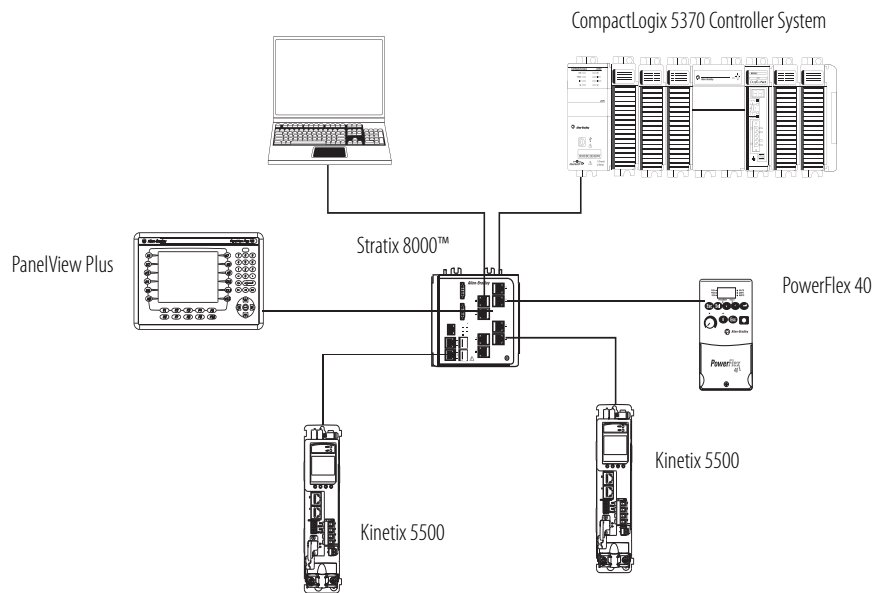

## SERCOS Interface Modules

Important: SERCOS interface modules are compatible with only version 20 or earlier of the RSLogix 5000 software.

The 1768 CompactLogix controller supports a SERCOS interface.

Cat. No.	Description	Number of Axis
1768-M04SE	1768 CompactLogix SERCOS interface modules	4

The SERCOS interface module can connect to these servo drives:

- 2093 Kinetix 2000 servo drive
- 2094 Kinetix 6000 servo drive
- 2094 Kinetix 6000M integrated drive-motor system
- 2099 Kinetix 7000 high-power servo drive
- 2098 Ultra™ 3000 SERCOS servo drive
- 1394C SERCOS drive
- 8720MC spindle

For detailed SERCOS specifications, see CompactLogix Integrated Motion Specifications Technical Data, publication [1768-TD001](#).

With this controller	You can have
1768-L43	<ul style="list-style-type: none"> <li>• Four axis</li> <li>• Two feedback axis</li> <li>• Six virtual axis</li> <li>• execution of 4 axes per 1 ms.</li> <li>• velocity bandwidth &gt; 400 Hz and current loop bandwidth &gt; 1000 Hz.</li> <li>• high resolution, unlimited travel, and absolute feedback features.</li> <li>• two feedback ports per Kinetix drive</li> </ul>
1768-L45	<ul style="list-style-type: none"> <li>• Eight axis</li> <li>• Four feedback axis</li> <li>• Six virtual axis</li> <li>• execution of 4 axes per 1 ms.</li> <li>• velocity bandwidth &gt; 400 Hz and current loop bandwidth &gt; 1000 Hz.</li> <li>• high resolution, unlimited travel, and absolute feedback features.</li> <li>• two feedback ports per Kinetix drive.</li> <li>• optional 2094 Line Interface Module (LIM) as the incoming power source for an entire control panel</li> </ul>

**1768 CompactLogix Controller and Three-axis Integrated Motion with Kinetix Servo Drives**

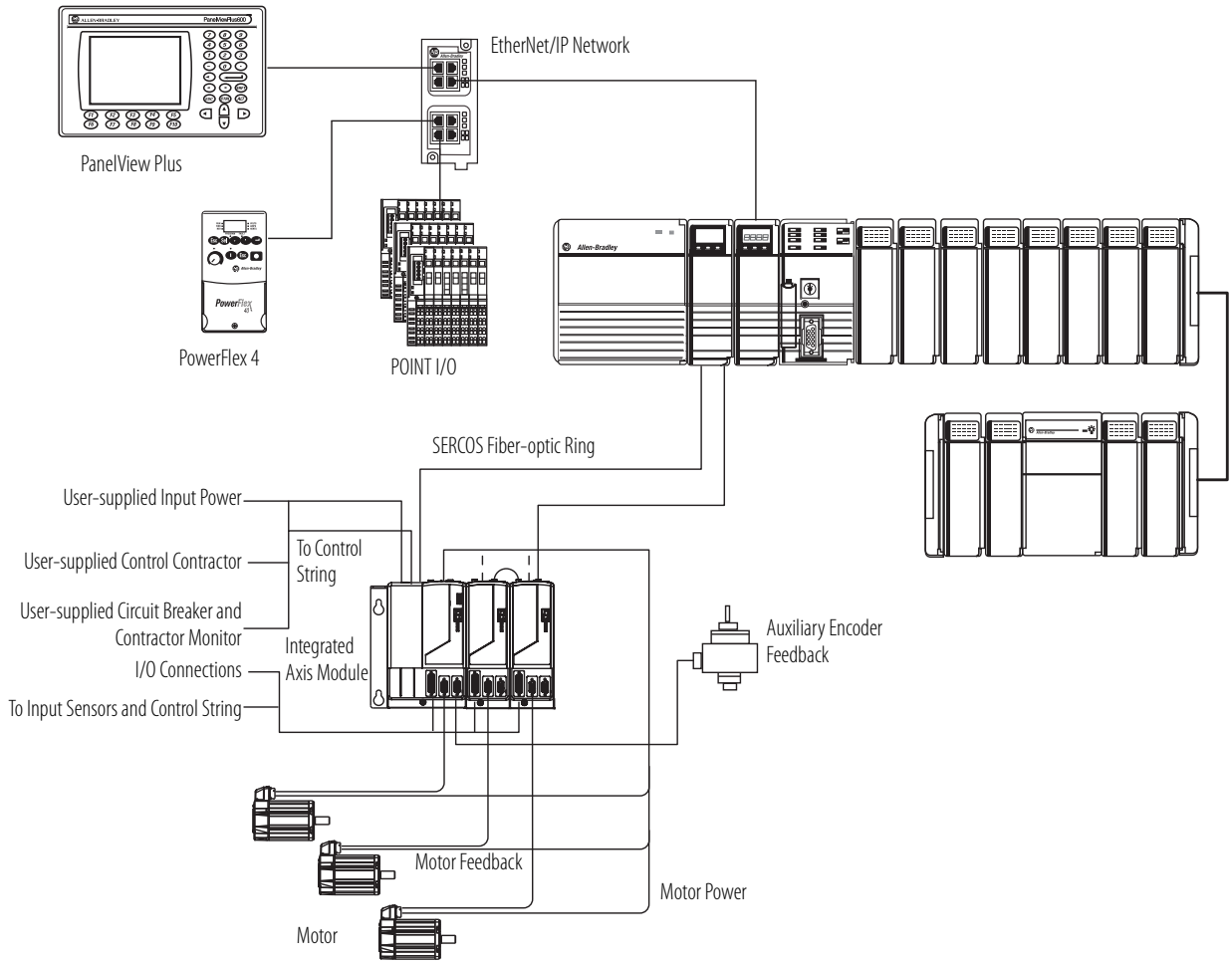

### 1768 CompactLogix Controller and Four-axis Integrated Motion with Kinetix Drives and LIM Interface

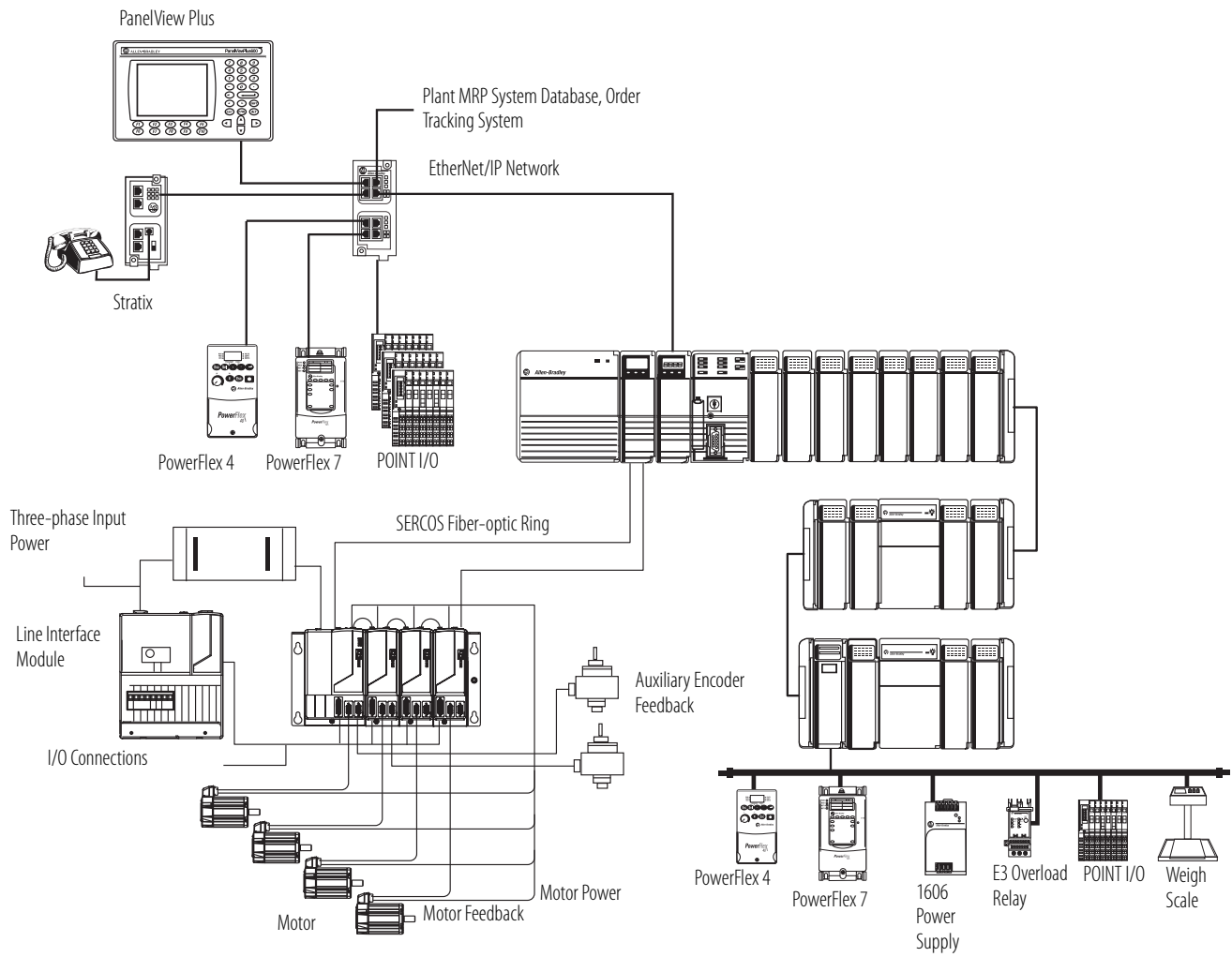

# Compact GuardLogix Integrated Safety

The Compact GuardLogix controller is a 1768-L4xS CompactLogix controller that provides safety control to achieve SIL 3/PLe according to ISO 13849. A major benefit of this system is that it is still one project, safety and standard together.

Application	Description
SIL 1, 2, 3	<p>The Compact GuardLogix controller system is type-approved and certified for use in safety applications up to and including SIL 3 according to IEC 61508, and applications up to and including PLe/Cat.4 according to ISO 13849-1. For more information, see:</p> <ul style="list-style-type: none"> <li>• GuardLogix Controllers Systems Safety Reference Manual, publication <a href="#">1756-RM093</a>.</li> <li>• Compact GuardLogix Controllers User Manual, publication <a href="#">1768-UM002</a>.</li> <li>• GuardLogix Safety Application Instruction Set Reference Manual, publication <a href="#">1756-RM095</a>.</li> </ul>

During development, safety and standard have the same rules, multiple programmers, online editing, and forcing are all possible. Once the project is tested and ready for final validation, you apply the safety application signature and safety-lock the application to set the safety task to a SIL 3 integrity level, which is enforced by the GuardLogix® controller. When safety memory is locked and protected, the safety logic can't be modified and all safety functions operate with SIL 3 integrity. On the standard side of the GuardLogix controller, all functions operate like a regular Logix controller. Thus online editing, forcing, and other activities are all possible.

With this level of integration, safety memory can be read by standard logic and external devices, like HMIs or other controllers, eliminating the need to condition safety memory for use elsewhere. The result is easy system-wide integration and the ability to display safety status on displays or marquees. Use Guard I/O modules for field device connectivity. For safety interlocking between GuardLogix controllers use Ethernet or ControlNet networks. Multiple GuardLogix controllers can share safety data for zone to zone interlocking, or one GuardLogix controller can use remote distributed safety I/O between cells/areas.

The Compact GuardLogix controller has these safety-related features and the standard features of a CompactLogix controller.

Characteristic	1768-L43S	1768-L45S
Available user memory	2 MB standard 0.5 MB safety	3 MB standard 1 MB safety
Communication options	<ul style="list-style-type: none"> <li>• EtherNet/IP (standard and safety)</li> <li>• ControlNet (standard and safety)</li> <li>• DeviceNet (standard)</li> </ul>	<ul style="list-style-type: none"> <li>• EtherNet/IP (standard and safety)</li> <li>• ControlNet (standard and safety)</li> <li>• DeviceNet (standard)</li> </ul>
Programming languages	<ul style="list-style-type: none"> <li>• Standard task: all languages</li> <li>• Safety task: relay ladder, safety application instructions</li> </ul>	<ul style="list-style-type: none"> <li>• Standard task: all languages</li> <li>• Safety task: relay ladder, safety application instructions</li> </ul>

# Additional Local I/O Modules

## 1734 POINT I/O Modules

Additional 1734 POINT I/O modules can be installed on a CompactLogix 5370 L1 controller. The POINT I/O family is ideal for applications where flexibility and low-cost of ownership are key for successful control system design and operation.

The base (A) mounts onto the DIN rail and provides the backplane. The POINT I/O module (B) snaps into the base. The removable terminal block (C) also snaps into the base and provides the wiring and terminations for field-side connections, and system power for the backplane.

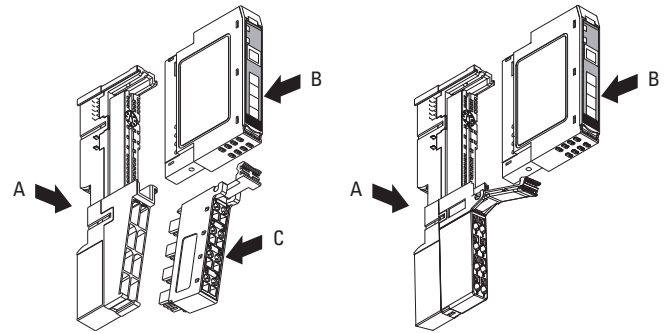

## 1734 AC Digital Modules

Cat. No.	Inputs/Outputs	Voltage Category	Wiring Base	POINTBus™ Current @ 5V DC
1734-IA2	2 inputs, nonisolated, sink	120V AC	1734-TB, 1734-TBS, 1734-TOP, 1734-TOPS	75 mA
1734-IA4	4 inputs, nonisolated, sink			
1734-IM2	2 inputs, nonisolated, sink	220V AC	1734-TB, 1734-TBS, 1734-TOP, 1734-TOPS	75 mA
1734-IM4	4 inputs, nonisolated, sink			
1734-OA2	2 outputs, nonisolated, source	120/220V AC	1734-TB, 1734-TBS, 1734-TOP, 1734-TOPS	75 mA
1734-OA4	4 outputs, nonisolated, source			

## 1734 DC Digital Modules

Cat. No.	Inputs/Outputs	Voltage Category	Wiring Base	POINTBus Current @ 5V DC
1743-IB2	2 inputs, sink	24V DC	1734-TB, 1734-TBS	75 mA
1734-IB4	4 inputs, sink			
1734-IB4D	4 inputs, sink, diagnostic	24V DC	1734-TB, 1734-TBS, 1734-TOP, 1734-TOPS	50 mA
1734-IB8	8 inputs, sink	24V DC	1734-TB, 1734-TBS	75 mA
1734-IB8S	8 inputs, sink, safety	24V DC	1734-TB, 1734-TOP	175 mA
1734-IV2	2 inputs, source	24V DC	1734-TB, 1734-TBS	75 mA
1734-IV4	4 inputs, source			
1734-IV8	8 inputs, source			

Cat. No.	Inputs/Outputs	Voltage Category	Wiring Base	POINTBus Current @ 5V DC
1734-OB2	2 outputs, nonisolated, source	12/24V DC	1734-TB, 1734-TBS	75 mA
1734-OB2E	2 outputs, nonisolated protected, source			
1734-OB4	4 outputs, nonisolated, source			
1734-OB4E	4 outputs, nonisolated protected, source			
1734-OB8	8 outputs, nonisolated, source			
1734-OB8E	8 outputs, nonisolated protected, source			
1734-OB8S	8 outputs, safety	24V DC	1734-TB, 1734-TOP	190 mA
1734-OV2E	2 outputs, nonisolated protected, sink	12/24V DC	1734-TB, 1734-TBS	75 mA
1734-OV4E	4 outputs, nonisolated protected, sink			
1734-OV8E	8 outputs, nonisolated protected, sink			

### 1734 Relay Contact Output Modules

Cat. No.	Inputs/Outputs	Voltage Range	Wiring Base	POINTBus Current @ 5V DC
1734-OW2	2 Form A (normally open) relays	5...28.8V DC @ 2.0 A 48V DC @ 0.5 A 125V DC @ 0.25 A 125V DC @ 2.0 A 240V AC @ 2.0 A	1734-TB, 1734-TBS	80 mA
1734-OW4	4 Form A (normally open) relays			
1734-OX2	2 Form C isolated (normally open; normally closed) electromechanical relays			100 mA

### 1734 Analog and Temperature Modules

Cat. No.	Inputs/Outputs	Range	Resolution	Wiring Base	POINTBus Current @ 5V DC
1734-IE2C	2 single-ended, nonisolated, current	4...20 mA 0...20 mA	16 bits over 0...21 mA 0.32 $\mu$ A/cnt	1734-TB, 1734-TBS	75 mA
1734-IE2V	2 single-ended, nonisolated, voltage	0...10V (-0.0V under, +0.5V over) $\pm$ 10V (-0.5V under, +0.5V over)	15 bits plus sign 320 $\mu$ V/cnt in unipolar or bipolar mode		
1734-IE4C	4 single-ended, nonisolated, current	4...20 mA 0...20 mA	16 bits - over 0...21 mA 0.32 $\mu$ A/cnt		
1734-IE4S	4 inputs, single-ended, safety rated	0...20 mA, 4...20 mA $\pm$ 5V, 0...5V, $\pm$ 10V, 0...10V	12 bits	1734-TB, 1734-TBS, 1734-TOP, 1734-TOPS, 1734-TOP3, 1734-TOP3S	110 mA
1734-IE8C	8 single-ended, nonisolated, current	4...20 mA 0...20 mA	16 bits - over 0...21 mA 0.32 $\mu$ A/cnt	1734-TB, 1734-TBS	75 mA
1734-IR2	2 single-ended, nonisolated	0...600 $\Omega$	16 bits 9.5 m $\Omega$ /cnt 0.03 $^{\circ}$ C/cnt (Pt385 @ 25 $^{\circ}$ C) [0.05 $^{\circ}$ F/cnt (Pt385 @ 77 $^{\circ}$ F)]	1734-TB, 1734-TBS, 1734-TOP, 1734-TOPS	220 mA
1734-IR2E	2 single-ended, nonisolated, protected	0...220 $\Omega$	16 bits 2.4 m $\Omega$ /cnt 0.006 $^{\circ}$ C/cnt (Pt385 @ 25 $^{\circ}$ C) [0.0114 $^{\circ}$ F/cnt (Pt385 @ 77 $^{\circ}$ F)]		

## Select a CompactLogix System

Cat. No.	Inputs/Outputs	Range	Resolution	Wiring Base	POINTBus Current @ 5V DC
1734-IT2I	2 differential, individually isolated	Sensors B, C, E, J, K, N, R, S, T	15 bits plus sign 2.5 $\mu$ V/cnt	1734-TBCJC	175 mA
1734-OE2C	2 single-ended, nonisolated, current	4...20 mA 0...20 mA	13 bits over 0...21mA 2.5 $\mu$ A/cnt (average) 3...2.7 $\mu$ A/cnt (typical range)	1734-TB, 1734-TBS, 1734-TB3, 1734-TB3S	75 mA
1734-OE2V	2 single-ended, nonisolated, voltage	0...10V (-0.0V under, +0.5V over) $\pm$ 10V (-0.5V under, +0.5V over)	14 bits (13 plus sign) 1.28 mV/cnt in unipolar or bipolar mode		
1734-OE4C	4 single-ended, nonisolated, current	4...20 mA 0...20 mA	16 bits over 0...21 mA 0.32 $\mu$ A/cnt)		

## 1734 Counter Modules

Cat. No.	Inputs/Outputs	Range	Frequency	Wiring Base	POINTBus Current @ 5V DC
1734-IJ	1 - 1 group of A/Areturn, B/Breturn and Z/Zreturn	5V DC	1.0 MHz counter and encoder X1 500 kHz encoder X2 (no filter) 250 kHz encoder X4 (no filter)	1734-TB, 1734-TBS, 1734-TB3, 1734-TB3S	160 mA
1734-IK	1 - 1 group of A/Areturn, B/Breturn and Z/Zreturn	15...24V DC			160 mA
1734-VHSC24	1 - 1 group of A/Areturn, B/Breturn and Z/Zreturn	15...24V DC			180 mA
1734-VHSC5	1 - 1 group of A/Areturn, B/Breturn and Z/Zreturn	5V DC			180 mA

## 1734 Self-configurable Modules

Cat. No.	Inputs/Outputs	Voltage Category	Wiring Base	POINTBus Current @ 5V DC
1734-8CFG	8 self configurable	24V DC	1734-TB, 1734-TBS, 1734-TOP, 1734-TOPS	100 mA

## 1734 Communication and Specialty Modules

Cat. No.	Description	Wiring Base	POINTBus Current
1734-AENT	The single port adapter connects POINT I/O modules to the Ethernet network.	N/A	N/A
1734-AENTR	The adapter connects POINT I/O modules to a linear or DLR network and uses two copper network ports to connect to the network.	N/A	N/A
1734-232ASC 1734-485ASC	The 1734-232ASC and 1734-485ASC serial interface modules offer a serial-link communication interface solution for peripheral products with RS-232 (only 1734-232ASC), RS-485, and RS-422 ports (only 1734-485ASC.)	1734-TB, 1734-TBS	75 mA
1734-ARM	The 1734-ARM address reserve module reserves address and slot numbers to maintain a numbering scheme of a system. The 1734-ARM has no module configuration and does not communicate I/O data.	1734-TB, 1734-TBS	75 mA
1734-CTM 1734-VTM	The common terminal module (1734-CTM) and voltage terminal module (1734-VTM) expand the termination capabilities of POINT I/O modules. Install the modules to provide support for higher density (8 channel) POINT I/O modules.	1734-TB, 1734-TBS, 1734-TOP, 1734-TOPS	75 mA
1734-SSI	The 1734-SSI module collects serial data from absolute-position, encoding sensors that use standard Synchronous Serial Interface (SSI) protocol.	1734-TB, 1734-TBS	110 mA



## 1769 Compact I/O Modules

The 1769 Compact I/O modules can be used with the CompactLogix 5370 L2 and L3 controllers and 1768 CompactLogix controllers as follows:

- Local I/O modules
- Remote I/O modules accessible by using a 1769-AENTR EtherNet/IP adapter

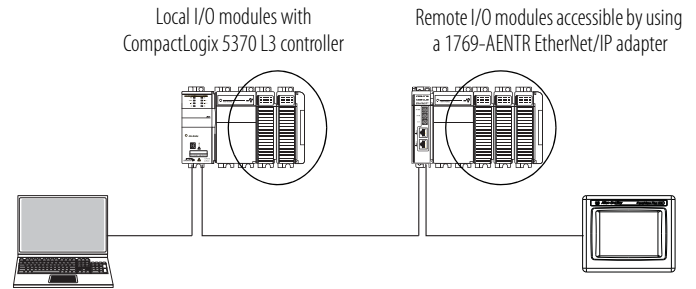

The modules mechanically lock together by means of a tongue-and-groove design and have an integrated communication bus that is connected from module to module by a moveable bus connector.

Each I/O module includes a built-in removable terminal block with finger-safe cover for connections to I/O sensors and actuators. The terminal block is behind a door at the front of the module. I/O wiring can be routed from beneath the module to the I/O terminals.

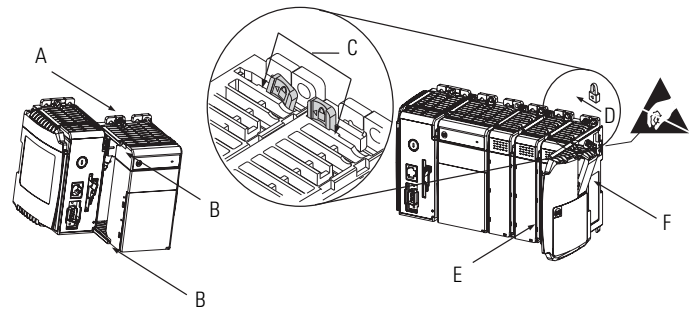

For detailed specifications, see 1769 Compact I/O Modules Specifications Technical Data, publication [1769-TD006](#).

### Power Supply Distance Ratings

Check each module's specification table for the power supply distance rating. This indicates how many slot positions the module can be from the power supply.

### 1769 AC Digital Modules

Cat. No.	Inputs/Outputs	Voltage Category	Operating Voltage Range	Backplane Current	Power Supply Distance Rating
1769-IA8I	8 inputs, individually isolated	100/120V AC	79...132V AC, 47...63 Hz	90 mA @ 5.1V <sup>(1)</sup>	8
1769-IA16	16 inputs	100/120V AC	79...132V AC, 47...63 Hz	115 mA @ 5.1V	8
1769-IM12	12 inputs	200/240V AC	159...265V AC, 47...63 Hz	100 mA @ 5.1V	8
1769-OA8	8 outputs	100/240V AC	85...265V AC 47...63 Hz	145 mA @ 5.1V	8
1769-OA16	16 outputs	100/240V AC	85...265V AC 47...63 Hz	225 mA @ 5.1V	8

(1) Maximum is 190 mA.

## 1769 DC Digital Modules

Cat. No.	Inputs/Outputs	Voltage Category	Operating Voltage Range	Backplane Current	Power Supply Distance Rating
1769-IG16	16 inputs	5V DC TTL	4.5...5.5V DC	120 mA @ 5.1V	8
1769-IQ16	16 inputs	24V DC sink/source	10...30V DC @ 30 °C (86 °F) 10...26.4V DC @ 60 °C (140 °F)	115 mA @ 5.1V	8
1769-IQ16F	16 inputs, high-speed	24V DC sink/source	10...30V DC @ 30 °C (86 °F) 10...26.4V DC @ 60 °C (140 °F)	100 mA @ 5.1V	8
1769-IQ32	32 inputs	24V DC sink/source	10...30V DC @ 30 °C (86 °F) 10...26.4V DC @ 60 °C (140 °F)	170 mA @ 5.1V	8
1769-IQ32T	32 inputs	24V DC sink/source	20.4...26.4V DC @ 60 °C (140 °F)	170 mA @ 5.1V	8
1769-IQ6XOW4	6 inputs 4 outputs	24V DC sink/source input AC/DC normally open relay contact outputs	10...30V DC @ 30 °C (86 °F) 10...26.4V DC @ 60 °C (140 °F)	105 mA @ 5.1V 50 mA @ 24V	8
1769-OB8	8 outputs	24V DC source	20.4...26.4V DC	145 mA @ 5.1V	8
1769-OB16	16 outputs	24V DC source	20.4...26.4V DC	200 mA @ 5.1V	8
1769-OB16P	16 outputs, protected	24V DC source	20.4...26.4V DC	160 mA @ 5.1V	8
1769-OB32	32 outputs	24V DC source	20.4...26.4V DC	300 mA @ 5.1V	6
1769-OB32T	32 outputs	24V DC source	10.2...26.4V DC	220 mA @ 5.1V	8
1769-OG16	16 outputs	5V DC TTL	4.5...5.5V DC	200 mA @ 5.1V	8
1769-OV16	16 outputs	24V DC sink	20.4...26.4V DC	200 mA @ 5.1V	8
1769-OV32T	32 outputs	24V DC sink	10.2...26.4V DC	300 mA @ 5.1V	8

## 1769 Contact Output Modules

Cat. No.	Inputs/Outputs	Operating Voltage Range	Backplane Current	Power Supply Distance Rating
1769-OW8	8 outputs	5...265V AC 5...125V DC	125 mA @ 5.1V 100 mA @ 24V	8
1769-OW8I	8 outputs, individually isolated	5...265V AC 5...125V DC	125 mA @ 5.1V 100 mA @ 24V	8
1769-OW16	16 outputs	5...265V AC 5...125V DC	205 mA @ 5.1V 180 mA @ 24V	8

## 1769 Analog Modules

Cat. No.	Inputs/Outputs	Range	Resolution	Backplane Current	Power Supply Distance Rating
1769-IF4	4 inputs, differential or single-ended	±10V 0...10V 0...5V 1...5V 0...20 mA 4...20 mA	14 bits (unipolar) 14 bits plus sign (bipolar)	120 mA @ 5.1V 60 mA @ 24V	8
1769-IF4I	4 inputs, differential or single-ended, individually isolated	±10V 0...10V 0...5V 1...5V 0...20 mA 4...20 mA	16 bits (unipolar) 15 bits plus sign (bipolar)	145 mA @ 5.1V 125 mA @ 24V	8
1769-IF8	8 inputs, differential or single-ended	±10V 0...10V 0...5V 1...5V 0...20 mA 4...20 mA	16 bits (unipolar) 15 bits plus sign (bipolar)	120 mA @ 5.1V 70 mA @ 24V	8
1769-IF16C	16 inputs, single-ended	0...20 mA 4...20 mA	16 bits (unipolar) 15 bits plus sign (bipolar)	190 mA @ 5.1V 70 mA @ 24V	8
1769-IF16V	16 inputs, single-ended	±10V 0...10V 0...5V 1...5V	16 bits (unipolar) 15 bits plus sign (bipolar)	190 mA @ 5.1V 70 mA @ 24V	8
1769-IF4XOF2	4 differential or single-ended inputs 2 single-ended outputs	0...10V 0...20 mA	Input: 8 bits plus sign Output: 8 bits plus sign	120 mA @ 5.1V 160 mA @ 24V	8
1769-IF4FXOF2F	4 fast differential or single-ended inputs 2 fast single-ended outputs	±10V 0...10V 0...5V 1...5V 0...20 mA 4...20 mA	Input: 14 bits (unipolar) 14 bits plus sign (bipolar) Output: 13 bits (unipolar) 13 bits plus sign (bipolar)	220 mA @ 5.1V 120 mA @ 24V	8
1769-OF2	2 outputs, single-ended	±10V 0...10V 0...5V 1...5V 0...20 mA 4...20 mA	14 bits (unipolar) 14 bits plus sign (bipolar)	120 mA @ 5.1V 120 mA @ 24V	8
1769-OF4	4 outputs, single-ended	±10V 0...10V 0...5V 1...5V 0...20 mA 4...20 mA	15 bits plus sign unipolar and bipolar	120 mA @ 5.1V 170 mA @ 24V	8
1769-OF4CI	4 outputs, differential, individually isolated	0...20 mA 4...20 mA	16 bits (unipolar)	165 mA @ 5V 110 mA @ 24V	8

## Select a CompactLogix System

Cat. No.	Inputs/Outputs	Range	Resolution	Backplane Current	Power Supply Distance Rating
1769-OF4VI	4 outputs, differential, individually isolated	±10V 0...10V 0...5V 1...5V	15 bits plus sign (bipolar)	145 mA @ 5.1V 75 mA @ 24V	8
1769-OF8C	8 outputs, single-ended	0...20 mA 4...20 mA	16 bits (unipolar)	140 mA @ 5.1V 145 mA @ 24V	8
1769-OF8V	8 outputs, single-ended	±10V 0...10V 0...5V 1...5V	16 bits plus sign (bipolar)	145 mA @ 5.1V 125 mA @ 24V	8

## 1769 Analog RTD and Thermocouple Modules

Cat. No.	Inputs/Outputs	Sensors Supported	Backplane Current	Power Supply Distance Rating
1769-IR6	6 RTD inputs	100, 200, 500, 1000 Ω Platinum 385 100, 200, 500, 1000 Ω Platinum 3916 120 Ω Nickel 618 120 Ω Nickel 672 10 Ω Nickel-iron 518 0...150 Ω 0...500 Ω 0...1000 Ω 0...3000 Ω	100 mA @ 5.1V 45 mA @ 24V	8
1769-IT6	6 thermocouple inputs	Thermocouple types B, C, E, J, K, N, R, S, T ±50V ±100V	100 mA @ 5.1V 45 mA @ 24V	8 <sup>(1)</sup>

(1) To reduce the effects of electrical noise, install the 1769-IT6 module at least two slots away from the AC power supplies.

## 1769 Communication and Specialty Modules

Cat. No.	Description	Backplane Current	Power Supply Distance Rating
1769-AENTR	The adapter connects 1769 I/O modules to a linear or DLR network and uses two copper network ports to connect to the network.	500 mA @ 5V	5
1769-ARM	Use a 1769-ARM address reserve module to reserve module slots. After creating an I/O configuration and user program, you can remove and replace any I/O module in the system with a 1769-ARM module once you inhibit the removed module in the Logix Designer application.	60 mA @ 5.1V	8
1769-ASCII	The 1769-ASCII module, a general purpose two-channel ASCII interface, provides a flexible network interface to a wide variety of RS-232, RS-485, and RS-422 ASCII devices. The module provides the communication connections to the ASCII device.	425 mA @ 5.1V	4
1769-BOOLEAN	Use the 1769-BOOLEAN module in applications that require repeatability, such as material handling and packaging, when there is a requirement to activate an output based on an input's transition. If the Boolean expression is true, the output is directed to the ON state. If the Boolean expression is false, the output channel is directed to the OFF state. There are four operators that you can configure as OR, AND, XOR, or none.	220 mA @ 5.1V	8

Cat. No.	Description	Backplane Current	Power Supply Distance Rating
1769-HSC	Use the 1769-HSC when you need: <ul style="list-style-type: none"> <li>• a counter module that is capable of reacting to high-speed input signals.</li> <li>• to generate rate and time-between-pulses (pulse interval) data.</li> <li>• as many as two channels of quadrature or four channels of pulse/count inputs.</li> </ul>	245 mA @ 5.1V	4
1769-SM1	The Compact I/O to DPI/SCANport™ module connects to PowerFlex 7-class drives, other DPI-based host devices, and SCANport-based host devices such as 1305 and 1336 PLUS II drives.	280 mA @ 5.1V	6
1769-SM2	The Compact I/O to DSI/Modbus module connects to PowerFlex 4-class drives and to other Modbus RTU slave devices, such as PowerFlex 7-class drives with 20-COMM-H RS485 HVAC adapters.	350 mA @ 5.1V	4

## 1769 Expansion Cables

If you divide 1769 modules into multiple banks, make sure:

- each bank needs its own power supply.
- use expansion cables to connect the banks.
- the last I/O bank requires an end cap.

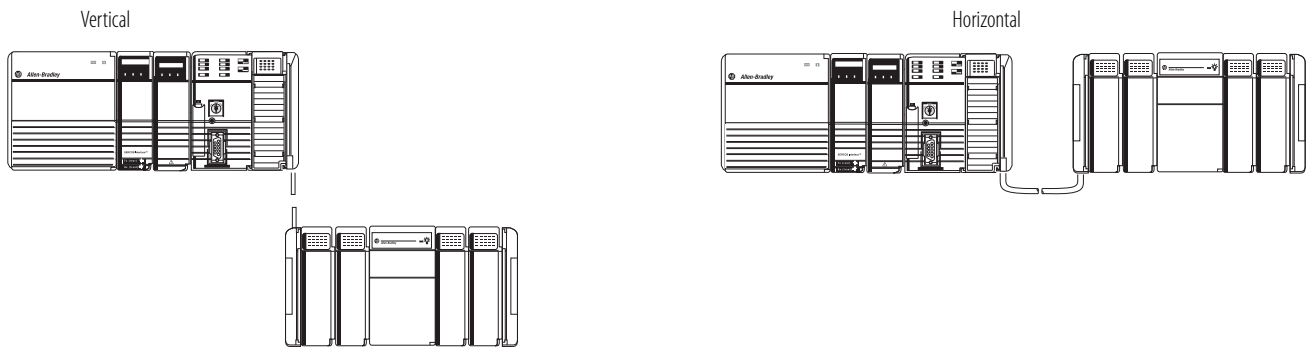

How you orient I/O banks determines the expansion cables you must connect the I/O banks.

If you add a	And connect the chassis	Use this cable <sup>(1)</sup>
Second bank	Right to left	1769-CRLx
	Right to right	1769-CRRx
Third bank	Right to left	1769-CRLx
	Right to right	1769-CRRx
	Left to left	1769-CLLx

(1) Where x = 1 for 1 ft (305 mm) or 3 for 3.28 ft (1 m).

## 1769 End Caps

The final 1769 Compact I/O bank requires an end cap on the end without the expansion cable. The CompactLogix 5370 L2 controller comes with a right-end cap, so you do not need to order one separately.

- Right end cap, catalog number 1769-ECR
- Left end cap, catalog number 1769-ECL

## 1769 Wiring Systems

As an alternative to buying removable terminal blocks (RTBs) and connecting the wires yourself, you can buy a wiring system of:

- interface modules (IFMs) that provide the output terminal blocks for digital I/O modules. Use the pre-wired cables that match the I/O module to the IFM.
- analog interface modules (AIFMs) that provide the output terminal blocks for analog I/O modules. Use the pre-wired cables that match the I/O module to the AIFM.
- I/O module-ready cables. One end of the cable assembly is an RTB that plugs into the front of the I/O module. The other end has individually color-coded conductors that connect to a standard terminal block.

## Removable Terminal Kits

You can order removable terminal kits with the CompactLogix 5370 L1 and L2 controllers separately. The kits are used to connect wiring to the controllers. describes the kits.

Cat. Nos.	Controllers Supported	Description
1769-RTB45	CompactLogix 5370 L1	<ul style="list-style-type: none"> <li>• Four 10-pin connectors used to connect wiring to the controllers' embedded digital I/O module.</li> <li>• One 5-pin connector used to connect an external 24V DC power source to the controller.</li> </ul>
1769-RTB40DIO	CompactLogix 5370 L2	Four 10-pin connectors used to connect wiring to the controllers' embedded digital I/O module.
1769-RTB40AIO	1769-L24ER-QBFC1B and 1769-L27ERM-QBFC1B	Four 10-pin connectors used to connect wiring to the controllers' embedded analog I/O module.

# CompactLogix Power Supplies

Select power supplies based on the controller and the number of additional I/O banks.

For a	Select
CompactLogix 5370 L3 controller	<ul style="list-style-type: none"> <li>One 1769 power supply for the controller and local I/O modules</li> <li>One 1769 power supply for each additional bank of I/O modules</li> </ul>
CompactLogix 5370 L2 controller	No power supply as it is integral to the controller package
CompactLogix 5370 L1 controller	No power supply as it is integral to the controller package
1768 CompactLogix controller	<ul style="list-style-type: none"> <li>One 1768 power supply for the controller and 1768 modules</li> <li>One 1769 power supply for each additional bank of I/O modules</li> </ul>

## Power Supplies

Cat. No.	Description	Voltage Category	Operating Voltage Range
1769-PA2	1769 Compact I/O expansion power supply	120V/220V AC	85...265V AC
1769-PB2		24V DC	19.2...31.2V DC
1769-PA4		120V/220V AC	85...265V AC or 170...265V AC (switch selectable) 47...63 Hz
1769-PB4		24V DC	19.2...31.2V DC
1768-PA3	1768 CompactLogix power supply	120V/220V AC	85...265V AC or 108...132V DC
1768-PB3		24V DC	16.8...31.2V DC

For detailed specifications, see Compact Power Supplies Specifications Technical Data, publication [1769-TD008](#).

# Programming Software

Your selection of modules and network configuration determines what software packages you need to configure and program your system.

## Studio 5000 Environment

The Studio 5000 Automation Engineering & Design Environment™ combines engineering and design elements into a common environment. The first element in the Studio 5000® environment is the Studio 5000 Logix Designer™ application. The Logix Designer application is the rebranding of RSLogix™ 5000 software and continues to be the product to program Logix5000™ controllers for discrete, process, batch, motion, safety, and drive-based solutions.



The Studio 5000 environment is the foundation for the future of Rockwell Automation® engineering design tools and capabilities. This environment is the one place for design engineers to develop all elements of their control system.

The Studio 5000 environment does not support the following controllers.

- 1768 CompactLogix controllers
- 1769-L23x Packaged CompactLogix controllers
- 1769-L3x Modular CompactLogix controllers

You must use RSLogix 5000 software, version 20 or earlier, with the previously listed controllers.



## CompactLogix System Software

If you have	You need	Order
CompactLogix controller 1768-M04SE SERCOS motion module	Studio 5000 Logix Designer™ application	9324 series <sup>(1)</sup>
1768-CNB, 1768-CNBR ControlNet communication module	RSNetWorx™ for ControlNet software	9324 series <sup>(2)</sup> or 9357-CNETL3 (RSNetWorx for ControlNet)
1769-SDN DeviceNet communication module	RSNetWorx for DeviceNet software	9324 series <sup>(2)</sup> or 9357-DNETL3 (RSNetWorx for DeviceNet)
1768-ENBT, 1768-EWEB EtherNet/IP communication module EtherNet/IP ports (CompactLogix 5370 controllers)	RSLin® software or BOOTP/DHCP server utility to set IP addresses Optional RSNetWorx for EtherNet/IP software	9324 series <sup>(2)</sup> or Optional 9357-ENETL3 (RSNetWorx for EtherNet/IP)
Communication card in a workstation	RSLin software	9324 series <sup>(1)</sup>

(1) All 9324 packages include RSLinx Classic Light software.

(2) Comes with some editions of Studio 5000 environment.

Notes:



Allen-Bradley, Compact GuardLogix, Compact I/O, CompactBlock Guard I/O, CompactLogix, ControlLogix, FactoryTalk, GuardLogix, Integrated Architecture, Kinetix, Logix5000, PanelView, POINT Guard I/O, POINT I/O, POINTBus, PowerFlex, Rockwell Software, Rockwell Automation, RSLinx, RSLogix, RSNetWorx, SCANport, SoftLogix, Stratix 6000, Stratix 8000, Studio 5000, Studio 5000 Automation Engineering & Design Environment, Studio 5000 Logix Designer, and Ultra are trademarks of Rockwell Automation, Inc.

Trademarks not belonging to Rockwell Automation are property of their respective companies.

**[www.rockwellautomation.com](http://www.rockwellautomation.com)**

---

**Power, Control and Information Solutions Headquarters**

Americas: Rockwell Automation, 1201 South Second Street, Milwaukee, WI 53204-2496 USA, Tel: (1) 414.382.2000, Fax: (1) 414.382.4444

Europe/Middle East/Africa: Rockwell Automation NV, Pegasus Park, De Kleetlaan 12a, 1831 Diegem, Belgium, Tel: (32) 2 663 0600, Fax: (32) 2 663 0640

Asia Pacific: Rockwell Automation, Level 14, Core F, Cyberport 3, 100 Cyberport Road, Hong Kong, Tel: (852) 2887 4788, Fax: (852) 2508 1846