

# Modicon 984 Hot Standby System Installation & Maintenance Manual

GM-S911-001 Rev. B

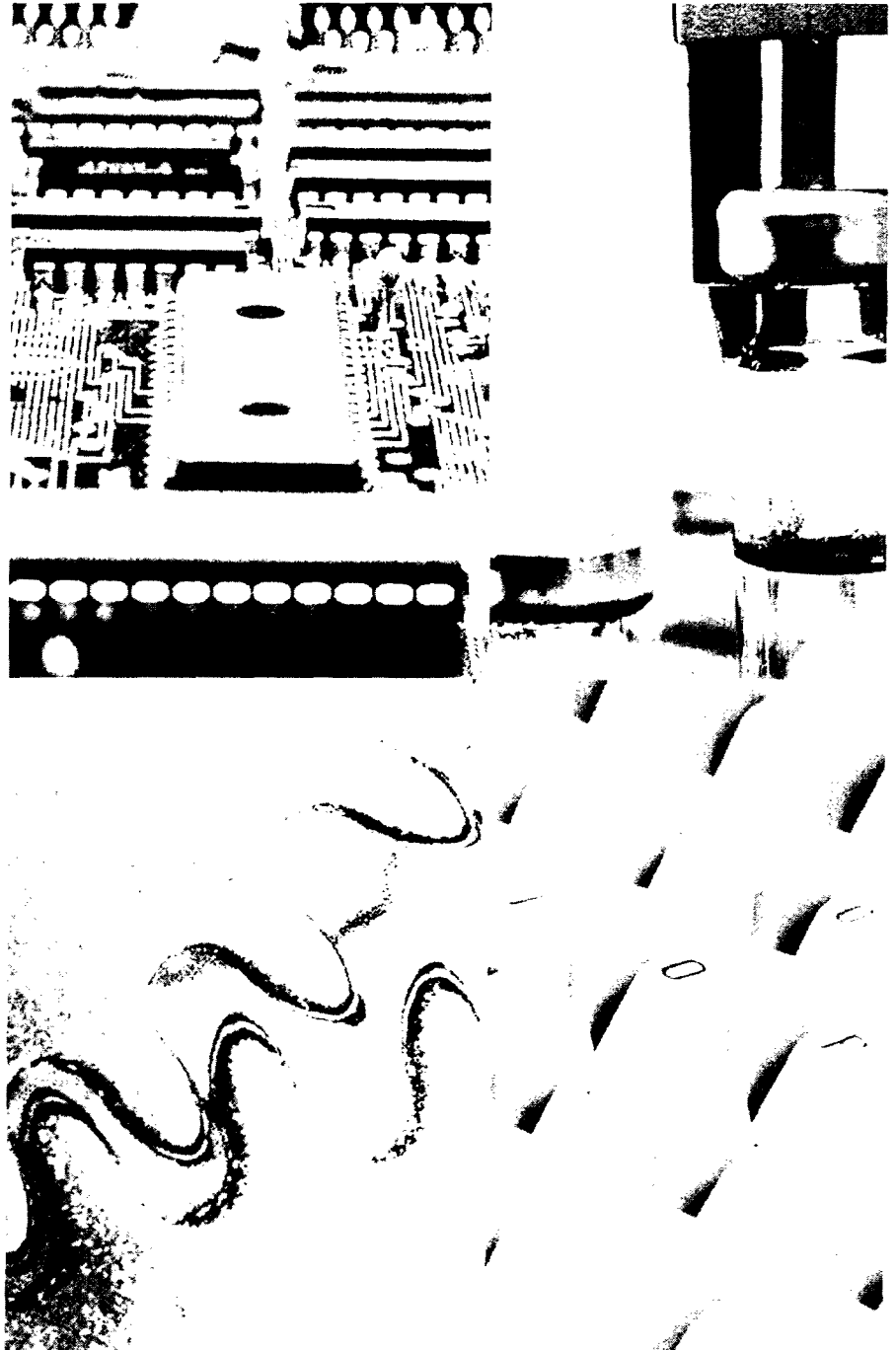

**GROUPE SCHNEIDER**

■ Merlin Gerin ■ Modicon ■ Square D ■ Telemecanique



**MODICON**  
**984 Hot Standby System**  
**Installation and Maintenance Manual**

---

September 1988

MODICON, Inc., Industrial Automation Systems  
One High Street  
North Andover, Massachusetts 01845



## **Preface**

---

The information in this document is subject to change without notice and should not be construed as a commitment by MODICON Inc., Industrial Automation Systems Group. MODICON, Inc. assumes no responsibility for any errors that may appear in this document. No part of this document may be reproduced in any form without the express written permission of MODICON, Inc., Industrial Automation Systems Group. All rights reserved.

The following are trademarks of MODICON, Inc.:

MODICON	184	584L
Micro 84	384	884
MODBUS	484	984
MODVUE	584	P180
MODWAY	584M	P190
Cell Controller		

IBM © is a registered trademark of International Business Machines, Inc.; IBM PC is a trademark of International Business Machines, Inc.

© Copyright 1988, MODICON, Inc.

Printed in U. S. A.

# ***How to Use 984 Hot Standby System Documentation***

---

There are two books in the 984 Hot Standby System documentation set – this book and the *984 Hot Standby System Programming Manual* (GM-S911-002).

## ***Scope***

The Hot Standby System provides fault-tolerant, high-availability programmable control (PC). Use the two books in this documentation set in the planning, installation, programming, and maintenance of the hot standby capability for a 984 PC system.

This book is written for planners, installers, and maintenance technicians familiar with PC concepts and the physical and environmental requirements of the 984 family of MODICON PC's.

## ***Related Documentation***

These books deal expressly with the 984 Hot Standby capability. For other aspects of 984 programmable control, refer to these documents:

- *984 PC System Planning and Installation Guide* (GM-0984-003)
- *984-680 PC System Planning and Installation Guide* (GM-0984-101)
- *984 Programmable Controller P190 Programming Guide* (GM-0984-001)
- *584 and 984 Controller Tape Loader User's Guide* (GM-T984-001)
- *984/PC Programming Guide* (GM-0984-IBM)
- *584/984 Controller and IBM PC Load/Record/Verify User's Guide* (GM-HIBM-002)
- *P964 Data Access Panel User's Guide* (GM-P964-001)
- *P810 Remote I/O Power Supply Installation Instructions* (PI-810-001)
- *J890/J892 Remote I/O Processor User's Guide* (GM-J890-001)

## ***Starting Up the Hot Standby System Safely***

- ▶ **CAUTION** Familiarize yourself with *all* hot standby documentation before you power up the system. Make sure that you understand all the cautions and warnings described in these books.

## ***How this Manual Is Organized***

Use this manual to plan, install, and maintain a hot standby capability for your MODICON 984 PC application. It contains five chapters:

- Chapter 1, Introduction, describes the theory of operations and the basic hardware components of the four types of 984 Hot Standby Systems.
- Chapter 2, Planning, explains how to plan the configuration and installation of your 984 Hot Standby System.
- Chapter 3, Installation, gives you the procedures for installing your 984 Hot Standby System.
- Chapter 4, Startup, describes startup procedures for a 984 Hot Standby System.
- Chapter 5, Maintenance, can help you troubleshoot problems you might encounter when starting up or running a 984 Hot Standby System.
- Electrical, environmental, and performance specifications for the S911 modules are given in the appendix.

## ***Receiving New Components***

---

When you receive your 984 Hot Standby System, verify that the shipment is complete and undamaged.

### ***Inspecting Incoming Hot Standby Components***

Unpack each system component carefully. If you find any damage or missing components, inform the freight carrier and your distributor immediately.

Save all shipping papers until the installation is complete. Save all cartons and packing material in case you later need to ship any component for repair.

### ***Sending A Component Back?***

If you need to return a faulty component, use the original packing materials supplied by MODICON, if possible. Components should be firmly packed so they do not move around in the shipping container. Components should be protected against impact during shipment.

### ***Customer Service and Technical Assistance***

To call us anywhere in North America except from within Massachusetts, dial 1-800-468-5342. Within Massachusetts or outside North America, dial 1-(508)-975-5001.

If you dial the 800 number, you will get a recording asking you to enter a one-digit code for the type of service you want:

<b>Code</b>	<b>Service</b>
1	Hardware/software technical support
2	Order entry, buying hardware and/or software
3	Return/exchange status inquiries
4	Training/course registration inquiries
5	Other general information

This works only with a *touch tone* phone. If you are using a dial phone, just wait a moment – the operator will take your call after a short pause.

If you call the 5001 number, you will get the operator immediately; ask for any of the services above.



# **Contents**

---

## **CHAPTER 1 INTRODUCTION**

What a Hot Standby System Does	1-2
Constant Control Through Redundancy	1-2
Primary and Standby Control	1-2
Hardware Components in a Hot Standby System	1-4
Four Types of Mainframes	1-4
984 Hot Standby Hardware	1-4
Increasing Power for Additional Option Modules	1-5
Communication Between Primary and Standby Modules	1-5
The S911 Hot Standby Module	1-6
Two Versions of the S911 Hot Standby Module	1-6
LED Displays	1-7
Keyswitches	1-7
Toggle Switches and W911 Cable Connections	1-7
984 Remote I/O Processors	1-8
Three Types of 984 Remote I/O Processors	1-8
LED Displays	1-9
Cable Connections	1-9
Dual and Redundant Cable Options	1-9
End User Part Numbers	1-10

## **CHAPTER 2 PLANNING**

Some General and Specific Planning Guidelines	2-2
Standard Planning Guidelines	2-2
Environment	2-2
Local I/O Restrictions	2-2
Planning a New Hot Standby System	2-3
Requirements	2-3
Recommendations	2-3
Planning a Retrofit Hot Standby System	2-4
Additional Planning Considerations	2-4
Increasing Power for Additional Option Modules	2-5
Optional Hardware Configurations	2-6
Dual and Redundant Cabling to Remote I/O Drops	2-6
Optional System Control	2-6

## **CHAPTER 3    INSTALLATION**

Chassis for the 984A or 984B Mainframes	3-2
984A Hardware Configuration	3-2
984B Hardware Configuration	3-3
Chasis for the 984X Mainframes	3-4
984X Hardware Configuration	3-4
Housings for the 984-680 Mainframes	3-5
Basic Hardware Configuration	3-5
The Redundancy Terminator Kit	3-6
In-line Terminator Components	3-6
Assembling the Redundancy Terminator Kit	3-6
984 Hot Standby Installation Procedures	3-8
984 Hot Standby System Diagrams	3-10
Redundant Remote I/O Cabling in an HSBY System	3-12
Dual Remote I/O Cabling in an HSBY System	3-14
Installing Redundant Remote Cables	3-16
Installing Dual Remote Cables	3-17

## **CHAPTER 4    STARTUP**

Startup Procedures	4-2
Automatic Operation	4-4
Mainframe Fault Response	4-4
Switchover Time	4-4
Changing EXEC's While the System Is Running	4-5
Some Illegal Startup Procedures	4-6
Starting the System Without Any Cables Connected	4-6
Starting a System With Only a W911 Cable Connected	4-6
Trying to Connect Cable to a Running System	4-6

## **CHAPTER 5    MAINTENANCE**

Automatic Confidence Tests	5-2
Startup Tests	5-2
Run Time Tests	5-2
Indicators of a Healthy Hot Standby System	5-3
Automatic Error Detection	5-4
Detecting Fatal Errors	5-4
LED Error Indicators	5-4
Checking Startup Error Codes	5-4
Board-level Error Indicators	5-5
Communication and Interface Error Indicators	5-6
Startup Error Indicators	5-7

Troubleshooting 5-8  
    Troubleshooting Precautions 5-8  
Restart After a Major Repair 5-10  
Testing Hot Standby Switchover 5-11

**APPENDIX    S911 MODULE SPECIFICATIONS**

**INDEX**

## **Figures**

1-1	How a Hot Standby System Works	1-3
1-2	S911 Hot Standby Modules	1-6
1-3	984 Remote I/O Processors	1-8
3-1	984A Hot Standby Hardware Configuration	3-2
3-2	984B Hot Standby Hardware Configuration	3-3
3-3	984X Hot Standby Hardware Configuration	3-4
3-4	984-680 Hot Standby Hardware Configuration	3-5
3-5	Redundancy Terminator Components	3-6
3-6	984A Hot Standby System Diagram	3-10
3-7	984B Hot Standby System Diagram	3-10
3-8	984X Hot Standby System Diagram	3-11
3-9	984-680 Hot Standby System Diagram	3-11
3-10	Redundant I/O Cables for a 984A Hot Standby System	3-12
3-11	Redundant I/O Cables for a 984B Hot Standby System	3-13
3-12	Redundant I/O Cables for a 984-680 Hot Standby System	3-13
3-13	Dual I/O Cables for a 984A Hot Standby System	3-14
3-14	Dual I/O Cables for a 984B Hot Standby System	3-15
3-15	Dual I/O Cables for a 984-680 Hot Standby System	3-15
5-1	Indicators of a Healthy Hot Standby System	5-3
5-2	PROM Cecksum Error	5-5
5-3	RAM Data Error	5-5
5-4	RAM Address Error	5-5
5-5	Parity Error	5-5
5-6	Communication Error	5-6
5-7	Interface Error	5-6
5-8	Startup Errors	5-7

## **Tables**

1-1	984 Minimum Hardware Configurations	1-6
1-2	984A Hot Standby End User Part Numbers	1-12
1-3	984B Hot Standby End User Part Numbers	1-12
1-4	984X Hot Standby End User Part Numbers	1-13
1-5	984-680 Hot Standby End User Part Numbers	1-13
2-1	Hot Standby Compatibility Specifications	2-4
4-1	Hot Standby Mainframe Normal Indications	4-3
5-1	Troubleshooting Hot Standby Fault Indications	5-9

# **Chapter 1**

## **Introduction**

---

- What a Hot Standby System Does
- Hardware Components in a Hot Standby System
- The S911 Hot Standby Module
- 984 Remote I/O Processors
- End User Part Numbers

## **What a Hot Standby System Does**

---

The hot standby approach is based on two identical 984 controllers communicating with each other via special hot standby hardware and software. If one controller fails, the other takes over I/O control in no more than 48 ms.

### **Constant Control Through Redundancy**

The 984 Hot Standby System has been designed for applications that demand fault-tolerant, high-availability performance. The system delivers reliability through redundancy. Two PC mainframes are configured such that one is ready to assume control if the other fails; both contain identical hardware and software.

A loadable hot standby (HSBY) function block is the key software element of the Hot Standby System. It must be loaded into both controllers before the system is started up.

### **Primary and Standby Control**

The *primary* controller runs your application by scanning ladder logic and operating remote I/O. The primary updates the *standby* controller with current status information after each scan. The standby is ready to assume control within one scan (no more than 48 ms) if the primary fails.

Primary and standby states are *switchable*; either controller can be put in the primary state, but the other must be in the standby state. The remote I/O is always controlled by the controller in the primary state.

- ▶ **NOTE** A 984 Hot Standby System controls only 800-series remote I/O; local I/O is not supported.

Each mainframe contains an *S911 hot standby module* that monitors its own mainframe and communicates with the S911 in the other mainframe.

As shown in figure 1-1, a Hot Standby System continuously monitors itself for fault conditions. If the primary controller fails, it switches control to the standby, which then becomes the primary controller. If the standby controller fails, the primary continues to operate as a standalone controller.

Figure 1-1

How a 984 Hot Standby System Works

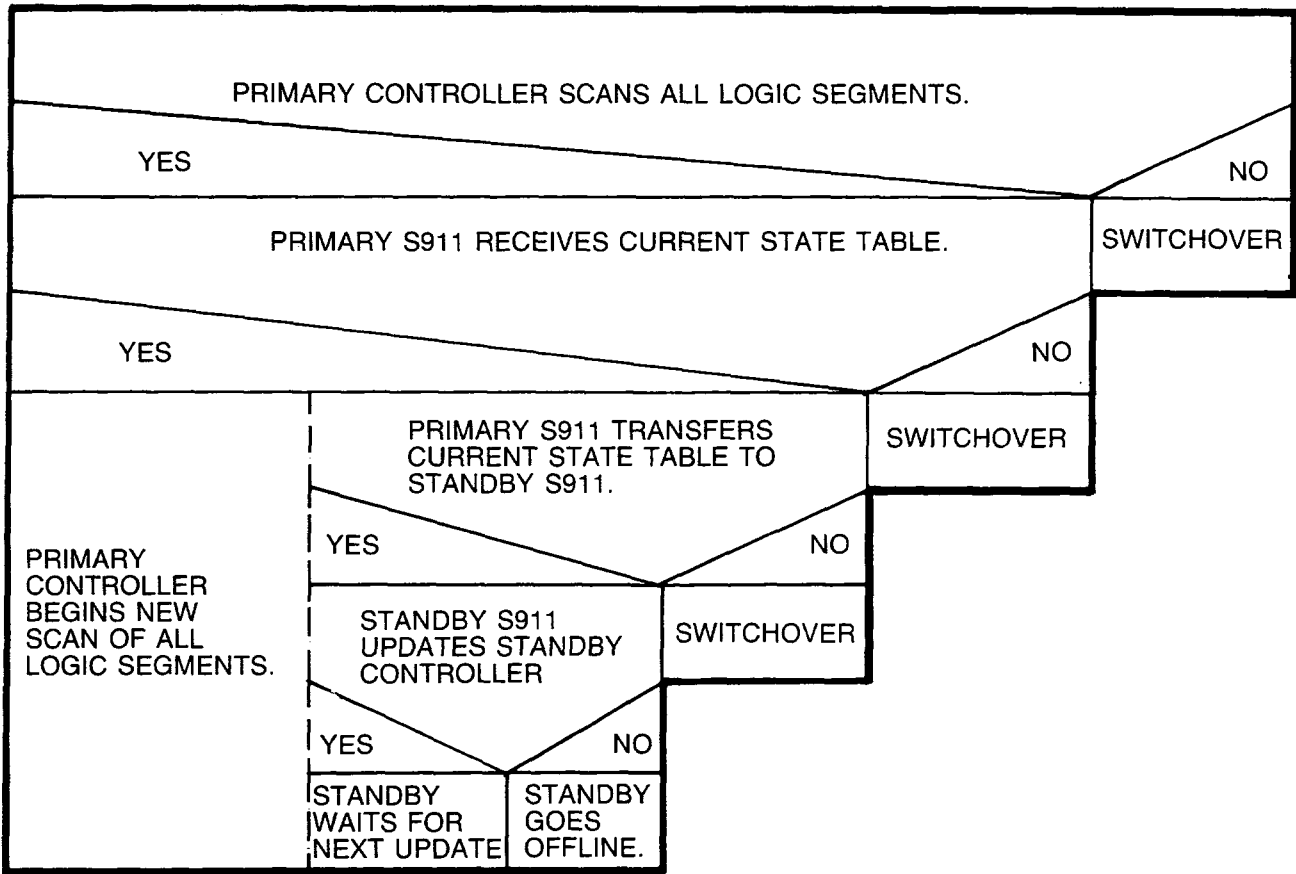

# Hardware Components in a Hot Standby System

---

The 984 hot standby capability can be implemented in any of four types of PC mainframes. The key hardware element in a hot standby configuration is the S911 hot standby module.

## Four Types of 984 Mainframes

A 984 Hot Standby System consists of two PC mainframes that control 800-series remote I/O. Local I/O is not supported. Hot standby capability can be achieved in four types of 984 mainframes:

- the 984A
- the 984B
- the 984X
- the 984-680

## 984 Hot Standby Hardware

A 984 Hot Standby System requires two chassis, each set up with an identical

- Power supply
- Comm processor
- Memory
- CPU
- Remote I/O processor
- Hot standby module

Your Hot Standby System also includes a redundancy terminator kit (for interconnecting the two remote I/O processors) and a length of W911 cable (for interconnecting the two S911 hot standby modules).

Table 1-1 lists the modules used in each of the four 984 mainframes that comprise a minimum hot standby hardware configuration.

Table 1-1

984 Minimum Hardware Configurations

	Power	Comm	Mem	CPU	I/O	HSBY
A	P930/P933	C921	M907-XXX	C916-100	S908-0XX	S911-000
B	P930/P933	C921	M909-XXX	C924	S908-0XX	S911-000
X	P930	S929	S929	C916-120	S929	S911-000
680	984-680	984-680	984-680	984-680	S908-110	S911-800



- ▶ **NOTE** The comm processing, memory, and remote I/O processing functions are all performed by the *S929 multi-option processor* module in a 984X. Power supply, comm processing, memory, and CPU are all performed by the *984-680 module*.
- ▶ **NOTE** The S911-800 and the S908-110 modules are smaller than the S911-000 and S908-0XX modules; they are designed to fit into AS-H819-209 or AS-H827-209 housings.

### ***Increasing Power for Additional Option Modules***

A P930 power supply module in the seven-slot chassis that houses a 984A or 984B mainframe can handle the power requirements of a basic module configuration along with an optional S978 dual modem and one other option module. In the case of a Hot Standby System, the S911 hot standby module is that extra option module.

If your 984A or 984B Hot Standby System includes more option modules, use a P933 power supply. The P933 supports any *three* of these options:

- a C986 Coprocessor
- an S911 Hot Standby processor
- an S975 MODBUS II
- an S978 Dual Modem

A P930 power supply in the four-slot chassis that houses the 984X mainframe can support any two of the above option modules.

- ▶ **CAUTION** A 984 Hot Standby module does not automatically switch over control of *option module* processes. For a discussion of the software needed to force this kind of switchover, see Chapter 4 of the *984 Hot Standby System Programming Guide*.

### ***Communication Between Primary and Standby Modules***

In a Hot Standby System the remote I/O processors and the S911 hot standby modules in the primary and standby controllers must communicate with each other.

The S911's communicate through W911 cable. The remote I/O processors communicate over a cable assembly made suitable for the Hot Standby System by using the components in the redundancy terminator kit.

# The S911 Hot Standby Module

Two S911 hot standby modules, one in each controller, form the functional center of a 984 Hot Standby System. Each S911 monitors its own controller and communicates with the S911 module in the other controller.

## Two Versions of the S911 Hot Standby Module

The S911 hot standby module comes in two sizes - the S911-000, which fits in the chassis for the 984A/B/X controllers, and the S911-800, which fits in the housings for the 984-680 controllers.

Figure 1-2 shows the differences and similarities between the two S911 modules.

Figure 1-2

S911 Hot Standby Modules

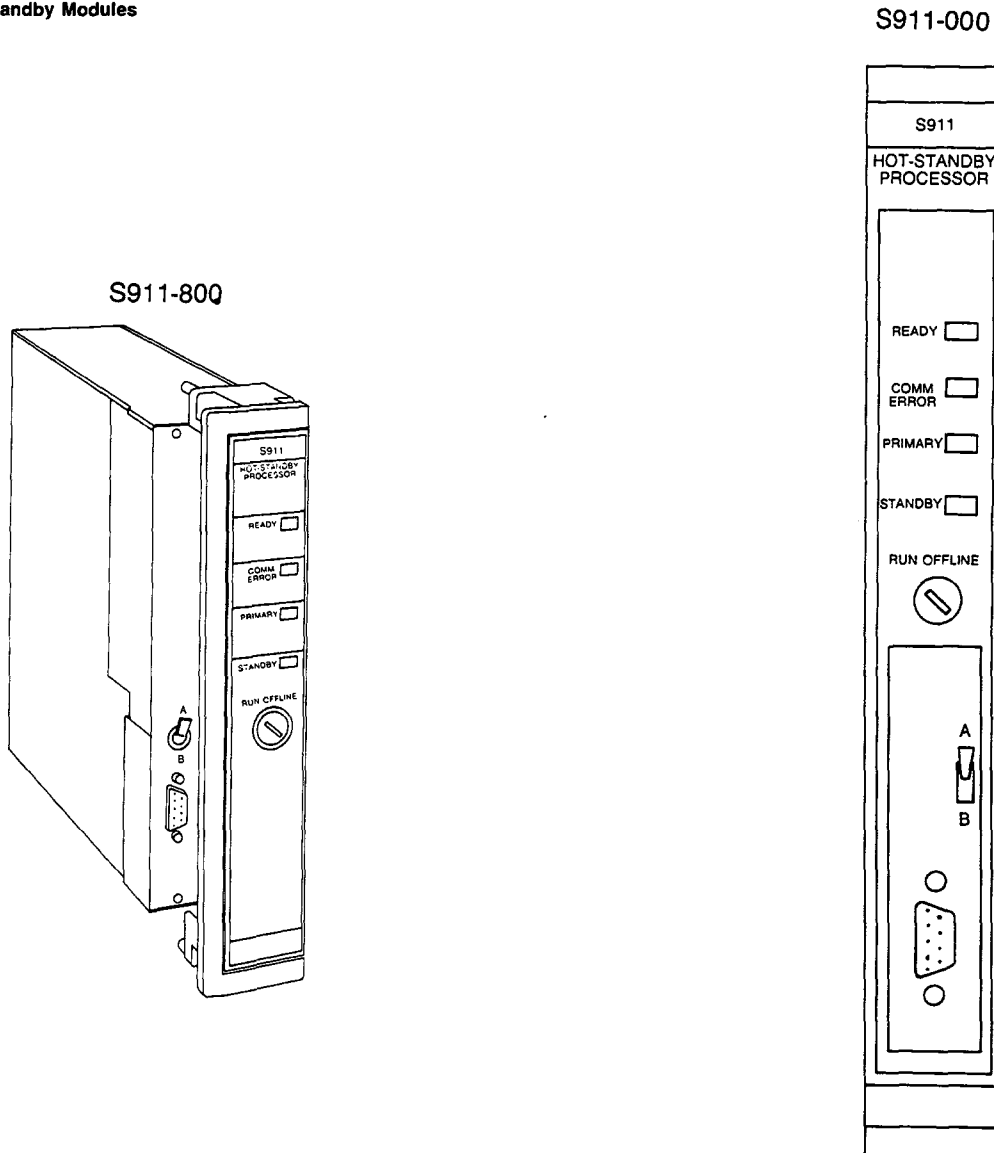

## ***LED Displays***

On the face of each S911 control panel are four light emitting diodes (LED's):

- READY, a green LED indicating the general health of the system
- COMM ERROR, a red LED indicating that a communication error is being experienced
- PRIMARY, a green LED indicating that the controller is operating in primary mode
- STANDBY, a green LED indicating that the controller is operating in standby mode

## ***Keyswitches***

Beneath the LED's on the face of each S911 control panel is a keyswitch that lets you select RUN or OFFLINE modes for a controller.

You can use these keyswitches to force manually controlled switchovers for troubleshooting and maintenance. If you take the primary controller OFFLINE, the standby switches to primary mode. If you take the standby controller OFFLINE, the primary functions as a standalone.

## ***Toggle Switches and W911 Cable Connections***

The S911 module in the 984A/B/X mainframes has a recessed area on the front panel containing a toggle switch and a W911 cable connection. The S911 module in the 984-680 mainframe has a recessed panel to the left of the face panel containing the toggle switch and cable connection.

The toggle switches on the primary and standby S911's must be set in different positions (one in position A and the other in position B). The position of the toggle switches helps determine which controller is primary when both controllers power up simultaneously. The Hot Standby System will indicate a startup error if the switches are in the same position.

The two S911 modules are interconnected with W911 cable. This cable plugs in to the nine-pin redundancy cable connections on each S911 module.

# 984 Remote I/O Processors

Depending on the type of 984 mainframes you are configuring, you will deal with one of three types of remote I/O processors. Interconnect the remote I/O processors in the primary and standby processors with a cable assembly made suitable for your Hot Standby System with the components in the redundancy terminator kit.

## Three Types of 984 Remote I/O Processors

Figure 1-3 below shows the three types of remote I/O modules used in 984 Hot Standby Systems. The S908-0XX is used in 984A and 984B controllers; the S908-110 is used with 984-680 controllers; the S929 multi-option module performs remote I/O processing as well as other processing tasks in 984X controllers.

Figure 1-3

984 Remote I/O Processors

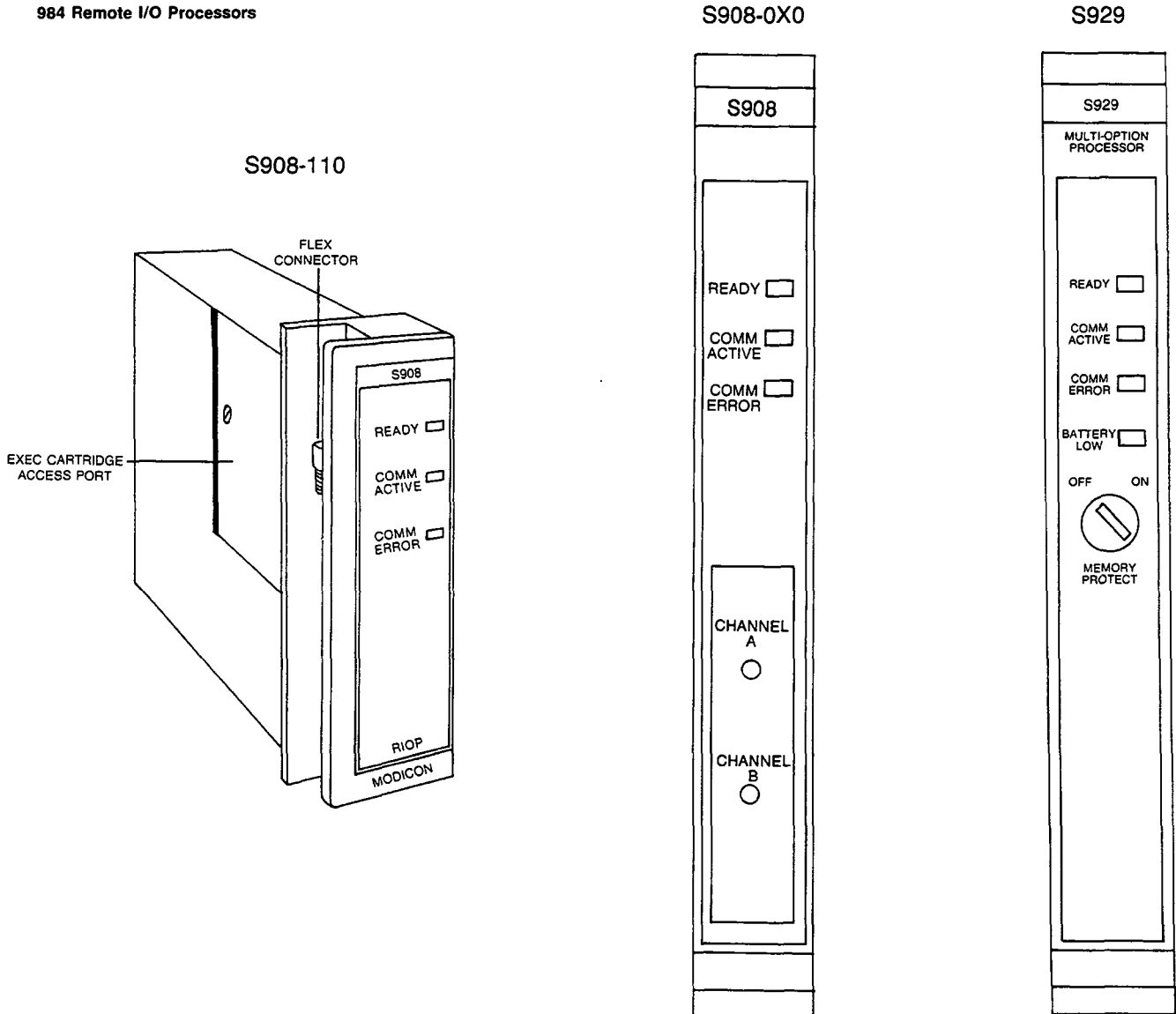

## ***LED Displays***

All three remote I/O processors have three LED displays on the front of their control panels:

- **READY**, a green LED indicating the general health of the system
- **COMM ACTIVE**, a green LED indicating the general health of the remote I/O communication link
- **COMM ERROR**, a red LED indicating that a communication error is being experienced

The S929 multi-option module also has a red LED that illuminates when the battery is low.

## ***Cable Connections***

The S908-0XX module has cable connectors in a recessed area on the front panel. The S908-110 module has cable connectors on the left sidewall. Both S908 modules shown in figure 1-3 have connectors for dual cable hookups (channel A and channel B). S908 modules are also available with single-cable connector.

The S929 multi-option processor has a cable connector on the bottom of the module. The S929 permits only a single cable connection.

## ***Dual and Redundant Cable Options***

The S908-0XX and S908-1XX modules have dual and redundant cabling options. This allows you to increase communication reliability by routing two separate cable assemblies the remote I/O drops. When dual or redundant cables are used, each cable assembly must facilitate communication between the primary and standby controllers; this requires a second redundancy terminator kit.

These cabling strategies require dual cable ports on the S908 module; this feature is available with the 984A, 984B, and 984-680 controllers. The S929 multi-option processor in the 984X controllers does not support dual cabling.

## End User Part Numbers

---

The four tables that follow give you the end user part numbers and descriptions for the components in the various 984 Hot Standby Systems available.

Table 1-2

984A Hot Standby End User  
Part Numbers

Quantity	Part Number	Description
2	P2-984A-8XX P5-984A-9XX	Module set with single I/O cable . . . . . with dual I/O cables Set includes:
2	C916	CPU's
2	C921	Comm processors
2	S908	Remote I/O processors
2	M907	Memory boards
2	P930-007	Low power seven-slot chassis
2	P933-007	Full power seven-slot chassis
1	911K-006 911K-012 911K-030	Redundancy Kit with 6-foot W911 cable . . . . . with 12-foot W911 cable . . . . . with 30-foot W911 cable Kit includes:
2	S911-000	Hot standby processors
1	W911-0xx	Hot standby cable
1	911T-KIT	Redundancy Terminator Kit
1	SW-AP9X-RXA	Hot Standby Software Kit

Table 1-3

984B Hot Standby End User  
Part Numbers

Quantity	Part Number	Description
2	P2-984B-8XX P5-984B-9XX	Module set with single I/O cable . . . . . with dual I/O cables Set includes:
2	C924	CPU's
2	C921	Comm processors
2	S908	Remote I/O processors
2	M909	Memory boards
2	P930-007	Low power seven-slot chassis
2	P933-007	Full power seven-slot chassis
1	911K-006 911K-012 911K-030	Redundancy Kit with 6-foot W911 cable . . . . . with 12-foot W911 cable . . . . . with 30-foot W911 cable Kit includes:
2	S911-000	Hot standby processors
1	W911-0xx	Hot standby cable
1	911T-KIT	Redundancy Terminator Kit
1	SW-AP9X-RXA	Hot Standby Software Kit

Table 1-4

984X Hot Standby End User  
Part Numbers

Quantity	Part Number	Description
2	P1-984X-008	Module set with single I/O cable Set includes:
2	C916	CPU's
2	S929	Multi-option processors
2	P930-004	Four-slot chassis
1	911K-006	Redundancy Kit with 6-foot W911 cable
	911K-012	..... with 12-foot W911 cable
	911K-030	..... with 30-foot W911 cable
		Kit includes:
2	S911-000	Hot standby processors
1	W911-0xx	Hot standby cable
1	911T-KIT	Redundancy Terminator Kit
1	SW-AP9X-RXA	Hot Standby Software Kit

Table 1-5

984-680 Hot Standby End  
User Part Numbers

Quantity	Part Number	Description
2	H819-209	19 in housings
	H827-209	27 in housings
2	PC-0984-680	Controller
2	E680-90x	984-680 Executive cartridge
2	M680-0xx	984-680 Memory cartridge
2	S908-110	I/O processors with single I/O cable
	S908-120	I/O processors with dual I/O cables
2	E908-0xx	S908 Executive Cartridge
1	911K-806	Redundancy Kit with 6-foot W911 cable
	911K-812	..... with 12-foot W911 cable
	911K-830	..... with 30-foot W911 cable
		Kit includes:
2	S911-800	Hot standby processors
1	W911-0xx	Hot standby cable
1	911T-KIT	Redundancy Terminator Kit
1	SW-AP98-RXA	Hot Standby Software Kit





# **Chapter 2**

## **Planning**

---

- Some General and Specific Planning Guidelines
- Planning a New Hot Standby System
- Planning a Retrofit Hot Standby System
- Optional Hardware Configurations

## ***Some General and Specific Planning Guidelines***

---

We have designed and built the 984 Hot Standby System for use in demanding industrial environments. Nonetheless, you must plan the installation carefully to help assure system reliability.

### ***Standard Planning Guidelines***

Both the primary and the standby controller in your Hot Standby System must be ready to perform as a *standalone* controller in the event that its partner fails. You should therefore install both mainframes with equal care according to MODICON's standard planning and installation guidelines.

If you are planning the installation of a 984A, 984B, or 984X Hot Standby System, refer to the *984 PC System Planning and Installation Guide* (GM-0984-003) for specific details.

If you are planning the installation of a 984-680 Hot Standby System, refer to the *984-680 PC System Planning and Installation Guide* (GM-0984-101) for specific details.

Design your system first for safety, then for economy. Make sure that you understand all the cautions and warnings in this documentation before you begin to install your Hot Standby System.

### ***Environment***

984 Hot Standby System components function in a temperature range of 32 to 140°F (0 to 60°C) and a humidity range of 0 to 95% (noncondensing). We recommend that you install your 984 Hot Standby System components in the coolest possible areas.

### ***Local I/O Restriction***

984 Hot Standby Systems do not support local I/O. If your primary controller is set up to run local I/O and a switchover occurs, the local I/O will *not* be controlled when the standby takes over.

Never plan to control critical I/O locally.

## ***Planning a New Hot Standby System***

---

If you are planning to install a *new* Hot Standby System, adhere to the following requirements and recommendations.

### ***Requirements***

- When you plan the installation of the electrical cabinets that enclose the system's electronic components, make sure each cabinet is connected separately to earth ground and that each chassis is connected to a solid ground within its cabinet.
- ▶ **WARNING** To help protect yourself and others against electric shock, obey the National Electrical Code and all applicable local codes and laws. The National Electrical Code is detailed in the National Fire Protection Association's publication NFPA 70-1984 (or latest edition).
- The two mainframes should be less than 30 feet (9.14 meters) from each other. The distance is constrained by the length of the W911 cable (which has a maximum length of 30 feet). Do not exceed the maximum specified length for any cable.
- ▶ **CAUTION** The 984 Hot Standby System does not support local I/O. Make sure your plan handles all application devices from remote I/O drops.

### ***Recommendations***

- Make and maintain accurate drawings of the system component and cable layout.
- Install a separate disconnect switch for each controller. This will allow you to remove one controller without having to shut down the system.
- Use one type of mounting hardware consistently throughout the system.
- If you must install the controllers in a hard-to-reach location, consider ways to use the optional system control techniques described in the *984 Hot Standby Programming Manual*.

## **Planning a Retrofit Hot Standby System**

---

If you are planning to upgrade an existing 984 standalone system with a hot standby capability, you will need two S911 hot standby modules and a second control system; the modules must be identical to those in the current standalone system. Depending on the current system, you may need one or two 0984 PC chassis.

### **Additional Planning Considerations**

When planning a retrofit Hot Standby System, all of the issues described in the previous section must be taken into consideration. In addition, you must check all the modules in the standalone controller to make sure they are compatible with the S911 hot standby module.

Check the specifications of your current system against those in table 2-1 to assure product compatibility.

---

Table 2-1

**Hot Standby Compatibility Specifications**

	<b>Power Supply</b>	<b>CPU</b>	<b>Executive</b>	<b>Remote I/O</b>
984A	P930-007 or P933-007	C916/PROM combo 2002 (Rev C) or higher	AS-S902-051 PROM combo 2003 or higher	S908/PROM combo 1002 (Rev D) or higher
984B	P930-007 or P933-007	C924/PROM combo 1002 (Rev C) or higher	AS-S902-061 PROM combo 1003 or higher	S908/PROM combo 1002 (Rev D) or higher
984X	P930-104	C916/micro-code code PROM combo 1003 (Rev D) or higher	S929/PROM combo 1002 (Rev C) or higher	S929/PROM combo 1004 (Rev D) or higher
680	680 Rev B or higher	680 Rev B or higher	E680 Rev B or higher	S908 Rev B or higher

If you are in doubt about the revision levels, contact our Customer Support Center at 1-800-468-5342, or 1-(508)-975-5001 in Massachusetts or outside North America.

## ***Increasing Power for Additional Option Modules***

A P930 power supply module in the seven-slot chassis that houses a 984A or 984B mainframe can handle the power requirements of a basic module configuration along with an optional S978 dual modem and one other option module. In the case of a Hot Standby System, the S911 hot standby module is that extra option module.

If your 984A or 984B Hot Standby System is going to include more option modules, you will need a P933 power supply. The P933 supports any three of these options:

- a C986 Coprocessor
- an S911 Hot Standby processor
- an S975 MODBUS II
- an S978 Dual Modem

A P930 power supply in the four-slot chassis that houses the 984X mainframe can support any two of the above option modules (in a Hot Standby System, an S911 module and one other option module).

- ▶ **CAUTION** A 984 Hot Standby System does not automatically switch over control of option module processes. For a discussion of the *soft control* needed to force this kind of switchover, see Chapter 4 of the *984 Hot Standby System Programming Guide*.

Power supply, CPU, and executive functions are all handled by the 984-680 module.

## ***Optional Hardware Configurations***

---

Some optional configurations will affect your Hot Standby System – i.e., dual and remote cabling to remote I/O drops and optional system control setups at an I/O drop.

### ***Dual and Redundant Cabling to Remote I/O Drops***

If you use a dual-port S908 processor in your PC mainframe you can support dual or redundant cabling strategies with a 984A, 984B, and 984-680 Hot Standby System. If you plan to install dual or redundant cables – even if at a later date – carefully determine where each cable path will run.

If possible, provide separate conduits for each cable line that will run parallel. This increases the chances that I/O communications will continue if a line is damaged.

Dual and redundant cable strategies require a second redundancy terminator kit. The components in the terminator kit are used to assemble cables with hot standby capability.

- ▶ **NOTE** The S929 multi-option processor module, which support I/O processing for the 984X mainframe, has only one remote I/O port. Therefore, a 984X Hot Standby System cannot have dual or redundant I/O cables.

### ***Optional System Control***

You may choose to design some form of optional system control for your Hot Standby System. This allows you to duplicate the keyswitch functions of the S911 modules at a remote I/O drop. It also allows you, according to your needs, to monitor and control other functions of your Hot Standby System.

For more information, refer to the *984 Hot Standby System Programming Manual*.

# **Chapter 3**

## **Installations**

---

- Chassis for the 984A or 984B Mainframes
- Chassis for the 984X Mainframes
- Housings for the 984-680 Mainframes
- The Redundancy Terminator Kit
- 984 Hot Standby Installation Procedures
- 984 Hot Standby System Diagrams
- Redundant Remote I/O Cabling in an HSBY System
- Dual Remote I/O Cabling in an HSBY System
- Installing Redundant Remote Cables
- Installing Dual Remote Cables

## Chassis for the 984A or 984B Mainframes

Two PC 0984 *seven-slot* chassis support 984A and 984B Hot Standby hardware. Each chassis contains a power supply in the first slot, followed by the standard 984 PC modules and an S911 option module. The S911 module (and any other option module) goes into one of the three option slots (slots 2, 6, or 7). The standard PC modules can be arranged in any order in the other slots.

### 984A Hardware Configuration

If you are installing a 984A Hot Standby System, your system will comprise two PC 0984 seven-slot chassis with identical modules in each. As a minimum, each chassis houses a P930 power supply and five modules: a C921 comm processor, an M907 memory, a C916-100 CPU, an S908 remote I/O processor, and an S911 hot standby module.

Figure 3-1 shows a typical 984A Hot Standby configuration. The S911 is in option slot 6; the other two option slots – slots 2 and 7 – are available for other option modules. (If you use additional option modules, you may need to use the P933 power supply.)

Figure 3-1

984A Hot Standby  
Hardware Configuration

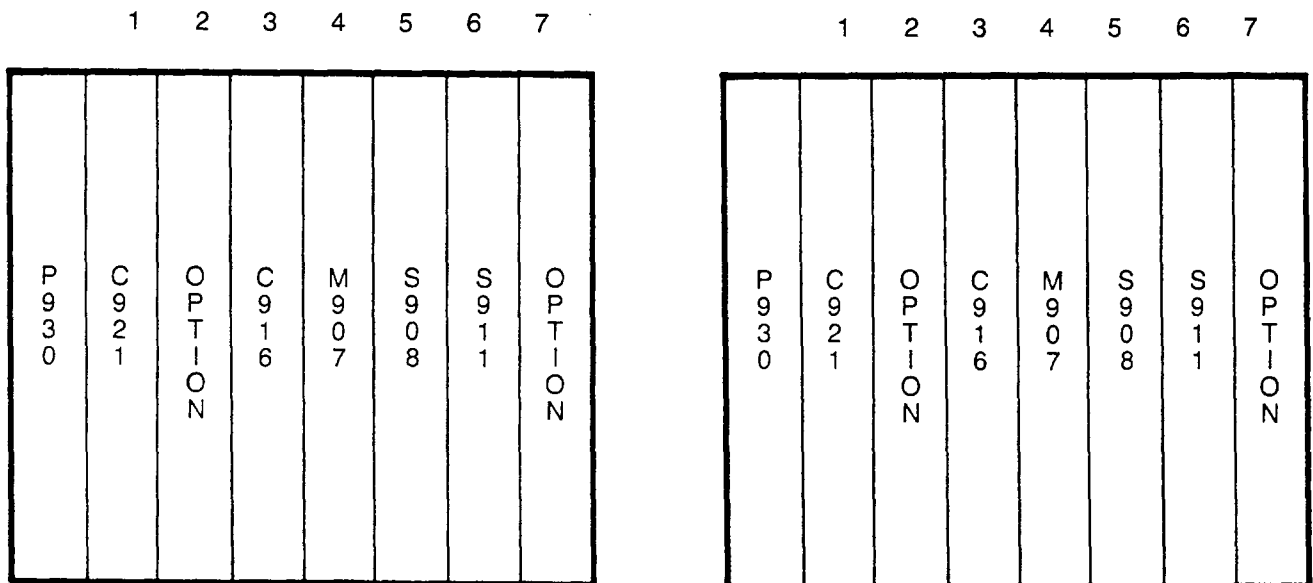



## 984B Hardware Configuration

If you are installing a 984B Hot Standby System, your system will comprise two PC 0984 seven-slot chassis with identical modules in each. A minimum hardware configuration in each chassis includes a P930 power supply and five modules: a C921 comm processor, an M909 memory, a C924 CPU, an S908 remote I/O processor, and an S911 hot standby module.

Figure 3-2 shows a typical 984B Hot Standby configuration.

Figure 3-2

984B Hot Standby  
Hardware Configuration

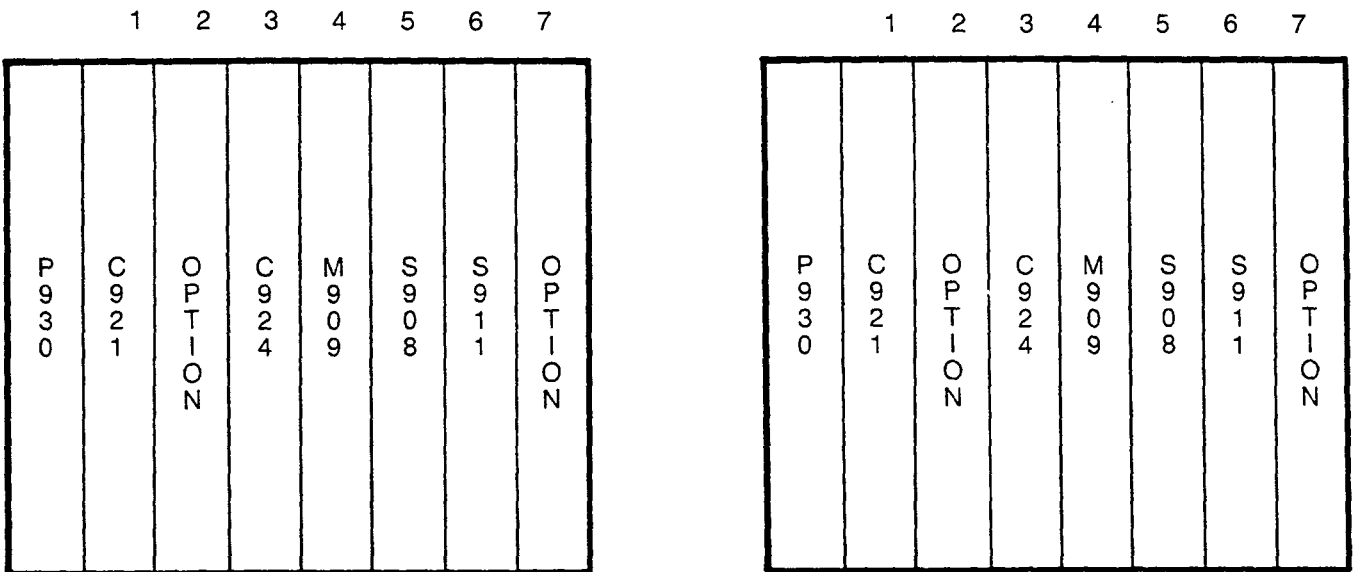

## Chassis for the 984X Mainframes

Two PC 0984 *four-slot* chassis support the 984X Hot Standby hardware. Each chassis contains a P930 power supply and four module slots. The S911 hot standby module (and any other option module) goes in one of the two option slots (slots 1 or 2). The other modules can be arranged in any order in the other slots.

### 984X Hardware Configuration

Each 984X Hot Standby System comprises two PC 0984 four-module chassis. As a minimum, each chassis must contain a P930 power supply and three modules: an S911 hot standby module, an S929 multi-option processor, and a C916-120 CPU.

Figure 3-3 shows a typical 984X Hot Standby configuration. The S911 is housed in option slot 2; option slot 1 is open.

Figure 3-3

984X Hot Standby  
Hardware Configuration

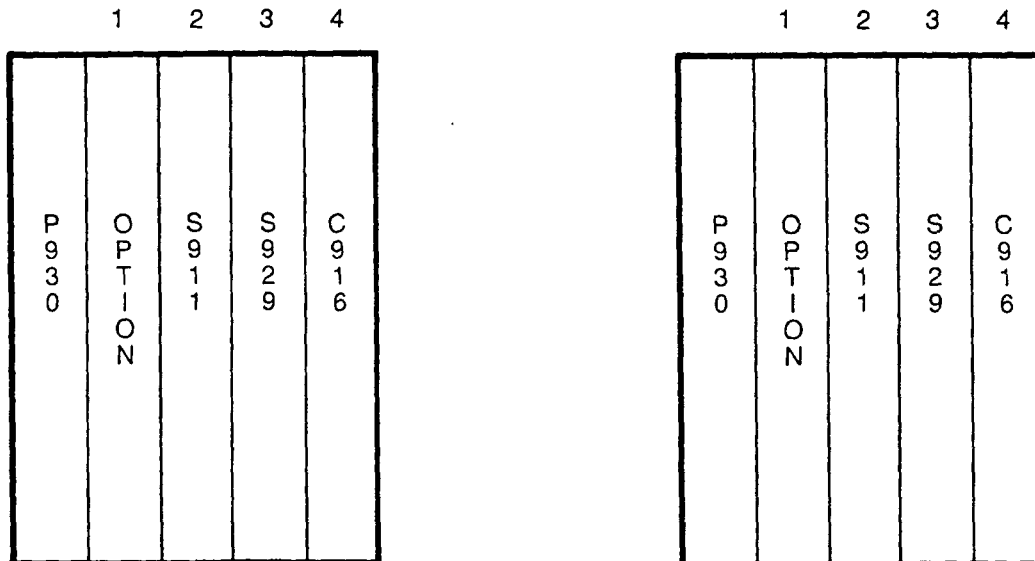

# Housings for the 984-680 Mainframes

The 984-680 Hot Standby modules can be housed in either a 19-inch or 27-inch chassis. The one-and-a-half-slot 984-680 power supply/CPU goes in slots 1 and 2. The S911 hot standby module can go in any of the next five slots.

## Basic Hardware Configuration

Each 984-680 Hot Standby System is enclosed in an 800-series primary housing (MODICON P/N H819-209 or H927-209). As a minimum, each housing holds three modules: a 984-680 controller module, an S911-800 hot standby module, and an S908-110 remote I/O processor.

Figure 3-4 shows a typical 984-680 Hot Standby configuration in a seven-slot (19-inch) housing.

Figure 3-4

984-680 Hot Standby  
Hardware Configuration

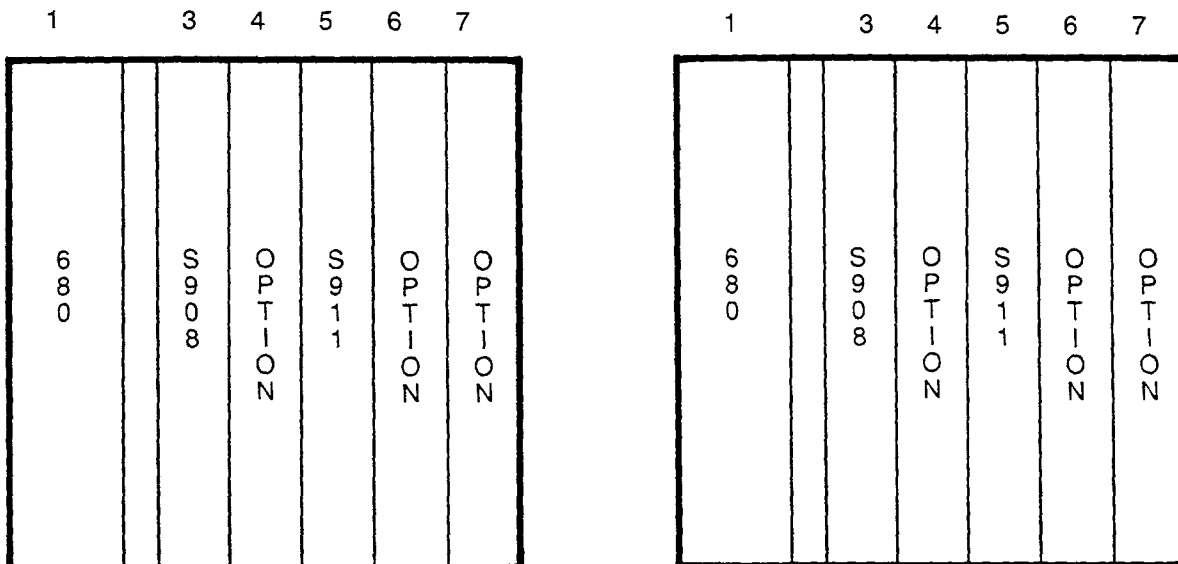

# The Redundancy Terminator Kit

A redundancy terminator kit is included with your shipment. The components in this kit provide the redundancy capability between the two remote I/O processors in your Hot Standby System.

## In-line Terminator Components

A redundancy terminator kit contains the following components:

- 1 communications splitter
- 2 in-line 75 Ohm terminators
- 2 1/2-inch shrink wrap tubes
- 2 3/4-inch shrink wrap tubes
- 2 instruction labels

You need one redundancy terminator kit for each trunk line.

## Assembling the Redundancy Terminator Kit

Assemble the components in the redundancy terminator kit with the coaxial cable that interconnects the two remote I/O modules. Refer to figure 3-5 during assembly.

Figure 3-5

### Redundancy Terminator Components

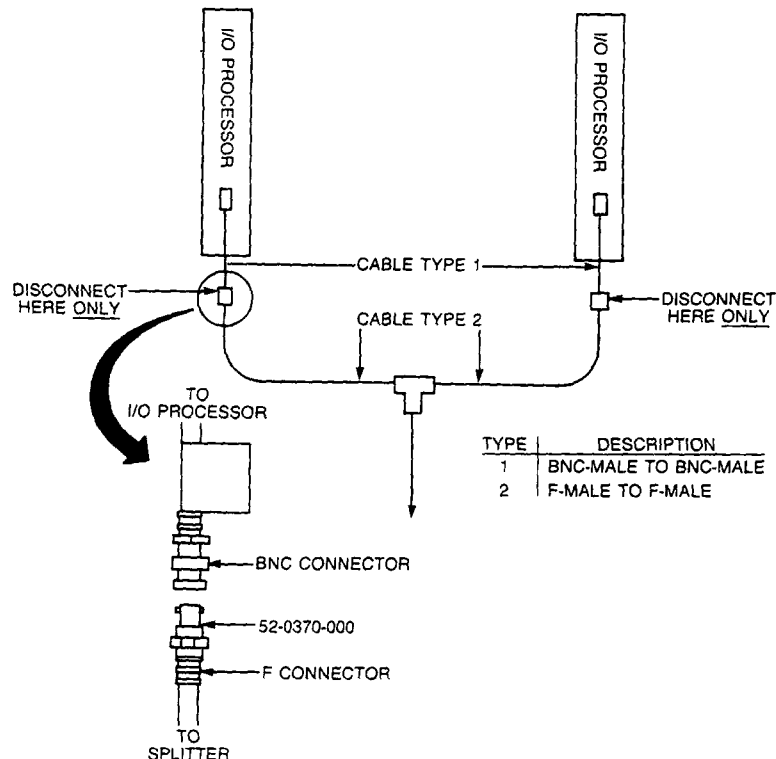

## **Procedure**     **Assembling Remote I/O Cables with Terminator Kit**

- Step 1**     Fasten male F-type connectors to each end of a coaxial cable.
- Step 2**     Connect one end of the cable to the splitter (MA-0186-000).
- Step 3**     Slide a 1/2-inch shrink wrap tube over the other end of the cable.
- Step 4**     Connect this end of the cable to the in-line terminator (52-0370-000).
- Step 5**     Slide a 3/4-inch shrink wrap tube over the open end (the BNC connector) of the in-line terminator.
- Step 6**     Apply heat to shrink the 3/4-inch tube onto the cable (up to but not covering the BNC connector).
- Step 7**     Apply heat to shrink the 1/2-inch tube onto the cable and over the 3/4-inch tube.
- Step 8**     After the tubing has cooled, place a stick-on instruction label over it.
- Step 9**     If you are installing a 984A/B/X Hot Standby System, attach male BNC connectors to both ends of the coaxial cable. If you are installing a 984-680 system, attach a male BNC connector to one end of the coaxial cable and a male F-type connector (52-0403-000) to the other end.
- Step 10**    Connect one end of the cable (with a BNC connector on it) to the in-line terminator. Connect the other end of the cable (with either the F-type connector or a BNC connector on it) to the remote I/O module in the primary controller.
- Step 11**    Repeat this procedure to hook up a BNC cable to the remote I/O module in the standby controller.
- Step 12**    If you are installing a dual cable system to your remote I/O drops, obtain a second terminator kit and repeat steps 1-9.

You must disconnect the coaxial cable from the BNC end of the terminator first. This engages the mechanical termination, allows for secure I/O communications, and leaves the terminator on the cable.

## **984 Hot Standby System Installation Procedures**

---

Follow the procedures below to install a 984A, a 984B, a 984X, or a 984-680 Hot Standby System.

### **Procedure    *Installing a 984 Hot Standby System***

- Step 1**    Open and padlock open all disconnect switches in all circuits that provide power to the controllers.
- ▶ **WARNING**    To help protect yourself and others against electric shock, open and padlock open all system power disconnect switches before making high voltage connections at the power supplies and I/O terminals.
  - ▶ **CAUTION**    To help avoid damage to system components, de-energize the system completely before installing modules and cables.
- Step 2**    Mount both chassis and all remote I/O module housings in the appropriate electrical cabinets.
- Step 3**    Insert an S911 hot standby module into an option slot in both chassis.
- ▶ **NOTE**    Make sure that the S911 toggle switch in one controller is in the A position and the S911 toggle switch in the other controller is in the B position.
  - ▶ **NOTE**    Before replacing a blank bezel with a mainframe module, remove the module slot RF shield at the bottom of the chassis.
- Step 4**    Interconnect the S911 modules with W911 cable. This cable is available in three lengths: 6 ft (1.83 m), 12 ft (3.66 m), or 30 ft (9.14 m).
- Step 5**    Connect the A channels of both remote I/O modules through MODICON 52-0370-000 in-line terminators and equal lengths of I/O cable – 15 ft (4.57 m) maximum for each module – to a single MODICON line splitter (MA-0186-000).

**Step 6** Connect the line splitter to the A channels in the J890/J892 modules at all the remote I/O drops. Use remote I/O cables, MODICON line taps, and external feed-through terminators (60-0513-000).

- ▶ **NOTE** S908 and S929 modules get self-terminating connectors – when connected, power flows straight through; when disconnected, a 75-Ohm resistor swings in and keeps the cable terminated. The J890/892's get a fixed-resistor terminator that is always on; they have no internal termination.

**Step 7** Install a type TR-75F cable terminator at the last line tap.

**Step 8** Unlock and close all system disconnect switches.

**Step 9** Test all remote I/O cables according to the *984 PC System Planning and Installation Guide* (GM-0984-003).

The illustrations on the next two pages show block diagrams of correctly assembled 984 Hot Standby Systems.

# 984 Hot Standby System Diagrams

Figures 3-6 through 3-9 show diagrams of the four 984 PC mainframes correctly assembled for hot standby capabilities.

Figure 3-6

984A Hot Standby System Diagram

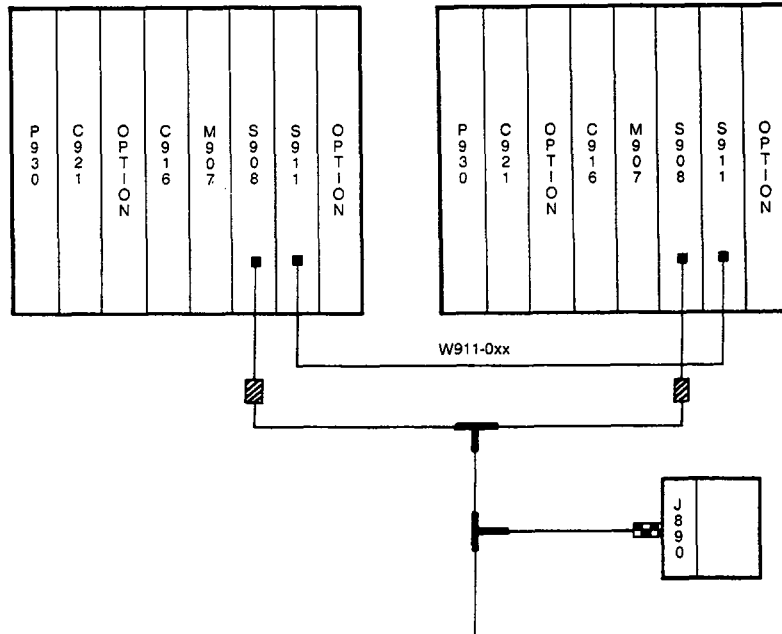

Figure 3-7

984B Hot Standby System Diagram

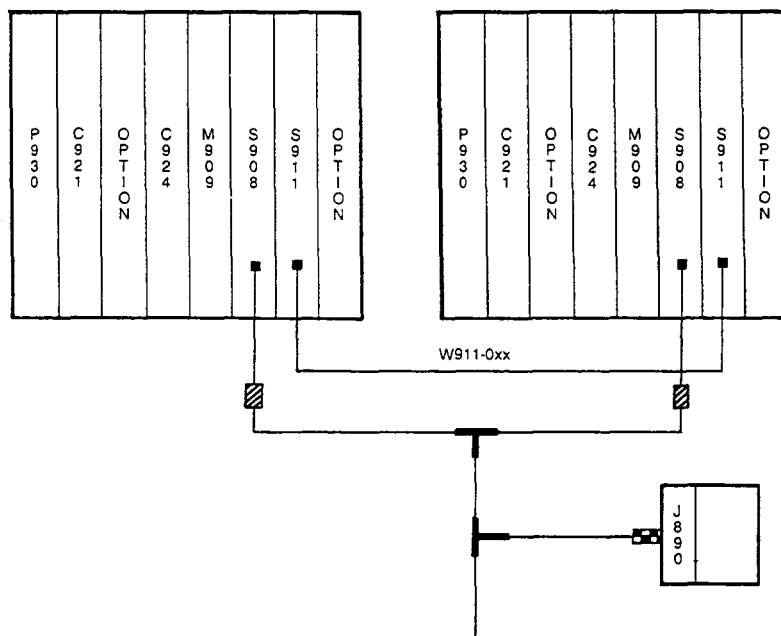



Figure 3-8

984X Hot Standby System Diagram

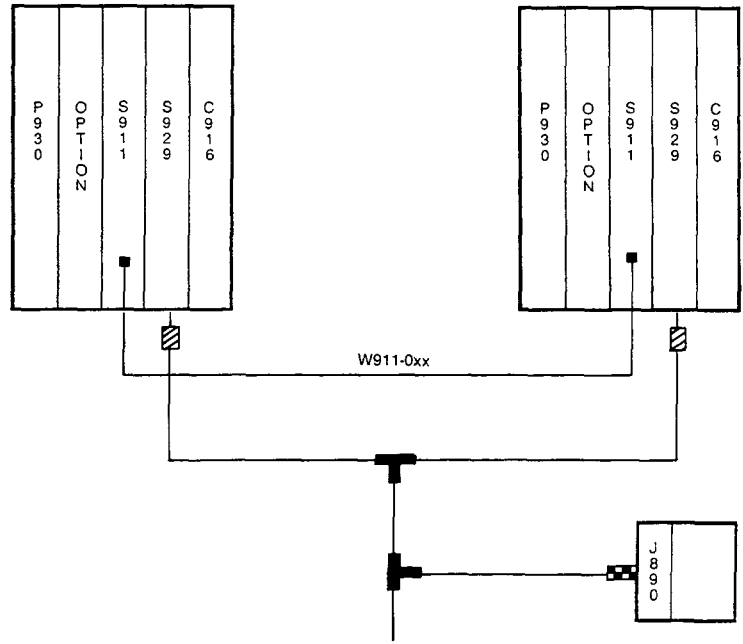
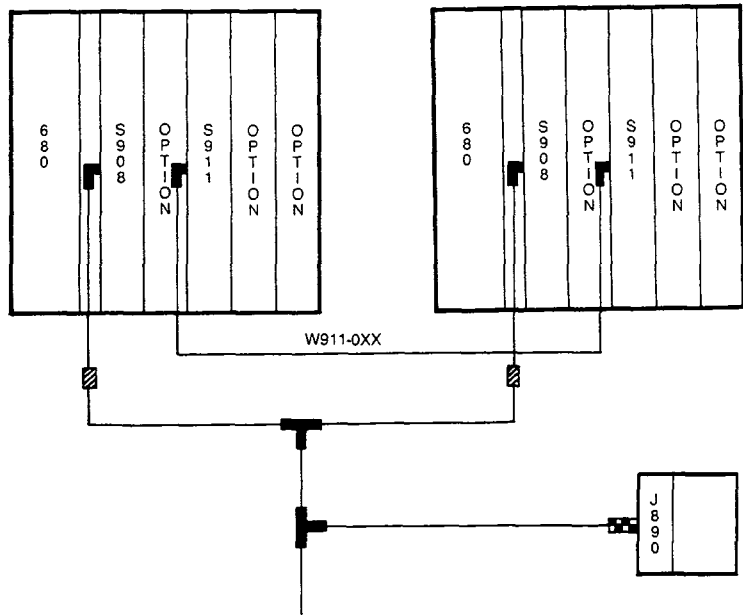

Figure 3-9

984-680 Hot Standby System Diagram



## Redundant Remote I/O Cabling in an HSBY System

You can run redundant remote I/O cables from the PC mainframes in your Hot Standby System. Redundant cables run in parallel to the same I/O drops. Both parallel trunk cables must be run through splitters.

- **NOTE** A redundant cable strategy requires a dual-port S908 processor in each PC; this is available with the 984A, 984B, and 984-680 systems. The 984X Hot Standby System does *not* support redundant cabling.

Figures 3-10 through 3-12 show diagrams of the three 984 Hot Standby System configurations that implement redundant cabling to the remote I/O drops.

Figure 3-10

Redundant I/O Cables for a  
984A Hot Standby System

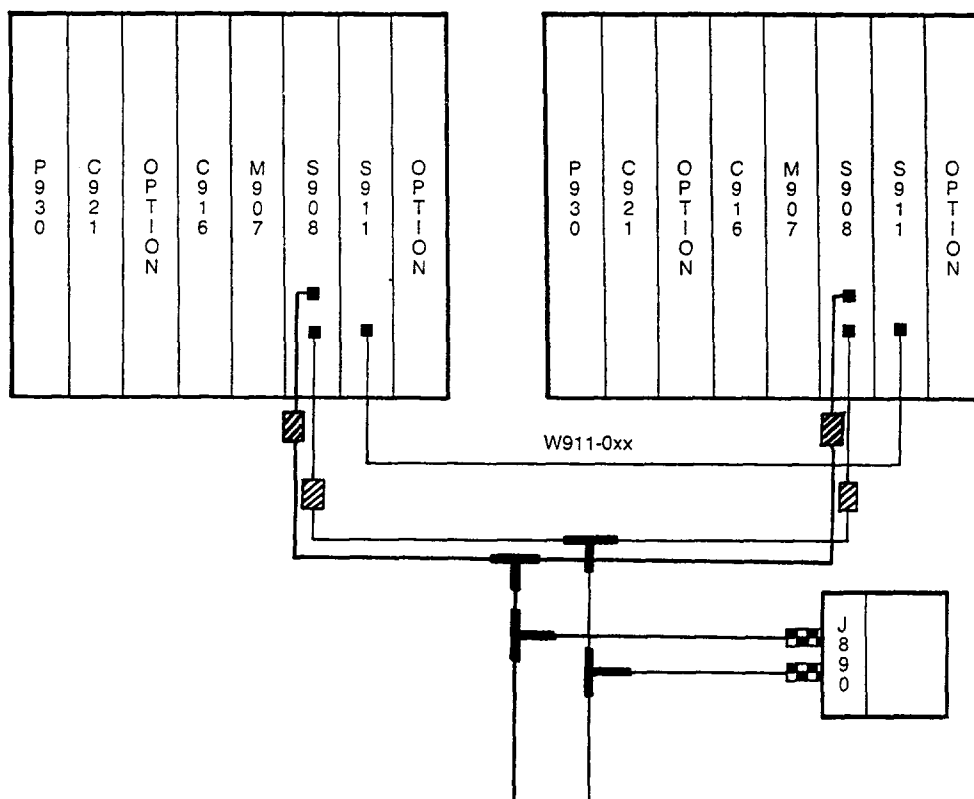

Figure 3-11

Redundant I/O Cables for a  
984B Hot Standby System

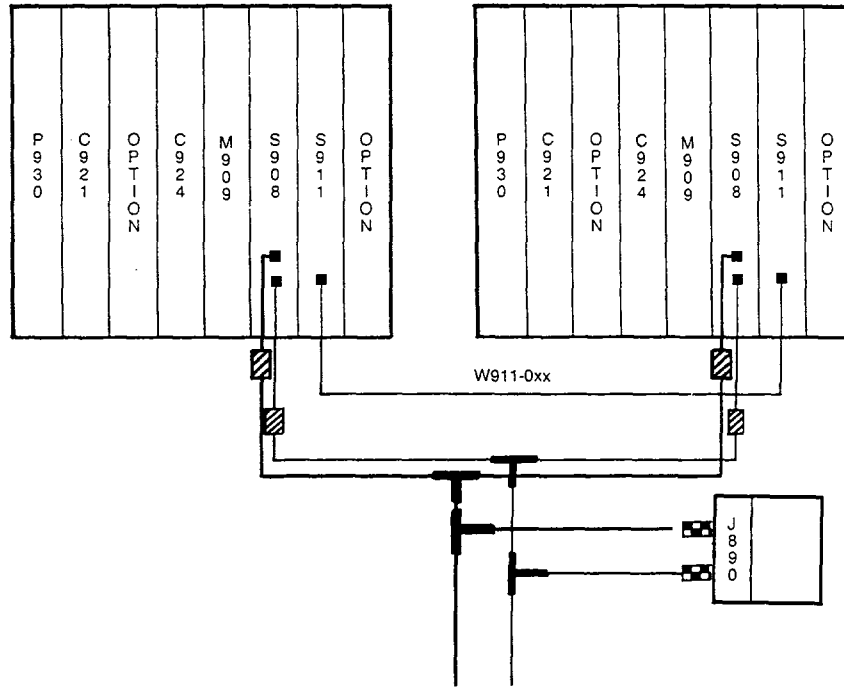
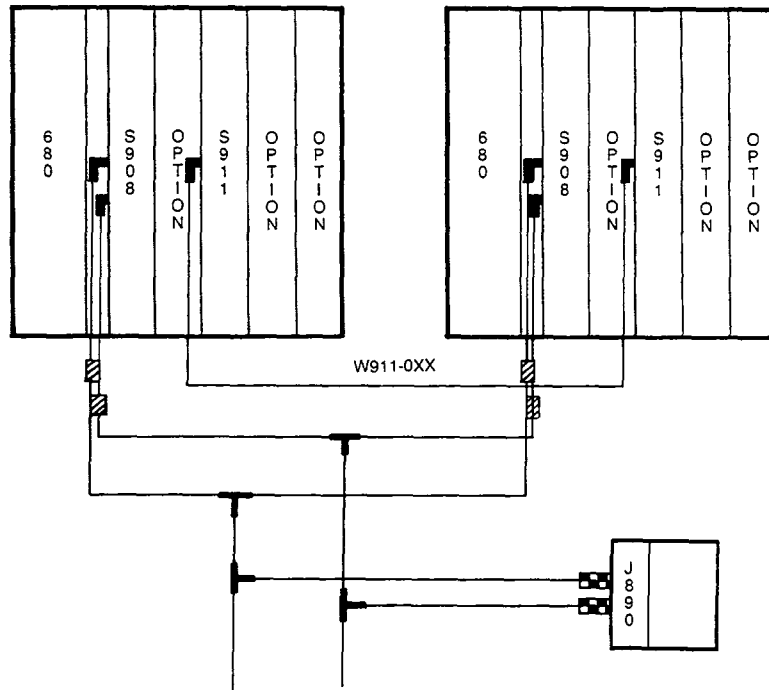

Figure 3-12

Redundant I/O Cables for a  
984-680 Hot Standby  
System



## Dual Remote I/O Cabling in an HSBY System

You can install dual remote I/O cables from each PC mainframe in a Hot Standby System to increase the reliability of primary communications. Dual cables allow you to protect communications integrity with a greater number of remote drops and without using splitters.

- ▶ **NOTE** A dual cable strategy requires a dual-port S908 processor in each PC; this is available with the 984A, 984B, and 984-680 systems. The 984X Hot Standby System does *not* support dual cabling.
- ▶ **NOTE** The **COMM ERROR** LED on the remote I/O processor goes on when you employ a dual cabling strategy. In this case, ignore the light – it does not indicate an error in communication.

Figures 3-13 through 3-15 show diagrams of the three 984 Hot Standby System configurations that implement redundant cabling to the remote I/O drops.

Figure 3-13

Dual I/O Cables for a 984A  
Hot Standby System

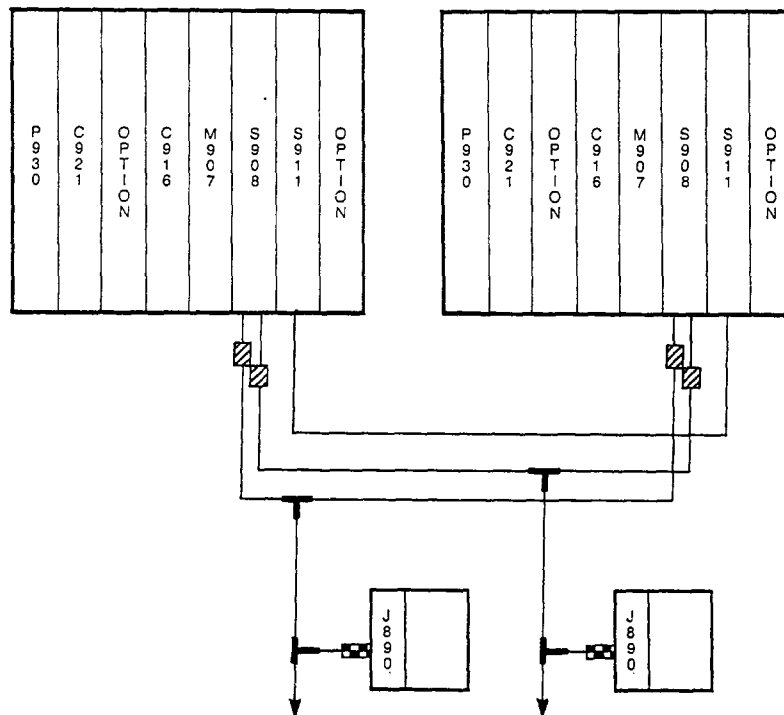

Figure 3-14

Dual I/O Cables for a 984B  
Hot Standby System

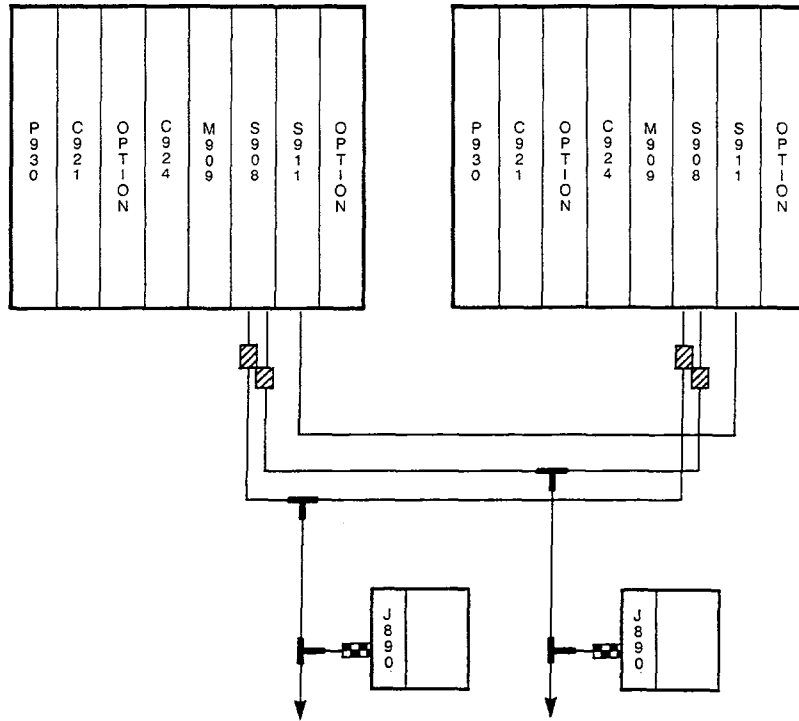
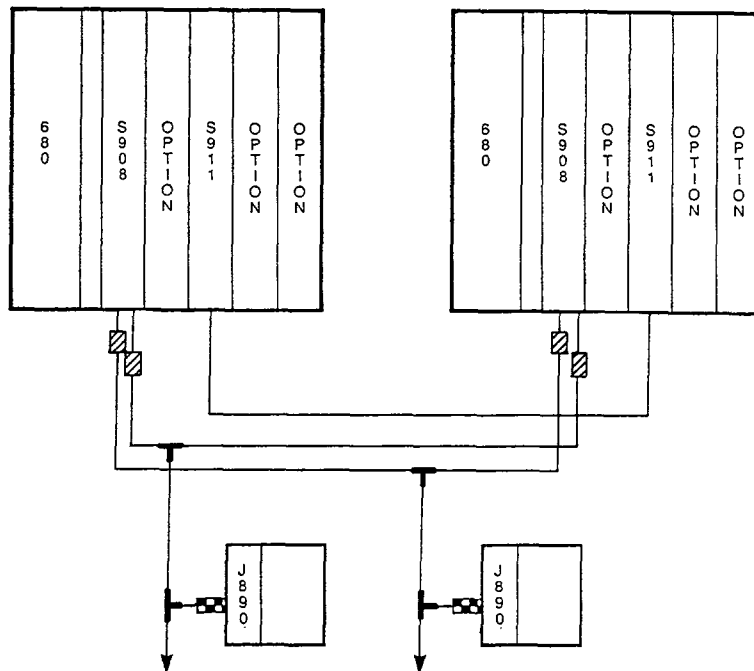

Figure 3-15

Dual I/O Cables for a  
984-680 Hot Standby  
System



## ***Installing Redundant Remote Cables***

---

### ***Procedure***     ***Installing Redundant Remote I/O Cables in an HSBY System***

- Step 1**     Run a set of I/O cables from the S908 modules in both controllers in your 984 Hot Standby System through MODICON external feed-through terminators to a line splitter. The cables must be of equal lengths of no more than 15 ft (4.57 m).
- Step 2**     Run trunk cable A from the splitter with line taps to your remote I/O drops. Terminate the end of the cable with a type TR-75F cable terminator.
- Step 3**     Open all disconnect switches in all circuits that provide power to the controllers.
- ▶ **CAUTION**   To help avoid damage to system components, de-energize the system completely before installing redundant remote I/O cables.
- Step 4**     Run another set of cables from the S908 modules in both controllers in your 984 Hot Standby System through MODICON external feed-through terminators to another line splitter. The cables must be of equal lengths of no more than 15 ft (4.57 m).
- Step 5**     Run trunk cable B from the splitter with line taps to your remote I/O drops. Terminate the end of the cable with a type TR-75F cable terminator. You will need another redundancy terminator kit.
- Step 6**     Close all system disconnect switches.
- Step 7**     Test all remote I/O cables according to the appropriate system installation guide.

## ***Installing Dual Remote Cables***

---

### **Procedure**     ***Installing Dual Remote I/O Cables in an HSBY System***

- Step 1**     Run trunk cable A from the S908 module in one of the PC mainframes in your 984 Hot Standby installation through a MODICON external feed-through terminator to a series of remote I/O drops. Terminate the end of cable A with a type TR-75F cable terminator.
- Step 2**     Open all disconnect switches in all circuits that provide power to the controllers.
- ▶ **CAUTION**     To help avoid damage to system components, de-energize the system completely before installing the dual remote I/O cables.
- Step 3**     Run a second trunk cable, cable B, from the S908 remote I/O module through MODICON external feed-through terminators to a different series of remote I/O drops. Terminate the end of cable B with a type TR-75F cable terminator. You will need another redundancy terminator kit.
- Step 4**     Run a trunk cable from the S908 processor in the second controller in your Hot Standby System to the same series of remote I/O driven by cable A from the first controller. Terminate the end of this cable with a type TR-75F cable terminator.
- Step 5**     Run another trunk cable from the second controller in your Hot Standby System to the same series of remote I/O drops driven by cable B of the first controller. Terminate the end of this cable with a type TR-75F cable terminator.
- Step 6**     Close all system disconnect switches.
- Step 7**     Test all remote I/O cables according to the appropriate system installation guide (the *984 PC System Planning and Installation Guide* for the 984A or 984B system or the *984-680 PC System Planning and Installation Guide* for the 984-680 system).





# Chapter 4

## Startup

---

After you have installed your 984 Hot Standby System according to chapter 3 of this manual and programmed it according to the *984 Hot Standby System Programming Manual* (GM-S911-002B), follow the procedures in this chapter to start your system.

- ▶ **WARNING** To help protect yourself and others against electric shock, obey the National Electrical Code and all applicable local codes and laws while designing, installing, operating, and maintaining your 984 hot standby system. The National Electrical Code is detailed in the National Fire Protection Association's publication NFPA 70-1984 (or latest edition).

## **Startup Procedures**

---

Before you begin your startup process, make sure that both controllers have been fully programmed according to the *984 Hot Standby System Programming Manual*.

### **Procedure Starting Up Your 984 Hot Standby System**

- Step 1** At the line power source, disable all voltage to both 984 controllers.
- Step 2** Remove the lower cover plates on the front panels of your power supply modules, and place both ON/OFF toggle switches in the OFF position.
- Step 3** Place the toggle switch on *one* S911 module in the A position.
- Step 4** Place the toggle switch on the *other* S911 module in the B position.
- ▶ **NOTE** Although the Hot Standby System checks these switch positions only at startup, even a brief power failure can cause problems. If both switches are in the same position, one of the controllers could fail (with its S911 COMM ERROR and PRIMARY indicators blinking).
  - ▶ **NOTE** If the controllers power up separately, the first to power up is the primary and the second is the standby.
- Step 5** Place the S911 keyswitches on *both* controllers in the RUN position.
- ▶ **CAUTION** To help avoid damage to application I/O devices through unexpected system action, make sure that both S911 keyswitches are never in the OFFLINE position at the same time.
- Step 6** Remove the keyswitch keys, and store them in a secure area. This can help you avoid accidental misoperation.
- Step 7** Enable voltage to both controllers at the line power source. The ON/OFF switches on both power supply modules should be in the OFF position.

**Step 8** Turn ON the power supply of the primary controller (the controller with its S911 keyswitch in the A position). This controller should now function as a standalone.

**Step 9** Make sure that all application I/O devices operate according to your logic ladder program. If the application is not functioning correctly, have a qualified maintenance person troubleshoot the problem (see chapter 5).

**Step 10** Turn ON the power supply module of the standby controller (the controller with its S911 keyswitch in the B position). This controller should now power up in the standby mode.

**Step 11** Look at the LED indicators on the module front panels of both controllers. If the LED's do not exhibit the normal indications shown in table 4-1, have a qualified maintenance person troubleshoot the problem (see chapter 5).

**Step 12** Replace the cover plates on your power supply modules.

Table 4-1

Hot Standby Normal  
Indications

Module	LED Indicator	Primary PC	Standby PC
S911	READY	On	On
	COMM ERROR	Off	Off
	PRIMARY	On	Off
	STANDBY	Off	On
S908/S929	READY	On	On
	COMM ACTIVE	On	Blinking
	COMM ERROR	Off	Off
C916/C924	RUN	On	On
	READY/SAFE 84	Off	Off
984-680	RUN	On	On
	READY	On	On

## ***Automatic Operation***

---

After your Hot Standby System is started and is running normally, it will continue to function automatically. It constantly tests itself for faults and is always ready to switch over if it detects a fault.

### ***Mainframe Fault Response***

If the primary controller fails, the standby automatically assumes control of the application I/O. If the primary controller recovers from the failure, it assumes standby responsibilities; if it cannot recover from the fault, it stays OFFLINE.

If the standby controller fails, it goes OFFLINE. The primary controller functions as a standalone PC and continues to manage the application I/O.

### ***Switchover Time***

Once the Hot Standby System recognizes a failure in its primary controller, the maximum switchover time that elapses before the standby assumes control is 48 ms. The exact switchover time varies depending on the location (which part of the scan or transfer) and type (which module or cable) of failure.

## **Changing System EXEC's While the System is Running**

---

If the PROM's in locations K3 and K5 on the S911 module have been upgraded to Rev. C or higher, you can change the system EXECs in your Hot Standby System without stopping the application. This is done by setting bit 12 in the HSBY command register to 1 during the change.

### **Procedure      *How to Change the System EXEC on a Running Hot Standby System***

- Step 1**      With both the primary and standby controllers in the **RUN** mode, attach your programming panel to the primary controller. Set bit 12 in the HSBY command register to 1. The bit value will copy to the standby controller during the normal register update routine.
- Step 2**      Using the keyswitch on the S911 module, switch the standby controller from **RUN** to **OFFLINE**.
- Step 3**      When the standby controller has powered down and the primary controller is running as a *standalone*, change the EXEC on the standby controller.
- Step 4**      After changing the EXEC, power the standby controller back up. When the **READY** LED goes on, switch it back into the **RUN** mode. The controller should go back into **STANDBY** mode. Both systems now contain different EXEC's.
- Step 5**      Using the keyswitch on the S911 module, switch the primary controller from **RUN** to **OFFLINE**. The standby controller should take over system control and assume the **PRIMARY** mode. It should be running as a standalone.
- Step 6**      Power down the old primary controller, and change its EXEC.
- Step 7**      After changing the EXEC, power the controller back up. When the **READY** LED goes on, switch it back into the **RUN** mode. The controller should come up in **STANDBY** mode. Both controllers now contain the new EXEC.
- Step 8**      Attach your programming panel to the new primary controller, and set bit 12 in the HSBY command register back to 0. The bit value will copy to the standby controller during the normal register update routine.

## ***Some Illegal Startup Procedures***

---

Make sure that all the cables are properly connected before you power up your Hot Standby System. If you attempt to connect cables in a system that is already running, you may not be able to get the Hot Standby capability to function.

### ***Starting a System Without Any Cables Connected***

If you attempt to start up both controllers in a Hot Standby System before any cables are connected, both controllers will come up in primary mode and neither will communicate with the I/O drops.

If you then connect an I/O cable to one controller, that controller will drive the I/O as a standalone. When you try to connect an I/O cable to the second controller, that controller will not power up properly.

If you try to connect W911 and I/O cables to two powered-up controllers, one controller will come up as a standalone and the other will not power up properly.

### ***Starting a System With Only W911 Cable Connected***

If you power up a Hot Standby System with a W911 cable connected between the two S911 modules but without an I/O cable, one controller will go OFFLINE.

### ***Trying to Connect Cable to a Running System***

If you have a controller powered up and driving I/O, you need to power it down before you attempt to give it Hot Standby capability.

If you power up a second controller and connect an I/O cable to the running controller, the second controller will not power up properly.

If you connect a W911 cable between a second controller that is powered down and a running controller, then power up the second controller, the second controller will not power up properly.

If you disconnect the I/O cable from a controller that has been driving I/O and connect the cable to another powered up controller, both controllers will remain in primary mode.

# **Chapter 5**

## **Maintenance**

---

- Automatic Confidence Tests
- Indicators of a Healthy Hot Standby System
- Automatic Error Detection
- Board-level Error Indicators
- Communication and Interface Error Indicators
- Startup Error Indicators
- Troubleshooting
- Restart After a Major Repair
- Testing a Hot Standby Switchover

## ***Automatic Confidence Tests***

---

The 984 Hot Standby System automatically performs two kinds of confidence tests on its modules – *startup* tests and *run time* tests. The discussion below considers only confidence tests performed on the S911 module.

### ***Startup Tests***

Startup confidence testing on the S911 hot standby modules is extensive. These tests attempt to detect hardware errors in the module before you enter the application software.

Your system performs five startup tests:

- PROM checksums
- RAM data
- RAM addresses
- Universal Asynchronous Receive and Transmit (UART) diagnostics
- 984-to-S911 interface

### ***Run Time Tests***

Run time tests constitute system performance overhead. Therefore, only a slice of these tests is executed in every scan or when the S911 is idle for long intervals. Each slice is limited to 50 microseconds.

The Hot Standby System performs three kinds of run time confidence tests:

- PROM checksums
- RAM data
- RAM addresses



# Indicators of a Healthy Hot Standby System

If the automatic confidence tests do not detect any errors, the LED's on the front panels of your S911 hot standby modules and your remote I/O processors will display the following pattern.

Figure 5-1

Indicators of a Healthy Hot Standby System

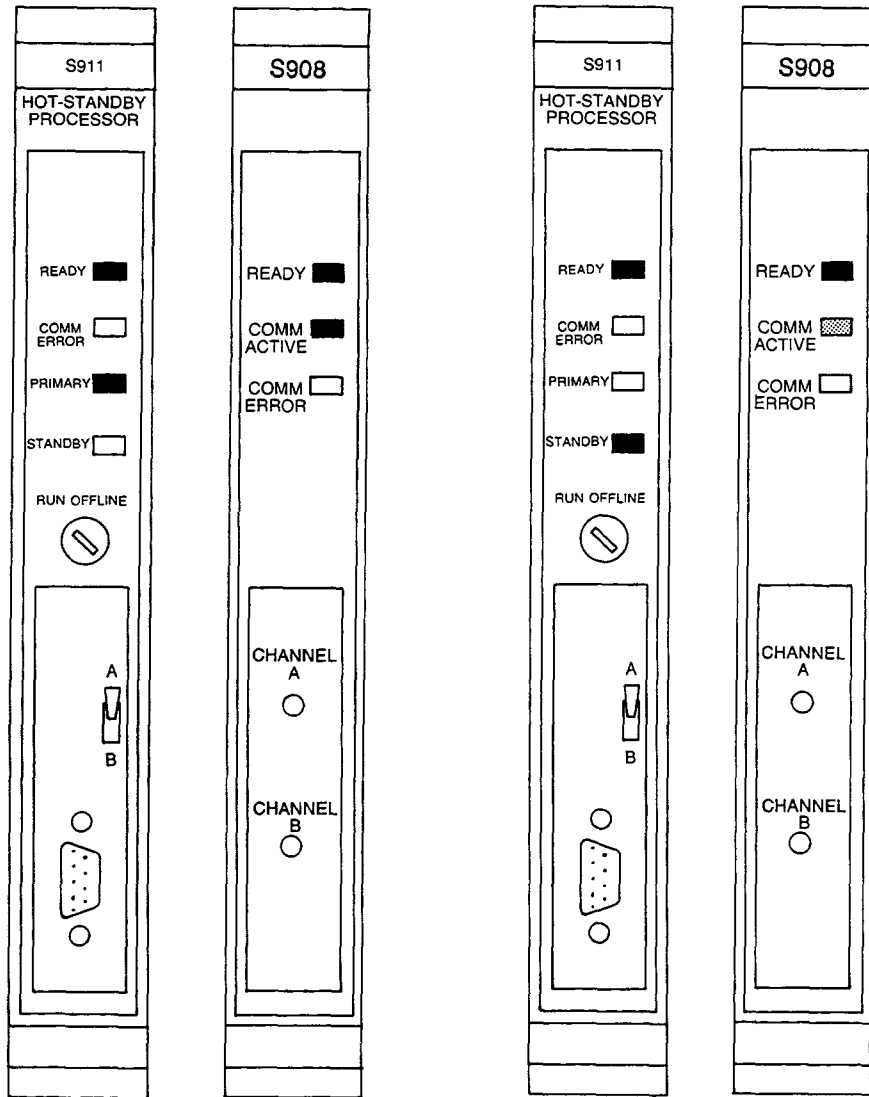
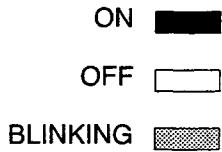

PRIMARY

STANDBY

## ***Automatic Error Detection***

---

Whenever a confidence test reveals an error in an S911, that error is fatal. The LED displays on the control panel of the S911's in your system can help locate the source of the failure.

### ***Detecting Fatal Errors***

When an S911 hot standby module experiences an error, it takes its controller OFFLINE. It does not communicate with the other S911, and it does not transfer data to or from its controller.

### ***LED Error Indicators***

The LED's on the front panel of the S911's can help you locate the source of your errors. The display pattern tells you which controller is experiencing problems and what kind of error is occurring.

There are four categories of errors associated with the Hot Standby System:

- Board-level errors
- Communication errors
- 984 interface errors
- Startup errors

### ***Checking Startup Error Codes***

If your LED's indicate a startup error and the source of that error is not easy to pinpoint, you can access some startup error codes in the system software. The procedures are described in chapter 8 of the *984 Hot Standby System Programming Manual*.

# Board-level Error Indicators

The figures below show LED displays that indicate the four types of board-level errors: PROM checksum error, RAM data error, RAM address error, and parity error. If you encounter one of these errors, replace the S911 module.

Figure 5-2

**PROM Checksum Error**

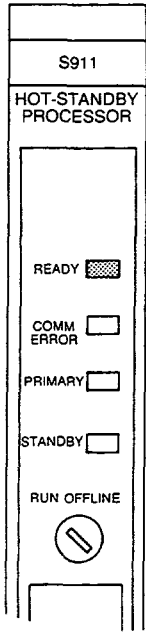

Figure 5-3

**RAM Data Error**

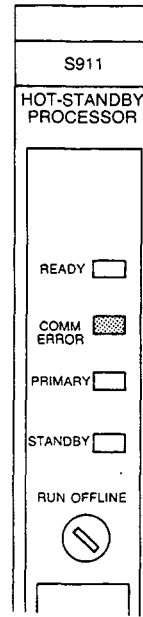
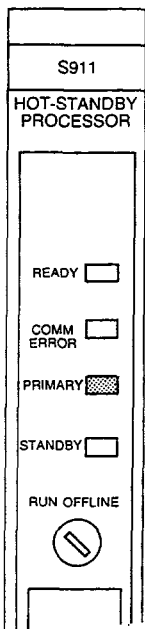

Figure 5-4

**RAM Address Error**



OFF   
 BLINKING

Figure 5-5

**Parity Error**

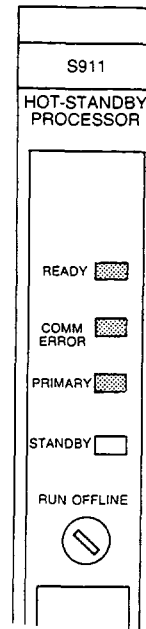

# Communication and Interface Error Indicators

The figures below show LED displays that indicate communication-related errors and errors due to the 984-to-S911 interface.

Figure 5-6

Communication Error



Figure 5-7

Interface Error

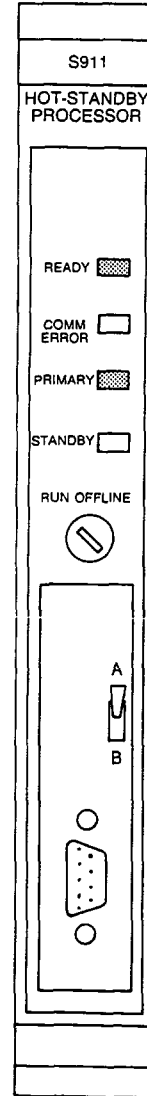

OFF   
BLINKING

# Startup Error Indicators

The figure below shows an LED display that indicates a startup error problem. Startup errors can result from the toggle switches on the two S911 being set in the same position, differences in the Traffic Cop, differences in the configuration tables, or differences in the Segment Scheduler in the primary and standby controllers.

The LED's also display this pattern when the memory board sizes in the two systems are different or when the systems are using different option modules (or if an option module is not working properly in one of the two systems).

Figure 5-8

Startup Errors

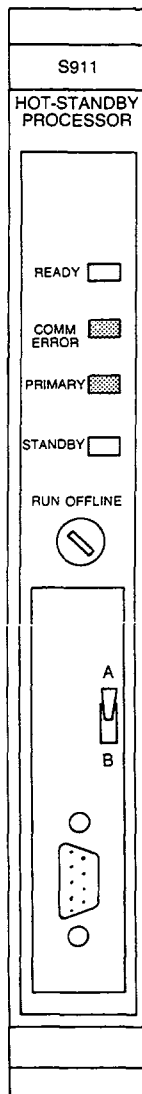

## **Troubleshooting**

---

Table 5-1 lists some of the actions to be taken when you encounter errors in your Hot Standby System. Before you take any action, be aware of the following cautions and warnings.

### ***Troubleshooting Precautions***

- ▶ **WARNING** To help protect yourself and others against electric shock, allow no one to touch energized high voltage circuits (such as 115V AC). Before connecting or disconnecting any high voltage component, open and padlock open the disconnect switch that provides power to that component.
- ▶ **CAUTION** To help avoid damage to system modules, do not remove or insert any module without first turning off the mainframe or I/O chassis that contains that module.
- ▶ **CAUTION** To help avoid damage to application I/O devices through unexpected system action while disconnecting any remote I/O cable, disconnect only the feed-through terminator from the module, leaving the terminator connected to its cable.
- ▶ **NOTE** Before you replace any module in either mainframe, make sure that the spare module is compatible with your Hot Standby System. Make sure also that you use the correct terminator.

Table 5-1

Troubleshooting Hot  
Standby Fault Indications

<b>Error Type</b>	<b>Action</b>
Board-level	Replace the S911 module.
Communication between S911's	<ol style="list-style-type: none"><li>1. Make sure the cables are connected properly and are functioning correctly.</li><li>2. If the cables are okay, check the communication lines for excess noise.</li><li>3. If the communication lines are okay, replace the S911 module.</li></ol>
984 Interface	<ol style="list-style-type: none"><li>1. Disable the HSBY function block and restart the system. If the problem goes away, you know the problem is in the S911 module.</li><li>2. If the problem still occurs, replace each component, one at a time.</li><li>3. If the problem still occurs, replace the chassis.</li></ol>
Startup	<ol style="list-style-type: none"><li>1. Make sure your toggle switches on the two S911 modules are in different positions.</li><li>2. Make sure your configuration tables are identical in both mainframes.</li><li>3. Make sure your segment schedulers are identical in both mainframes.</li><li>4. Make sure the Traffic Cops are identical in both mainframes.</li></ol>

## ***Restart After a Major Repair***

---

If you have had to power down your system to make a major repair, follow the procedures in chapter 4 of this manual to restart the system.

If you have made only a simple repair, you may not need to follow this procedure. For example, if you have only reconnected a loose cable and cycled power at one controller, all you need to do is make sure that both controllers display normal indications.



## **Testing Hot Standby Switchover**

---

You may test the switchover function of your hot standby system at any time by following the procedure in this section.

### **Procedure Switchover Test**

- Step 1** Make sure that the S911 toggle switch on one controller is in the A position and that the other S911 toggle switch is in the B position.
- Step 2** Retrieve an S911 (or optional control panel) keyswitch key from its secure storage area.
- Step 3** Make sure the LED's on the module front panels in both controllers exhibit normal indications.
- Step 4** Place the S911 RUN/OFFLINE keyswitch (or optional system control switch) on the primary controller in the OFFLINE position. The READY LED stays on, and all other LED's go off.
- Result** The standby controller should switch to primary mode and function as a standalone controller.
- Step 5** Return the S911 keyswitch (or optional system control switch) on the OFFLINE controller to the RUN position. The READY and STANDBY LED's should go on.
- Result** The OFFLINE controller should start running in the standby mode, and the new primary controller should continue running in the primary mode.
- Step 6** Make sure the LED's on the module front panels in both controllers exhibit normal indications, with the primary and standby states switched over.
- Step 7** Return the S911 (or optional control panel) switch key to a secure storage area.



# **Appendix A**

## **S911 Module Specifications**

---

- Electrical Characteristics
- Environmental Characteristics
- Power Consumption
- Scan Time Characteristics
- Switchover Time

# **S911 Specifications**

---

## **Electrical Characteristics**

Static Discharge	15 kV to all surfaces
Magnetic	20 Gauss field inside Helmholtz Coil, 0.25 – 8 pps
Agency Approval	Designed to meet applicable agency safety requirements

## **Environmental Characteristics**

Temperature	Operating: 0° – 60°C Storage: – 40 – + 80°C
Humidity	0–95% Noncondensing
Altitude	10,000 ft max
Shock	± 10 g, 11 ms, 3 pulses/axis
Vibration (Operating)	5 – 50 Hz @ .005 in D.A., 30 min/axis 50 – 500 Hz @ .625 g, 30 min/axis
Vibration (Not Operating)	10 – 50 Hz @ .029 g/Hz 50 – 300 Hz @ .029 g/Hz, – 8 dB/octave

## **Power Consumption**

S911-000	1.98 A @ +5 VCC
S911-800	1.16 A @ +5 VCC

### ***Minimum Scan Time Characteristics***

State RAM to Primary S911	3 ms + 1.3 ms/K of configured state RAM
Worst case	7 ms for the 984A, 984X, and 984-680 20 ms for the 984B
S911 to S911	2.6 ms/K of configured state RAM for the S911-000; 5.2 ms/K of configured state RAM for the S911-800
Worst Case	8 ms for the 984A and 984X 16 ms for the 984-680 33 ms for the 984B

### ***Switchover Time***

13 – 48 ms from the time a fault is detected in the primary controller



# Index

---

- A** automatic confidence tests
  - run time 5-2
  - startup 5-2, 5-4
- B** BNC connectors 3-7
  - board-level errors 5-5, 5-9
- C** chassis
  - four-slot 3-4
  - seven-slot 3-2
  - communication errors 5-6, 5-9
  - compatibility of system
    - components 2-4
  - confidence tests (see automatic confidence tests)
- D** dual cabling option 1-9, 2-6, 3-14 – 3-15
- E** electrical A-2
  - electric shock 2-3, 4-1
  - environment 2-2, A-2
  - error codes (see startup error codes)
- F** fault response 4-4
- H** Hot Standby System (see 984A, 984B, 984X, 984-680, HSBY function block)
  - housings for the 984-680
    - H819 3-5
    - H827 3-5
  - HSBY function block 1-2
- I** installation procedure
  - dual cabling 3-12 – 3-13
  - Hot Standby 3-8 – 3-9
  - interface errors 5-6, 5-9
- K** keyswitches 1-7, 4-2
- L** light emitting diode (LED)
  - board-level errors 5-5
  - communication errors 5-6
  - interface errors 5-6
  - remote I/O processor 1-9
  - startup errors 5-7
  - S911 module 1-7
  - valid startup 4-3, 5-3
  - local I/O restriction 2-2
- M** minimum hardware configuration 1-4
- O** optional system control techniques 2-3, 2-6
  - option modules 1-5
  - option slots (see chassis)
- P** planning guidelines
  - general 2-2
  - new Hot Standbys 2-3
  - retrofit systems 2-4 – 2-5
  - power supply (P930/P933) 1-5, 2-5, 3-2 – 3-4, A-2
  - primary controller 1-2, 4-4
- R** redundancy 1-2
  - redundancy terminator kit 1-4, 3-6 – 3-7
  - redundant cables 1-9, 3-12

- reliability 1-2
  - remote I/O processor
    - S908-0XX 1-8
    - S908-110 1-8
    - S929 1-8
  - restart after major repair 5-10
- S**
- scan time A-3
  - shrink wrap tubes 3-6 – 3-7
  - soft control 2-5
  - specifications
    - electrical A-2
    - environmental A-2
    - power consumption A-2
    - scan time A-3
    - switchover time A-3
  - splitter 3-6 – 3-7
  - standby controller 1-2, 4-4
  - startup
    - errors 5-7, 5-9
    - illegal procedures 4-6
    - procedures 4-3 – 4-3
  - startup error codes 5-4
  - switchable states 1-2, 4-4
  - switchover
    - defined 4-4
    - test procedure 5-11
  - S911 Hot Standby module 1-2
    - S911-000 1-6
    - S911-800 1-6
- T**
- terminator 3-6 – 3-7
  - toggle switch 1-7
  - troubleshooting startup errors 5-8 – 5-9
- U**
- upgrading an EXEC pack 4-5
- W**
- W911 cable 1-5, 1-7
- #**
- 984A
    - compatibility 2-4
    - dual cabling 3-14
    - installation 3-8 – 3-9
    - mainframe 1-4, 3-2
    - system diagram 3-10
    - user part numbers 1-10
  - 984B
    - compatibility 2-4
    - dual cabling 3-14
    - installation 3-8 – 3-9
    - mainframe 1-4, 3-3
    - system diagram 3-10
    - user part numbers 1-10
  - 984X
    - compatibility 2-4
    - installation 3-8 – 3-9
    - mainframe 1-4, 3-4
    - system diagram 3-11
    - user part numbers 1-11
  - 984-680
    - compatibility 2-4
    - dual cabling 3-15
    - installation 3-8 – 3-9
    - mainframe 1-4, 3-5
    - system diagram 3-11
    - user part numbers 1-11



# Publications Comment Form

Document Part Number GM-S911-001 Rev B

Title 984 Hot Standby Sys. Install. & Maint.

We are constantly striving to improve the content and usability of our technical documents. You can help us by answering the questions below and mailing this form to us. Also, if you find any errors or have any suggestions for improvement, please let us know.

**How do you use this document?**

- Introduction to the product
- Classroom resource
- Self-study
- Programming Procedures
- Advanced programming techniques
- Operating instructions
- Reference
- Other \_\_\_\_\_

**How did you get this document?**

- Received with equipment
- Received from Sales or Customer Service Representative
- Ordered from MODICON
- Do not know
- Other \_\_\_\_\_

**Please rate this document.**

		Excellent	Very Good	Good	Fair	Poor
<b>Technical Accuracy</b>	- Does the system work the way it is described in the manual?	<input type="checkbox"/>	<input type="checkbox"/>	<input type="checkbox"/>	<input type="checkbox"/>	<input type="checkbox"/>
<b>Readability</b>	- Is the manual easy to read and understand?	<input type="checkbox"/>	<input type="checkbox"/>	<input type="checkbox"/>	<input type="checkbox"/>	<input type="checkbox"/>
<b>Clarity</b>	- Are the instructions easy to follow?	<input type="checkbox"/>	<input type="checkbox"/>	<input type="checkbox"/>	<input type="checkbox"/>	<input type="checkbox"/>
<b>Examples</b>	- Are the examples helpful and realistic? Are there enough examples?	<input type="checkbox"/>	<input type="checkbox"/>	<input type="checkbox"/>	<input type="checkbox"/>	<input type="checkbox"/>
<b>Organization</b>	- Is the organization of the manual logical? Is it easy to find what you are looking for?	<input type="checkbox"/>	<input type="checkbox"/>	<input type="checkbox"/>	<input type="checkbox"/>	<input type="checkbox"/>
<b>Illustrations</b>	- Are the illustrations clear and useful?	<input type="checkbox"/>	<input type="checkbox"/>	<input type="checkbox"/>	<input type="checkbox"/>	<input type="checkbox"/>
<b>Physical Attractiveness</b>	- What did you think of the layout, printing, binding, etc?	<input type="checkbox"/>	<input type="checkbox"/>	<input type="checkbox"/>	<input type="checkbox"/>	<input type="checkbox"/>

Are there any terms or concepts that are not defined clearly? Y  N   
If so, what are they? \_\_\_\_\_

After reading this document, are you able to use the equipment? Y  N

What errors did you find in the manual? (Please include page numbers. Attach an extra sheet if necessary.)  
\_\_\_\_\_

Do you have any comments or suggestions? \_\_\_\_\_

Name \_\_\_\_\_ Street \_\_\_\_\_  
 Title \_\_\_\_\_ City \_\_\_\_\_  
 Dept./Mail Stop \_\_\_\_\_ State/Country \_\_\_\_\_  
 Company \_\_\_\_\_ Zip Code \_\_\_\_\_ Telephone \_\_\_\_\_

Thank you for your help.

CUT ALONG LINE

CUT ALONG LINE  
FOLD ALONG LINE  
FOLD ALONG LINE



NO POSTAGE  
NECESSARY  
IF MAILED  
IN THE  
UNITED STATES

**BUSINESS REPLY MAIL**  
FIRST CLASS PERMIT NO. 234 ANDOVER, MA

Postage will be paid by addressee:

MODICON, Inc.  
1 High Street  
North Andover, MA 01845-9943

Attn: Technical Publications 7-2A



# Publications Order Form

TO ORDER BY PHONE, CALL  
**1-800-468-5342** and ask  
for an Order Entry Coordinator

<b>Bill To:</b>	<b>Ship To: (if different):</b>

	<b>Customer Contact</b>
	Name: _____
Purchase Order No. _____ Date _____	Telephone: _____

Document Part Number	Description	Quantity	Unit Price	Total Price

	Sub Total	
Authorized Signature _____ Date _____	Freight	
	Total	

**Ordering Instructions**

1. Provide appropriate billing address and shipping address (if different from billing address).
2. Please provide a contact name and phone number in case we have a question about your order.
3. Indicate your purchase order number and date. (You may prepay by enclosing a check for the full amount.)
4. Give the part number, description, and quantity for each document ordered.

**Delivery**

Unless otherwise specified, all orders are shipped best way surface, F.O.B. Andover, MA (prepay and add if UPS surface, collect for truck and air). If you specify insurance, you will be billed for these changes. MODICON will not assume any liability in connection with the shipment nor shall the carrier be construed to be an agent of MODICON.

**Payment**

Terms are net 30 days from date of invoice. Unless otherwise stated, partial shipments will generate partial invoices.

**Prices**

Prices are subject to change without notice. Individual prices can be found in the Publications Catalog or obtained by calling an Order Entry Coordinator at 1-800-468-5342.

CUT ALONG LINE

CUT ALONG LINE



NO POSTAGE  
NECESSARY  
IF MAILED  
IN THE  
UNITED STATES

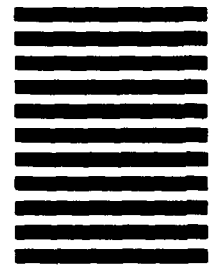

**BUSINESS REPLY MAIL**  
FIRST CLASS PERMIT NO. 234 ANDOVER, MA

Postage will be paid by addressee:

MODICON, Inc.  
1 High Street  
North Andover, MA 01845-9943

Attn: Order Entry 3-2B









Modicon, Square D and Telemecanique are PLC brand names from Schneider. These products are sold in the US by Square D, in Canada, Latin America, Europe, Africa, Asia/Pacific and Middle East by Schneider, in Germany by AEG Schneider Automation, in China and Persian Gulf by Schneider Automation, in South Africa by ASA Systems Automation, in Austria by Online.

Schneider Automation, Inc.  
One High Street  
North Andover, MA 01845  
Tel: (1) 508-794-0800  
Fax: (1) 508-975-9400

Schneider Automation GmbH  
Steinheimer Strasse 117  
D-63500 Seligenstadt  
Tel: (49) 6182 81-2584  
Fax: (49) 6182 81-2860

Schneider Automation S.A.  
245, Route des Lucioles-BP147  
F-06903 Sophia-Antipolis Cedex  
Tel: (33) 92 96 20 00  
Fax: (33) 93 65 37 15